

UCSC Farm & Garden Apprenticeship

University of California, Santa Cruz

Teaching Organic Farming & Gardening

RESOURCES *for* INSTRUCTORS



Edited by Martha Brown, Jan Perez,
and Albie Miles



3RD EDITION *Revised & Expanded*



The CENTER for AGROECOLOGY
& SUSTAINABLE FOOD SYSTEMS

The Center for Agroecology & Sustainable Food Systems is a research, education, and public service program located at the University of California, Santa Cruz. The Center's mission is to advance sustainable food and agricultural systems that are environmentally sound, economically viable, socially responsible, nonexploitative, and that serve as a foundation for future generations.

For ordering information contact:

CASFS
1156 High St.
UC Santa Cruz
Santa Cruz, California 95064
831.459-3240, casfs@ucsc.edu
casfs.ucsc.edu/about/publications

ISBN 978-0-9828781-0-1
©2015 Center for Agroecology & Sustainable Food Systems
University of California, Santa Cruz
Santa Cruz, California
casfs.ucsc.edu
First edition published 2003, second edition published 2005

Cover photo credits (clockwise from top): Abigail Huetter; Damian Parr; CASFS collection; Brandon Blackburn

Title page photo credits: Abigail Huetter (top); Damian Parr

Unit 2.1, Soil Physical Properties: Diagrams and figures are from *Minerals in Soil Environments*, by Dixon et al., and are used by permission of the Soil Science Society of America. A Flow Diagram for Teaching Soil Texture by Feel Analysis, by Thein, J., is from *The Journal of Agronomic Education*, Vol. 8, 1979, p. 54. All other illustrations and tables are compiled from the USDA Natural Resources Conservation Service. Unit 2.2, Soil Chemistry and Fertility: The carbon and nitrogen illustrations are adapted from Michigan State University Extension Bulletin E-2646, *Michigan Field Crop Ecology*. The phosphorus illustration is used courtesy of Minnesota Extension publication *The Nature of Phosphorus in Soils*, Copyright 2002. www.extension.umn.edu. The potassium illustration is used by permission of IMC Global.

No endorsement of names, illustrated products, or suppliers is intended, nor is criticism implied of similar products or suppliers that are not mentioned or illustrated.

Table of Contents

Foreword	v
About CASFS and the Farm & Garden Apprenticeship	vi
Preface	vii
Acknowledgments	viii
Contributors and Reviewers	ix
How To Use This Resource	xii
Part 1 Organic Farming and Gardening Skills and Practices	
Unit 1.1 Managing Soil Health	1–3
Unit 1.2 Garden and Field Tillage and Cultivation	1–31
Unit 1.3 Propagating Crops from Seed, and Greenhouse Management	1–95
Unit 1.4 Transplanting and Direct Seeding	1–165
Unit 1.5 Irrigation—Principles and Practices	1–203
Unit 1.6 Selecting and Using Cover Crops	1–263
Unit 1.7 Making and Using Compost	1–295
Unit 1.8 Managing Arthropod Pests	1–341
Unit 1.9 Managing Plant Pathogens	1–371
Unit 1.10 Managing Weeds	1–393
Unit 1.11 Reading and Interpreting Soil Test Reports	1–429
Part 2 Applied Soil Science	
Unit 2.1 Soils and Soil Physical Properties	2–3
Unit 2.2 Soil Chemistry and Fertility	2–49
Unit 2.3 Soil Biology and Ecology	2–83
Part 3 Social and Environmental Issues in Agriculture	
Unit 3.1 The Development of U.S. Agriculture	3–3
Unit 3.2 Social Issues in Modern Agriculture	3–31
Unit 3.3 Environmental Issues in Modern Agriculture	3–53
Unit 3.4 Sustainable Agriculture and Sustainable Food Systems	3–73

Foreword

You have before you a document that is as unique and revolutionary as it is useful. It is unique, because it draws upon nearly five decades of actual teaching practice in organic methods of growing plants. Over 1,500 apprentices at the Center for Agroecology & Sustainable Food Systems (CASFS, the Center) at the University of California, Santa Cruz have learned the methods described in this manual and applied them in settings as diverse as commercial organic farms, urban and school gardens, college and university farms, and overseas food projects. I can think of no other organic growing pedagogy that has been so thoroughly time- and field-tested.

This manual is revolutionary, because of how dominant the chemical- and resource-intensive paradigm for growing plants has become. As the world population grows and our climate changes, agricultural and food systems are ever more stressed and will be so for years to come. Diversified farming systems employing the techniques described in this manual absolutely can feed the world, as many studies continue to prove. If the future of food and agriculture is at all sustainable and just, it is far more likely to employ the methods in this manual than so-called conventional agricultural techniques.

But perhaps most important for you, our readers, this manual is useful because it works. The practices described here can be employed in a variety of climates, soils, and educational settings. The information on soil science provides a solid grounding for the practices described, and the units on social and environmental

issues offer a broader context for those interested in sustainable agriculture.

Moreover, teaching organic farming and gardening has evolved dramatically over the last several decades. In contrast to the very early efforts at organic farming and gardening, a substantial body of agroecological research informs today's organic practices. Similarly, dramatic expansion in commercial applications of these techniques also confirms that they work, while simultaneously being modified for improvements. Today, those interested in teaching and learning about organic farming and gardening have a wealth of resources from which to draw, including this curriculum.

In the spirit of the University of California's dedication to public service, this manual is downloadable free of charge. Its many contributors are all grateful for the opportunity to share their experience, passion, and dedication as widely as possible.

Whether you are a long-time farmer educator, new farmer instructor, seasoned grower working a large farm, or a novice urban gardener, I thank you for your interest and trust. I fervently hope that this manual will help you teach others, learn on your own, and beautify your patch of the world.

– Daniel Press

*Olga T. Griswold Professor of
Environmental Studies
Executive Director, Center for Agroecology
& Sustainable Food Systems
University of California, Santa Cruz*

The Center for Agroecology & Sustainable Food Systems, and the Farm & Garden Apprenticeship

The Center for Agroecology and Sustainable Food Systems (CASFS, the Center) is a research, education, and public service unit of the Division of Social Sciences at the University of California, Santa Cruz, dedicated to increasing ecological sustainability and social justice in the food and agriculture system. Center research and education efforts seek to increase understanding of the social, economic, political, and ethical foundations of agricultural sustainability; to establish the ecological and agronomic basis for sustainable production systems; and to demonstrate and facilitate the use of information critical to the adoption of sustainable food and agriculture systems.

The Center's work covers a spectrum that includes academic education and practical training, theoretical and applied research, and public service for audiences ranging from international grower groups to local school children. The Center's 3-acre Alan Chadwick Garden and the 33-acre UCSC Farm are unique organic demonstration, education, and research sites on the UCSC campus.

The Farm & Garden Apprenticeship is a six-month training program held annually at the Center's farm and garden sites. Initiated by Alan Chadwick in 1967, this full-time course now brings participants of all ages from around the world to learn the basic skills of organic gardening and farming, while also studying the complex social and environmental issues surrounding sustainable agriculture and food systems. The program combines classroom instruction, small group demonstrations, and readings with hands-on learning in the fields, gardens, greenhouses, and orchards. The main instructors in the Apprenticeship course are the Farm Manager, the two Garden Managers, and the Community Supported Agriculture (CSA) Manager who work daily alongside the apprentices, present classes, and lead training sessions. UCSC faculty, researchers, and members of the agricultural community add a wide range of expertise to the course.

To date nearly 1,500 apprentices have completed the Apprenticeship training program. Graduates have established their own commercial farms and market gardens, run community gardens for inner city and prison populations, and developed school garden programs. Many graduates take part in international develop-

"There are very few programs that provide an academic component to the very real world of organic agriculture. This [Apprenticeship] program ranks among the very best in the nation thanks to the skill of the instructors, the diversity of the students, and the certified organic gardens and fields themselves."

—Bob Scowcroft, *Founding Director*
Organic Farming Research Foundation

ment and food security projects. Others have raised the standards of the organic food industry through work with certification programs and retailers. One of the most important outcomes of the Apprenticeship is the ripple effect our graduates have working locally, nationally, and internationally to practice, promote, and teach sustainable, organic farming and gardening.

Our on-campus farm and garden are open to the public year-round. Thousands of visitors come annually to see the hundreds of varieties of annual vegetable and flower crops, fruit trees, and perennial plantings, and to learn about sustainable growing methods, research projects, and education programs. Also based at the UCSC Farm, the non-profit group Life Lab hosts pre-K-12 science, nutrition, and environmental education programs, and the "Food, What?!" youth empowerment program. In conjunction with our support group, the Friends of the UCSC Farm & Garden, the Center offers a year-long series of organic gardening classes, workshops, and seasonal celebrations for the community.

For more information on the Center and its activities, contact us at:

CASFS
1156 High Street
University of California
Santa Cruz, CA 95064
831.459-3240
casfs@ucsc.edu
and visit our website, casfs.ucsc.edu

For questions about the Apprenticeship in Ecological Horticulture program, see the Center's website, casfs.ucsc.edu and www.growafarmer.org, or contact us at 831.459-3240, casfs@ucsc.edu.

Preface

T*eaching Organic Farming & Gardening: Resources for Instructors* was first produced in 2003 in response to the many requests from those interested in the curriculum offered each year by the Apprenticeship in Ecological Horticulture (see page vi) through the Center for Agroecology & Sustainable Food Systems (CASFS, the Center) at the University of California, Santa Cruz. A second edition with updated information and resources followed in 2005.

Since its publication and online posting, the training manual has seen widespread use in classrooms and farm fields from California to Vermont, as well as internationally. College and university educators, apprenticeship teachers, Master Gardener trainers, and other instructors have used the lectures, hands-on exercises, and supporting material to teach basic organic farming and gardening skills, along with the concepts of soil science and social issues as they relate to sustainable agriculture. Tens of thousands have purchased print copies or viewed and downloaded the curriculum for free from the CASFS website, the University of California's eScholarship Repository, and other online postings such as the USDA's Start2Farm website. Many have thanked us for making this material available, noting the comprehensive approach it offers.

Much has changed in the past decade. There's a growing recognition of the need to bring more people into farming as the farmer population ages and the pool of farms and food producers shrinks. There are more resources, training materials, and support for those interested in farming as a career, thanks in large part to projects funded by the USDA's Beginning Farmer and Rancher Development Program (BFRDP), and organizations such as the National Young Farmers Coalition, FarmLink, and the Greenhorns Project.

Myriad new opportunities to learn about agriculture both in and out of the classroom have emerged since 2003. More and more colleges and universities are adding hands-on farmer training to their offerings. The Sustainable Agriculture Education Association (SAEA) was founded to help promote innovative educational approaches to teaching sustainable agriculture. Apprenticeships, internships, farm incubators,

and related efforts such as Collaborative Regional Alliances for Farmer Training (CRAFT) are springing up on farms across the country to serve those exploring a career in agriculture.

Farming's landscape, language, and demographics have changed as well. With "urban farming" now part of the vernacular, agriculture has spread beyond its rural roots: now New York City has its own farmer training project, San Francisco's municipal code encourages urban "micro farms," and Chicago has a vibrant commercial urban agriculture program. With concerns over climate change on the rise, the term "resilient" has joined "sustainable," "organic," and "diversified" in discussions of the type of agriculture we need to encourage. And many who are interested in agriculture and building healthy communities come from non-farming backgrounds with no hands-on experience.

The new edition of *Teaching Organic Farming & Gardening: Resources for Instructors*, was developed with this growing audience and evolving agricultural framework in mind. Through lectures, demonstrations, and exercises that can be tailored for use in the field, the garden, or the classroom, it offers comprehensive lessons from the "core" curriculum taught annually through the CASFS Apprenticeship, with an emphasis on developing basic organic farming and gardening skills for small- and medium-scale organic mixed vegetable operations. It also recognizes agriculture's social component and the increased interest in equity and justice in the food system, with new material on the social impacts of the current agricultural system and information on food justice activities.

Other new features include narrative supplements that expand on the updated lecture outlines, along with new appendices, illustrations, and resource listings. As with earlier editions, all of the written material is available free online, enhanced by Powerpoint and video to accompany many of the units (available at casfs.ucsc.edu/about/publications). We plan to continue updating and revising the curriculum and look forward to your feedback in helping us improve this resource.

Acknowledgments

T*eaching Organic Farming & Gardening: Resources for Instructors* represents nearly fifty years of experience teaching organic farming and gardening skills, soil sciences, and social issues in agriculture at the Apprenticeship in Ecological Horticulture at UC Santa Cruz. The 2003 and 2005 editions of the training manual provided the opportunity to share this experience with a broader audience.

In developing this updated and expanded edition, editors Martha Brown and Jan Perez had the chance build on the vision and efforts of original editor and author Albie Miles, and to enhance the lectures, demonstrations, and hands-on exercises based on feedback and insights from many instructors, apprentices, and students.

At the heart of this effort have been the dedicated teachers, researchers, farmers, and Apprenticeship graduates who wrote, revised, and reviewed the various units (see Contributors & Reviewers, next page). These already busy people were asked to add even more work to their overflowing schedules, and we are grateful to them for the many hours they committed in bringing this project to fruition.

Thanks go also to many other contributors: Jane Bolling of Jane Bolling Design created the cover and updated the layout. Science illustrators Jose Miguel Mayo and Catherine Genetti Reinhard created the original line art for Parts 1 and 2. Photographers

Abigail Huetter and Brandon Blackburn took many of the photos for the accompanying online Powerpoint presentations. Jessica Beckett Parr, Hillary Terashima, and Jim Clark created the online videos. Daniel Wu updated many of the resources.

We thank Daniel Press, Executive Director of the Center for Agroecology & Sustainable Food Systems, for his support throughout this project. And a very special thank you to Amy Bolton for the many hours of skillful work and insights required to lay out and proof more than 700 pages of materials.

The Center's grant writer Ann Lindsey brought in the funding for the training manual revision effort and helped shape and guide it along the way. This project would not have been possible without the generous funders who provided their support for the revised and expanded training manuals: Gaia Fund, the USDA Beginning Farmer and Rancher Development Program, Western Sustainable Agriculture Research and Education (WSARE), the Joseph and Vera Long Foundation, and the Eucalyptus Foundation. Funding for the project's initial development came from the True North Foundation, the Arkay Foundation, the Foundation for Sustainability and Innovation, the Organic Farming Research Foundation, Richard and Rhoda Goldman Fund, The Mary A. Crocker Trust, The Foxwhelp Group of the Tides Foundation, The Kellogg Foundation through the California Food and Fiber Futures Project, and John Kinder.

Contributors and Reviewers

CONTRIBUTORS

CHRISTOF BERNAU (*Propagating Crops from Seed, and Greenhouse Management; Irrigation—Principles and Practices*)

Christof Bernau, the Center's Farm Garden Manager, oversees the demonstration and production garden, managing the greenhouse facilities and nursery production, and helps steward the social justice components of the Apprenticeship curriculum as well as teaching a range of horticulture classes for apprentices, UCSC students, and the general public.

MARTHA BROWN (*Editor*)

Martha Brown, the Center's Principal Editor, writes, edits, and designs the Center's publications, along with managing the Center websites and other outreach efforts.

SKY DE MURO-MILLER (*Garden and Field Tillage and Cultivation; Transplanting and Direct Seeding; Making and Using Compost*)

Sky De Muro-Miller is a Garden Instructor at the UCSC Farm & Garden, where she helps manage the Chadwick Garden with Orin Martin. She also organizes and teaches workshops for the public and for beginning farmers on the Central Coast.

JILL HARRISON (*Social Issues in Modern Agriculture*)

Jill Harrison is an Assistant Professor in the Department of Sociology at the University of Colorado, Boulder, where she focuses on environmental sociology and the sociology of agriculture and food. She received her PhD from UCSC's Department of Environmental Studies.

ERIC HOLT-GIMÉNEZ (*Sustainable Agriculture and Sustainable Food Systems*)

Eric Holt-Giménez, PhD, is Executive Director of Food First, a non-profit "people's think tank" dedicated to ending the injustices that cause hunger and helping communities to take back control of their food systems through research, education and action. He has spent 25 years working with farmers in Central America and Mexico, writing on social movements and social justice in the food system, and teaching development studies.

JIM LEAP (*Garden and Field Tillage and Cultivation; Irrigation—Principles and Practices; Selecting and Using Cover Crops; Managing Weeds; Reading and Interpreting Soil Test Reports*)

Jim Leap, past Farm Manager for the Center, oversaw production, operations, and field research on the UCSC Farm from 1990 through 2010. Jim is an instructor for the Center's Apprenticeship Program and for regional growers, with a particular focus on irrigation, small farm viability, tillage systems, and weed management.

ANN LINDSEY (*Making and Using Compost*)

Ann Lindsey was the Center's Apprenticeship Coordinator from 1995 to 2001 and currently works on program development and fundraising for the Center.

ANDREW MARSHALL (*The Development of U.S. Agriculture*)

Andrew Marshall, PhD, is the Educational Programs Director at Maine Organic Farmers and Gardeners Association. He received his degrees from Bowdoin College and UCSC's Department of Environmental Studies.

ORIN MARTIN (*Garden and Field Tillage and Cultivation; Transplanting and Direct Seeding; Making and Using Compost*)

Orin Martin has run the Alan Chadwick Garden and other teaching gardens at UCSC for more than 35 years, acting as a main instructor for the Center's Apprenticeship course throughout. Orin also teaches undergraduate classes and public workshops, and writes extensively on horticultural topics for the general public.

ALBIE MILES (*Editor, contributor to Part 3, Social and Environmental Issues in Agriculture*)

Albie Miles was the original editor for *Teaching Organic Farming & Gardening: Resources for Instructors*, and is now Assistant Professor of Sustainable Community Food Systems at the University of Hawaii, West Oahu. He received his PhD in Environmental Science, Policy and Management from UC Berkeley.

KATIE MONSEN (*Managing Soil Health; Selecting and Using Cover Crops; Part 2, Applied Soil Science*)

Katie Monsen is a lecturer in Environmental Studies and sustainability studies at UCSC. She earned her PhD at UCSC, studying nitrogen dynamics in organic vegetable production systems on California's Central Coast. Her interests range from food miles to freshwater ecology, with a research focus on legume cover crops.

DIEGO NIETO (*Managing Arthropod Pests*)

Diego Nieto is a Staff Research Associate in UCSC's Environmental Studies Department, and an adjunct faculty member at Cañada College in Redwood City, California. His research focuses on arthropod pest management in organic systems, including farm-scaping/landscaping diversification, and classical and conservation biological control.

DOUG O'BRIEN (*Managing Plant Pathogens*)

Doug O'Brien, PhD (plant pathology), owns and operates Doug O'Brien Agricultural Consulting, providing online technical advice, field monitoring and research for fresh produce growers and shippers in the Monterey Bay Area. He teaches classes in organic agriculture at Cabrillo College, and has worked as an assistant farm advisor and co-owned an organic produce brokerage company.

JAN PEREZ (*Editor of Part 3, Social and Environmental Issues in Agriculture; author of Development of U.S. Agriculture; Social Issues in Current U.S. Agriculture*)

Jan Perez is an Associate Specialist in Social Science Research and Education at the Center. She has been conducting research and evaluation on programs and social issues in the food system at the Center since 2001. She received an M.S. in adult education from the University of Wisconsin, Madison.

KRISTIN REYNOLDS (*Part 3, Social and Environmental Issues in Agriculture*)

Kristin Reynolds, PhD, is an adjunct faculty member at the New School for Public Engagement in New York City and teaches at the Yale School of Forestry and Environmental Studies. Her current research explores urban agriculture, social justice in the food system, and action research.

EDD RUSSELL (*Soil Physical Properties, Soil Chemical Properties*)

Edd Russell was formerly a Soil Scientist for the Natural Resource Conservation Service in Kern County, California, has done extensive agriculture and com-

munity development work in Haiti. He is currently working in Thailand.

BILL SETTLE (*Managing Arthropod Pests*)

Bill Settle, PhD, was the extension entomologist for the Center in 2001–2002 and is currently serving as a Senior Technical Officer for the United Nations Food and Agriculture Organization based in Rome. Bill works extensively in Southeast Asia and Africa as a researcher and trainer for programs related to agroecology and farmer-centered projects.

CAROL SHENNAN (*Managing Soil Health; Selecting and Using Cover Crops*)

Carol Shennan is a Professor of Environmental Studies at UCSC and a past Director of the Center. She teaches classes in sustainable agriculture, participatory research, crop management, and ecology and society. Her current research focuses on organic alternatives to soil fumigation for pest and disease control.

NEIL THAPAR (*Supplements in Part 1: No. 2 in Units 1.1 and 1.2, No. 3 in Unit 1.3, No. 1 in Unit 1.4, 1.6, 1.9, and 1.11, No. 4 in Unit 1.5*)

Neil Thapar is a staff attorney at the Sustainable Economies Law Center, based in Oakland, California, where he researches legal barriers to developing more resilient food systems, leads educational workshops on legal basics for starting urban farms and small food businesses, and advocates for laws that support more just and resilient local food systems.

NANCY VAIL (*Transplanting and Direct Seeding*)

Nancy Vail is co-founder and co-director of Pie Ranch, an educational farm in Pescadero, California. From 1998–2008 she managed the UCSC Farm's community supported agriculture program and taught row crop production, orchard management, and marketing skills.

KEITH WARNER (*Environmental Issues in Modern Agriculture; A Brief History of Resistance to the "Modernization" of Agriculture; Imagining Alternatives*)

Keith Warner is an Associate Adjunct Lecturer at Santa Clara University. He received his PhD from UCSC's Department of Environmental Studies.

MATTHEW WERNER (*Soil Biology and Ecology*)

Matthew Werner, PhD, is the former Soil Ecology Specialist for the Center, whose research focused on sustainable agriculture, soil management in transition to organic, and earthworm ecology. Matthew works as

an inspector for California Certified Organic Farmers, inspecting 50–60 organic farms on California’s Central Coast each year.

GREGG YOUNG (*Reading and Interpreting Soil Test Reports*)

Gregg Young is a Certified Professional Agronomist and has worked as an agronomist and pest control advisor in northern California for more than 40 years. Gregg has taught agriculture, soil science, and pesticide safety classes at Mendocino Community College.

REVIEWERS

Vanessa Bogenholm is a certified Pest Control Advisor and owner/operator of V.B. Agricultural Services, an agricultural consulting business.

Eric Brennan, PhD, is a Research Horticulturist with the USDA’s Agricultural Research Service in Salinas, California.

Mike Buttress is an agronomist for A & L Western Agricultural Laboratories in Modesto, California.

R. Michael Davis is Professor of Plant Pathology and Continuing Education Specialist for the Department of Plant Pathology at UC Davis.

Leonard Diggs is the Farm Manager for the Shone Farm at Santa Rosa Junior College in Santa Rosa, California.

Hellen Englesberg is the Nursery Manager at the Arboretum at UCSC.

Phil Foster is the owner of Phil Foster Ranches in San Juan Bautista, California.

Bill Friedland is Professor Emeritus of Community Studies at UCSC.

Lyn Garling is Program Manager for the Integrated Pest Management Program at Penn State University, and was the Center’s Apprenticeship Coordinator from 1985–1992.

Mark Gaskell, PhD, is a Cooperative Extension Farm Advisor in Santa Barbara County, California.

Gregory Gilbert is a Professor of Environmental Studies at UCSC.

Phil Howard is an Associate Professor in the Department of Community Sustainability at Michigan State University.

Charles F. Krauter is a Professor of Soils and Water at California State University, Fresno.

Wendy Krupnick is an instructor in the Sustainable Agriculture Program at Santa Rosa Junior College in Santa Rosa, California.

Ann Lopez is an emerita Professor of Environmental Science at San Jose City College in San Jose, California and Executive Director of the Center for Farmworker Families.

Joji Muramoto, PhD, is an Associate Researcher in the Environmental Studies Department at UCSC.

Damian Parr, PhD, is the Center’s Research and Education Coordinator, and teaches and advises UCSC undergraduate students.

Sajeemas Pasakdee, PhD, is a Soil Scientist and Agronomist at California State University Fresno.

Bill Settle (see Contributors)

Richard Smith, PhD, is a Farm Advisor, Vegetable Crop Production and Weed Science for UC Cooperative Extension in Monterey, California.

Candace Stafford, PhD, teaches plant pathology at Hartnell College in Salinas, California.

Holly Stein, a 2012 graduate of the Center’s Apprenticeship program, is the Assistant Farm Manager at Cultivating Community’s Fresh Start Farm, an incubator farm for East African Refugees, in Lisbon, Maine.

Neil Thapar (see Contributors)

Mark Van Horn is the Director of the Student Experimental Farm at the University of California, Davis.

Elaine Walker, a 2012 graduate of the Center’s Apprenticeship program, is the owner and operator of Vibrant Valley Farm in McMinnville, Oregon.

Darryl Wong is the Center’s Farm Site and Research Lands Manager, and instructs UCSC undergraduates and students in the Center’s Apprenticeship in organic row crop production.

Note that this list acknowledges Contributors and Reviewers to the first and second editions, as well as the current edition

How to Use This Resource

Teaching Organic Farming and Gardening: Resources for Instructors is a tool intended to increase and improve education in practical organic agriculture and horticulture skills and concepts. While the majority of the manual is devoted to practical training, the instructional materials also cover the science behind the practices, and provide a detailed introduction to social and environmental issues in agriculture. Although much of the material is designed for field or garden demonstrations and skill building, most of the units can also be tailored to a classroom setting. The manual is designed so that units or even individual lectures or demonstrations can be pulled out to be used on their own or in any sequence.

This manual is divided into three sections:

PART 1: ORGANIC FARMING AND GARDENING SKILLS AND PRACTICES

The eleven units in this section emphasize the “how-to” aspects of organic gardening and farming, including propagation, irrigation, tillage, transplanting, and compost production. This section also introduces students to critical skills and considerations in the management of soil fertility and agricultural pests (arthropods, diseases, and weeds) in organic systems. The information included in the manual is based on certified organic production practices that meet or exceed the USDA’s National Organic Program (NOP) standards. Included throughout is an overview of principles and practices used in NOP-certified production.

PART 2: APPLIED SOIL SCIENCE

This three-unit section covers basic information on soil physical properties, soil chemistry, and soil biology and ecology, providing a more detailed overview of the underlying scientific principles that inform many of the organic farming practices covered in Part 1.

PART 3: SOCIAL AND ENVIRONMENTAL ISSUES IN AGRICULTURE

This four-unit section first outlines the history and development of agriculture in the U.S. and then introduces students to social and environmental issues associated with conventional agriculture practices and the current organization of the food system. This section also introduces students to the various forms of

resistance and alternative movement to the dominant systems.

UNIT COMPONENTS

Each unit in this manual contains multiple components, with some components being designed for the instructor, some for students, and some for both. Not all units contain all of the components outlined below, as some units are largely lecture-based (requiring no field demonstrations or hands-on exercises, for example) and others include extensive hands-on components that build on the lectures.

The units are designed with some or all of the following components:

Introduction—*A one- or two-page overview for use by instructor and students*

In the Introduction, the *Unit Overview* provides a summary of the unit, including a description of the information and skills to be conveyed. The *Modes of Instruction* list the suggested lectures, demonstrations, exercises, and assessment questions included in the unit (with an estimated time required for both preparation and implementation). The *Learning Objectives* list the fundamental skills and concepts in each unit that students are expected to learn. The learning objectives serve as the foundation for overall unit content and provide the basis for the evaluation of student comprehension.

Lecture Outlines—*Detailed outlines to guide presentations and/or discussions*

The lectures include pre-assessment questions that may be used to gauge student knowledge at the beginning of the unit. The outlines include the essential qualitative and quantitative information and are intended to provide a broad but comprehensive overview of a subject, identifying many of the key concepts within a given discipline. Instructors are encouraged to adapt the overall content of the lecture to specific audiences or settings. Some units have one lecture outline and some have several. Copies (or online versions) of the lecture notes can be given to the student before the lecture. All technical terminology is either defined in the text or included in the glossary of terms at the end of each unit.

Demonstration Outlines

These instructor outlines provide an overview of the preparations and suggested content for field demonstrations of specific agricultural and horticultural practices. They include time requirements for preparation, materials lists, site preparation instructions, the demonstration sequence, and demonstration lecture outline.

Step-By-Step Sheets—*For student use following Demonstration Outline*

These detailed “how-to” instructions walk students through tasks such as building a compost pile and preparing a planting bed. The sheets include the preparation, sequence, and techniques used in executing a task (parallels the instructor’s Demonstration Outline).

The step-by-step sheets contain sufficient information for students to use them as a reference tool when working independently. They are intended to be provided with the Hands-on Exercises, below.

Hands-On Exercises

These activities or exercises serve to reinforce student comprehension of the subject matter or skill through active participation and practice immediately following a technique-based demonstration.

Assessments Questions (and Answer Key)

Five to ten short essay questions based on the lecture content and demonstration(s) are used to gauge student comprehension of the subject matter presented. Questions are intended to be a balance of theoretical and applied knowledge and require some synthesis of information. Assessments are based on learning objectives.

Discussion Questions

Some units have questions after the lecture. These questions can be used for class discussions to further explore and integrate the information from the lecture.

Suggested Readings

Certain units list specific preparatory readings for the student (see the Unit Overview or the beginning of the References and Resources section).

Resources and Resources Section

This section includes an annotated listing of books, periodicals, websites, films, videos, organizations, and equipment or material suppliers on the subject matter addressed in each unit. References from the lectures are also included here.

Supplements

Narrative supplements provide more detailed information on topics presented in the lectures.

Appendix Section

The appendices provide tables, graphs, charts and/or graphics used as visual aids in lectures, demonstrations, or as student reference materials associated with the Hands-on Exercises.

Glossary

Several units include an alphabetical listing of technical terms used in either the lecture or demonstration.

Online Resources: Videos and Powerpoints

Each of the units in this manual is also available online as a .pdf. Videos and Powerpoints to illustrate a number of the lectures and exercises are also available online. We will continue to add material to the online materials at: casfs.ucsc.edu/about/publications. Look for the Teaching Organic Farming & Gardening link.

Organic Farming and Gardening Skills and Practices

Unit 1.1: Managing Soil Health	3
Unit 1.2: Garden and Field Tillage and Cultivation	31
Unit 1.3: Propagating Crops from Seed, and Greenhouse Management	95
Unit 1.4: Transplanting and Direct Seeding	165
Unit 1.5: Irrigation—Principles and Practices	203
Unit 1.6: Selecting and Using Cover Crops	263
Unit 1.7: Making and Using Compost	295
Unit 1.8: Managing Arthropod Pests	341
Unit 1.9: Managing Plant Pathogens	371
Unit 1.10: Managing Weeds	393
Unit 1.11: Reading and Interpreting Soil Test Reports	429

Managing Soil Health

Introduction	5
Lecture 1: Managing Soil Health— Concepts, Goals, and Components	7
Lecture 2: Managing Soil Health— Sustainable Agriculture Practices	13
Assessment Questions and Key	19
Resources	21
Supplements	
1. A Soil Primer with Sustainable Management Strategies	25
2. The Global Socio-Environmental Effects of Soil Erosion	28

Introduction: Managing Soil Health

UNIT OVERVIEW

“Feed the soil to feed the plant” is a basic principle of organic farming and gardening. This unit introduces students to the ways that farmers and gardeners develop and maintain soil health and fertility in organic farming systems. Two lectures describe the objectives and components of soil health management and the various practices used to develop and maintain healthy, fertile soil. Supplements offer an overview of the soil ecosystem, and address the way that sustainable soil management practices can combat the environmental and social problems created by soil erosion. Note that this unit introduces and integrates a number of topics, including tillage and cultivation, composting, cover cropping, and irrigation, which are addressed in detail in subsequent units.

It should be emphasized throughout the lectures that the overall goal of a soil health management program is to balance nutrient inputs and outputs and ensure a good balance of nutrients for the crop. This balance requires a complex mix of soil management activities including proper tillage, irrigation, crop residue management, weed management, and crop rotation planning. Neglecting any of these components can compromise soil health and quality, affect crop performance, and create potential pollution problems due to erosion, nutrient runoff or leaching.

MODES OF INSTRUCTION

- > LECTURE (2 LECTURES, 3 HOURS TOTAL)
 - Lecture 1 presents the concepts, objectives, and components of sound soil health and fertility management programs for certified organic production systems.
 - Lecture 2 describes the sustainable agriculture practices (e.g., tillage, cover crops, composts, soil amendments) that go into organic soil health and fertility management.
- > ASSESSMENT QUESTIONS (0.5 HOUR)
 - Assessment questions reinforce key unit concepts and skills.

LEARNING OBJECTIVES

CONCEPTS

- Fundamentals of sustainable agriculture
- Soil fertility in organic and sustainable farming systems
- Soil quality
- The relationship amongst soil fertility, plant health, and the resistance and resilience of crop plants to pests and pathogens
- Goals of a sustainable fertility/soil management program
- Components of a soil fertility management program
- The role and impacts of tillage
- The role of cover crops in soil fertility management
- The use of composts, manures, and other organic amendments
- Nutrient budgets as a management tool
- Considerations in the design of crop rotations

Lecture 1: Managing Soil Health—Concepts, Goals, & Components

Pre-Assessment Questions

1. What is organic farming?
2. If you were to implement an organic and sustainable soil fertility management program for a farm or garden, what would be your overarching goals?
3. Then what would the main components of that fertility management program be?
4. How do you define soil quality?
5. How do you define soil fertility for an organic farming system?
6. How is soil quality related to pest management?
7. How is soil quality related to water management?

A. Sustainable and Organic Agriculture Defined

1. “Sustainable agriculture” defined

Sustainable agriculture can be defined as an approach to agriculture where the aim is to create environmentally sound, economically viable, and socially just food and agricultural systems. Emphasis is placed on renewable resources and the management of self-regulating ecological and biological processes and interactions in order to provide acceptable levels of crop, livestock, and human nutrition, protection from pests and diseases, and an appropriate return to the human and other resources employed. Reliance on external inputs, whether chemical or organic, is reduced as far as is practically possible. The objective of long-term sustainability lies at the heart of organic farming and is one of the major factors determining the acceptability of specific production practices. Note, however, that certified organic agriculture also has a specific legal definition (see below).

Sustainable agriculture is not just the conservation of non-renewable resources (soil, energy, and minerals) used to produce food and fiber. Sustainable agriculture also encompasses: The maintenance or restoration of surrounding ecological landscapes; the economic viability for all involved in agricultural production, processing and distribution; and more equitable distribution of agricultural products to assure that basic human needs are met (see Unit 3.4, Sustainable Agriculture and Sustainable Food Systems).

2. “Organic agriculture” defined

a) Organic agriculture has both general and legal definitions. Generally, organic agriculture refers to farming systems that avoid use of synthetic pesticides and fertilizers. In the United States, organic farming is defined by rules established by the U.S. Department of Agriculture’s National Organic Standards Board (NOSB).

- i. “Certified Organic” agriculture as defined by The National Organic Program (NOP; www.ams.usda.gov/nop/)

Organic production: “A production system that is managed in accordance with the Act (The Organic Foods Production Act [OFPA] of 1990, as amended in the NOP) to respond to site-specific conditions by integrating cultural, biological, and mechanical practices that foster cycling of resources, promote ecological balance, and conserve biodiversity.”

Further, it is a system of agriculture that encourages healthy soil and crops through such practices as nutrient and organic matter recycling, crop rotations, proper tillage, and the strict avoidance of synthetic fertilizers and pesticides for at least three years prior to certification

- b) Requirements for organic certification under the National Organic Program
 - i. Organic System Plan: The NOP requires that all crop, wild crop, livestock, and handling operations requiring certification submit an organic system plan to their certifying agent and, where applicable, the State organic program (SOP). The organic system plan is a detailed description of how an operation will achieve, document, and sustain compliance with all applicable provisions in the OFPA/NOP. The certifying agent must concur that the proposed organic system plan fulfills the requirements. The organic system plan is the forum through which the producer or handler and certifying agent collaborate to define, on a site-specific basis, how to achieve and document compliance with the requirements of organic certification. See the USDA's National Organic Program (NOP) website, www.ams.usda.gov/nop/ for additional details of Organic System Plan requirements.

B. Soil Fertility and Soil Health in Sustainable Farming Systems

1. Soil health and fertility defined (see www.nrcs.usda.gov/wps/portal/nrcs/main/soils/health/, and soilhealth.cals.cornell.edu/)
 - a) "Soil health" and "soil quality" can be used interchangeably. They are: The capacity of a soil to function, within land use and ecosystem boundaries, to sustain biological productivity, maintain environmental quality, and promote plant, animal, and human health (Doran and Parkin 1994).
 - b) Soil fertility is a feature of soil health as applied to agroecosystems. It is the capacity of a soil to provide nutrients required by plants for growth.
 - c) Soil health is established through the interactions of soil's physical, chemical, and biological, properties (see more at Supplement 1, A Soil Primer with Sustainable Management Strategies, and Part 2, Applied Soil Science)
 - i. Physical properties include soil texture, a physical measurement of the percent of sand, silt, and clay; and soil structure, the arrangement of individual soil particles (sand, silt, clay) into aggregates or "clumps"
 - ii. Chemical properties of a soil measure its nutrient-carrying capacity and pH (acidity)
 - iii. Biological properties refer to the community of soil organisms (principally bacteria, fungi, and actinomycetes)
 - d) Soil health indicators (see soilhealth.cals.cornell.edu/)
 - i. Soil provides adequate levels of macro- and micronutrients to plants and soil microbes. This reflects the ability of the soil to mineralize nutrients and a moderate pH (~6.0–7.0) that allows the nutrients to be both held in the soil and available to plants as needed.
 - ii. Soil has good "tilth." This includes a good structure that resists degradation (e.g., erosion and compaction), provides adequate aeration and rapid water infiltration, and accepts, holds, and releases water to plants and groundwater.
 - iii. Soil promotes good root growth and maintains good biotic habitat that sustains high and diverse populations of beneficial organisms and low populations of pests and pathogens
 - iv. Soil has low salinity levels and low levels of potentially toxic elements (e.g., boron, manganese, and aluminum)
 - v. Soil has high resilience and is able to withstand deleterious events, such as drought and flooding
2. Soil fertility, plant health, and the resistance and resilience of crop plants to pest and pathogens
 - a) Soil fertility requires a balance of critical plant nutrients. Either a deficiency or an excess of nutrients can adversely affect plant growth, susceptibility to pests and pathogens, and post-harvest quality.

C. Goals of a Sustainable Soil Fertility Management Program

1. To sustain high crop productivity and crop quality in food and fiber production (not maximum yields, which typically require excessive nutrient inputs to achieve)
 - a) Crop productivity, crop quality, and the economic viability of a given farming operation
2. To minimize environmental quality and human health risks associated with agricultural production
 - a) Important steps in minimizing human health risks and on- and off-farm impacts
 - i. Avoid the use of all synthetically compounded materials (e.g., fertilizers and pest control agents, etc.) known to have an associated environmental quality or human health risk
 - ii. Avoid creating non-point source (NPS) pollution through surface runoff and leaching. Excess nutrients (especially nitrogen and phosphorus) can degrade the quality of groundwater, surface freshwater (e.g., rivers, lakes and wetlands), and nearshore marine environments, causing eutrophication (low oxygen levels) and allowing weedy species to outcompete native species as well as polluting drinking water (see Supplement 5, Nitrate Contamination of Groundwater, in Unit 1.5, Irrigation—Principles and Practices) among other negative effects.
 - iii. Prevent soil erosion and sedimentation of waterways. Soil loss reduces production capacity and soil entering waterways may degrade aquatic habitat (see more at Supplement 2, The Global Socio-Environmental Effects of Soil Erosion).
 - iv. Close nutrient cycles as much as possible within the field and farm to reduce energy use and environmental impact of food and fiber production
 - v. Close nutrient cycles at multiple scales (e.g., watershed, regional, and national scales)
3. To assess and maintain soil health for long-term functioning of the above goals

D. Components of a Sustainable Soil Fertility Management Program: The Means to Achieving the Above Goals

1. Improving and maintaining physical, chemical, and biological properties of soil involves a suite of interrelated practices. Because these properties are so deeply and complexly interconnected, soil health management requires an overall approach focused on how the soil and plants are managed, rather than a product-based approach that focuses primarily on delivering chemical “solutions” to nutrient and pest “problems.”
 - a) Sustainable agricultural practices used to improve and sustain soil physical and biological properties
 - i. Maintain or increase soil organic matter (SOM) levels through inputs of compost and cover cropping (see Unit 1.6, Selecting and Using Cover Crops and Unit 1.7, Making and Using Compost). SOM has a high capacity to hold and release inorganic nitrogen and other essential nutrients to plants. Organic matter inputs enhance the stability of soil aggregates, increase the porosity and permeability to water and air, and improve the water-holding capacity of soils. The primary constituents of SOM are organic compounds rich in carbon. Building or maintaining the level of soil carbon provides the energy and nutrients necessary to stimulate the soil microorganisms responsible for decomposition and the formation of soil aggregates and more desirable soil structure. See also: www.nature.com/scitable/knowledge/library/soil-carbon-storage-84223790.
 - ii. Provide a balanced nutrient supply for the crop, also through compost and cover cropping. Use in-season supplemental fertilizers (when suggested as necessary by soil test results, plant growth observations, or plant tissue testing) to prevent or address plant nutrient deficiencies. See the Cornell Soil Health Assessment Training Manual for examples: soilhealth.cals.cornell.edu/.

- iii. Time tillage properly to stimulate the decomposition of SOM by breaking up compacted areas and large soil clods and thus increase aeration (O₂ supply to aerobic microbes) and expose a greater surface area for microbial breakdown. Appropriately timed tillage also increases water infiltration and good drainage (see Unit 1.2, Garden and Field Tillage and Cultivation).
 - iv. Manage irrigation carefully to avoid runoff, erosion, and leaching of soluble nutrients. For irrigation-dependent crops, manage soil moisture between 50% and 100% of field capacity through soil moisture monitoring and moisture retention techniques such as mulching (see Unit 1.5).
 - v. Manage crop rotations and crop sequences carefully to build SOM and to alternate rooting depths and nutrient demands of crops, where possible making use of different parts of the soil profile over time
2. Improve and maintain chemical properties of soil (see also Unit 2.2, Soil Chemistry and Fertility)
- a) Benchmarks of optimal soil chemistry
 - i. Balanced levels of available plant nutrients (see Unit 1.11, Reading and Interpreting Soil Test Reports, for more on this subject)
 - ii. Soil pH ~6.0–7.0: At this soil pH the greatest amount of soil nutrients are available to crops
 - iii. Low salinity levels: The accumulation of salts in the soil may result in plant water and salt stress
 - b) Sustainable agricultural practices used to develop and maintain optimal soil chemical properties
 - i. Provide a balanced nutrient supply for the crop. As plant growth is related to the availability of the most limiting nutrient, it is essential to consider the balance (ratios) of soil nutrients available. Yield and quality may be limited if levels of some nutrients are too high while others are too low.
 - ii. Conduct soil analysis with periodic monitoring. Soil analysis provides current quantitative information on the nutrient profile of a given soil. Soil analysis report data should be compared to established optimal benchmarks of soil fertility when developing soil amendment plans to assure adequate but not excessive nutrient applications. Comparing results from multiple years of sampling will show whether you are depleting or accumulating soil nutrients over time, and indicate whether changes in fertility management are needed.
 - iii. Conduct plant tissue testing. In-season plant tissue testing provides current quantitative data on the nutrient profile of growing plants. Such data may be compared with recommended nutrient levels and may be used to determine the need for mid-season supplemental fertilizing (see Resources section). However, be aware that most tissue testing information has been developed for systems using synthetic chemical fertilizers, and sufficiency levels may well differ for organic systems.
 - iv. Time seasonal nutrient release from organic amendments to correspond with crop requirements. Example: Along the Central Coast of California, crops are planted approximately 2–3 weeks after the incorporation of cover crops in late March–early April in order to synchronize the nitrogen demand of cash crops with the nitrogen liberated from cover crop decomposition. Important factors influencing the mineralization rate include:
 - The quality of the organic matter input: E.g., carbon:nitrogen ratio, lignins, tannins, polyphenols, etc.
 - Environmental factors such as soil temperature and moisture

- Note: When nitrogen from cover crops is mineralized in excess of crop demand, nitrate will be vulnerable to leaching
 - v. Generally keep fields covered with a crop, cover crop, or mulch. Avoid leaving fields bare to avoid wind and water erosion and nutrient leaching.
 - vi. Manage irrigation carefully to avoid runoff, erosion, and leaching of soluble nutrients
 - vii. Supply major nutrients primarily through organic matter and mineral soil amendments (e.g., cover crops, composts, limestone, rock phosphate, etc.)
 - viii. Allow sufficient time for fresh residue to break down before planting crops
 - ix. Use in-season supplemental fertilizers (when suggested as necessary by soil test results, plant growth observations, or plant tissue testing) to prevent or address plant nutrient deficiencies
3. Increasing soil health can also help minimize susceptibility to diseases and pests. Some practices in organic agroecosystem management are particularly helpful towards this end.
- a) Maintain soil nutrient levels and soil pH within optimal range to reduce plant nutrient deficiencies or excesses. Plant nutrient deficiencies or excesses often lead to increased susceptibility to pests and pathogens.
 - b) Build and maintain soil organic matter to promote desirable soil physical properties and supply essential plant nutrients. For example, adequate drainage discourages prolonged wet conditions that can lead to root rot, damping off, and other soil-borne diseases. Soil with high SOM can also provide habitat for beneficial soil microbes that may impart disease-suppressive qualities to agricultural soils.
 - c) Planting a high diversity of crops can increase the diversity of soil microbe populations by supplying the microbes with diverse food sources and other compounds, such as chemoattractants, from crop residue and root exudates. High microbial diversity can help suppress pests and diseases.
 - d) Design appropriate rotations to break pest cycles, and include disease-suppressive crops or cover crops. Changing the place in the garden or field where crops are grown interrupts the host/pest cycle and thereby reduces or limits the development of populations of pest and pathogens.
 - e) Maintain soil moisture within optimal ranges for plant growth and the avoidance of compaction and erosion
 - f) Use appropriate preventive (e.g., farmscaping) and active biocontrol practices to suppress the growth of pest populations (see Unit 1.8, Managing Arthropod Pests)
4. Summary

The sustainable farming practices described above, including crop rotations, soil amending and fertilizing, tillage, and irrigation techniques, should be used in concert to improve and maintain the quality and health of agricultural soils. Soil quality in turn affects crop performance (yield) and the resistance and resilience of crop plants to pests and pathogens.

Lecture 2: Soil Fertility Management—Sustainable Agriculture Practices

A. Main Goals of Managing for Soil Health

1. One of the key concepts of Lecture 1 was that soil fertility is a feature of soil health as applied to agroecosystems. It is the capacity of a soil to provide nutrients that plants require for growth.
2. Key indicators of soil health include
 - a) The ability of the soil ecosystem to mineralize nutrients and make them available to plants
 - b) A moderate pH, which promotes nutrient retention and makes nutrients available to plants
 - c) Good structure, or tilth, that resists degradation and provides adequate air and water to roots
 - d) Good biotic habitat, particularly for beneficial organisms
3. One of the main ways to support these goals is by increasing the carbon content of the soil in the form of soil organic matter (SOM)
 - a) SOM has three main constituents. As summarized by Cornell University Cooperative Extension, these are:
 - i. Plant debris and living microbial biomass
 - ii. Detritus (active soil organic matter, made of partially decomposed plant, animal, and microbial tissues)
 - iii. Humus (stable soil organic matter)
 - b) The microbes help decompose the plant debris and the detritus, while humus (a black, sticky substance) is the final product of decomposition
 - c) SOM has many benefits for the soil, supporting the key indicators of soil health listed above. Some of these functions include those below (and see the Cornell University Cooperative Extension Fact Sheet 41 [franklin.cce.cornell.edu/resources/soil-organic-matter-fact-sheet] for more functions and details):
 - i. It provides the source of substances for mineralization
 - ii. SOM, especially the humus fraction, helps maintain soil pH biochemically
 - iii. It helps soils resist crusting and decreases erosiveness
 - iv. Plant debris and detritus fractions of SOM provide food for the microbial biomass
4. All these benefits of SOM make it “money in the bank” for the agroecosystem. Maintaining and increasing SOM are the basis of the soil health practices described in this lecture.

B. Soil Cultivation in Sustainable Agriculture (see also Unit 1.2, Garden and Field Tillage and Cultivation)

1. Cultivation is physically working the soil for seedbed preparation or weed control, using hand tools or mechanical implements. It is synonymous with tillage.
2. Services provided by tillage
 - a) Prepares soil for seeds or transplants by improving soil aeration and breaking up soil clods
 - b) Incorporates crop or cover crop residue, helping make carbon and macronutrients, especially nitrogen, available to soil microbes

- c) Enables the incorporation of amendments such as compost and lime
 - d) Allows soil to dry more rapidly
 - e) Allows soil to warm up more rapidly
 - f) Increases microbial activity and mineralization rates in the short-term
 - g) Deep tillage can break through compacted layers that are a barrier to root growth and water movement
 - h) Controls weeds by burial or exposure of seeds or seedlings (see Unit 1.10, Managing Weeds)
 - i) Controls overwintering insects by exposure to the surface
3. Disadvantages of tillage
- a) May accelerate the rate and extent of long-term declines in soil organic matter
 - b) May increase sub-soil compaction problems and impede drainage and root growth
 - c) Has high energy and labor costs
 - d) Loss of soil organic matter (SOM) from excessive tillage can lead to crusting of bare soils, impeding seedling emergence and water infiltration
4. Advantages of conservation tillage systems
- a) Residue cover on the soil surface protects the soil from wind and water erosion
 - b) Increases moisture retention
 - c) Increases SOM over time (years), reaching a higher “steady state” than tilled systems in the same environment
5. Limitations of conservation tillage systems
- a) Residue cover lowers soil temperature, which delays seed germination and slows seedling growth and may place grower at an economic disadvantage
 - b) Weed control is very difficult without use of herbicides
 - c) Conservation tillage requires specialized equipment such as no-till drills for seeding
 - d) Increased leaching of nutrients and herbicides into the groundwater has been shown in some systems after years of reduced or no-till agriculture
6. Conservation tillage practices can also be employed on a small scale
- a) For example, laying down a base of cardboard followed by a layer of wood chips can be effective at reducing weed pressure while increasing SOM with relatively little work (see Unit 1.10)

C. Cover Crops in Sustainable Agriculture (see also Unit 1.6, Selecting and Using Cover Crops)

1. Services provided by cover crops
- a) Cover crops increase nutrient availability
 - i. Rhizobium bacteria, in association with legume cover crops, are able to convert freely available atmospheric nitrogen (N_2) to a plant usable form (NH_3). The legumes absorb the NH_3 and use it for growth and reproduction.
 - ii. Grass/cereal cover crops, when used alone or with N-fixing legume cover crops, may reduce nutrient losses by capturing mobile nutrients (e.g., NO_3^-) that would otherwise be vulnerable to leaching or to loss through soil erosion
 - iii. After cover crops are mown and incorporated at the end of the season, the residues from both the N-fixing and N-capturing plants are broken down by soil organisms, releasing the cover crop nutrients into the soil solution for plant use

- iv. As a source of labile carbon, cover crops can stimulate microbial activity and increase the breakdown of existing SOM. Cover crops are a source of labile carbon (C) in the soil ecosystem, and as such have a range of potential effects. Plant-derived labile C can affect mineralization of SOM (called a “priming effect”), which can release atmospheric CO₂ from the SOM and allow mineralization of N from the SOM, making stored nutrients available to plants. However, how much this happens depends on the specific soil and other interacting factors.
 - v. Deep-rooted cover crops are able to recycle nutrients acquired from deeper in the soil profile (e.g., phosphorus), acting essentially as nutrient “pumps”
 - b) Cover crops improve soil physical properties: Carbon and nutrient cycling through the use of cover crops result in short-term improvements to soil physical properties
2. Influences on nutrient release from cover crops
- a) Decomposition of cover crops in the soil begins with primary consumers that consume the cover crop residue. These include large invertebrates such as earthworms, millipedes, sowbugs, and slugs. As the large organisms consume the plant materials, they shred it, creating greater surface area for microscopic invertebrates, such as nematodes, and microbes such as bacteria and fungi to continue the decomposition process.
 - b) Temperature and moisture conditions affect the level of microbial activity (lower bioactivity at cooler temperatures, and under dry or waterlogged conditions)
 - c) Location of the residue: Residue may be left on the soil surface (as in conservation tillage) or incorporated into the soil
 - i. Incorporation into the top 6–8 inches of the soil: With adequate moisture, will decompose most rapidly due to high oxygen levels and large populations of decomposing organisms
 - ii. Leaving cover crop residue on soil surface: Will decompose more slowly due to drying. However, in some systems and under certain conditions (especially warm temperatures and adequate moisture), soil organisms may move surface residue below ground, facilitating decomposition.
 - iii. Below 6–8 inches: May decompose more slowly due to lower oxygen levels and fewer decomposing organisms
 - d) Composition of the cover crop residue
 - i. The carbon to nitrogen (C:N) ratio of the cover crop residue has a close link with N mineralization. Higher cereal biomass produces higher C:N, while more legume-heavy biomass produces lower C:N. Microbes need both C and N, the C in carbohydrates to combust for energy and the N for building amino acids necessary for maintenance and reproduction. The relative amount of C and N available for microbes determines how large the pool of mineralized nitrate in the soil will be.
 - C:N ratios of 22:1 or less result in net mineralization of N. Nitrate is liberated into soil solution and is thus available for plant uptake or leaching.
 - C:N ratios above 22:1 result in net immobilization of N. Nitrogen is bound in organic forms and is unavailable for plant uptake. Nutrient deficiencies may result if this state is prolonged.
 - Because the C:N ratio of cover crops increases as they age, it is generally recommended that cover crops be harvested or incorporated into the soil when close to full bloom (but prior to seed set) to assure a C:N ratio of 22:1 or less so that net mineralization occurs
 - ii. The presence of lignins and tannins in cover crop residue slows the rate of decomposition. Lignins and tannins are organic compounds that are produced by plants and have high C:N.

3. The timing of nutrient release, crop demand, and the fate of essential plant nutrients
 - a) Growers generally should try to manage the timing of nutrient release from cover crops to coincide with crop demand (see D. 2. in Lecture 1)
 - b) Nutrients (particularly N in the form of nitrate) can become vulnerable to loss if timing is mismatched
 - c) If timing is mismatched, nutrient deficiencies (especially N) may result during key stages in the growth cycle, leading to reduced yields. This is especially true with longer-season crops, e.g., peppers and tomatoes.

D. Composts and Animal Manures in Sustainable Agriculture Fertility (see also Supplement 1, A Soil Primer with Sustainable Management Strategies and Unit 1.7, Making and Using Compost)

1. Both compost and animal manure are sources of organic matter for the soil ecosystem and provide benefits for soil, including:
 - a) Nutrients for crops
 - b) Increased soil organic matter content
 - c) Increased soil cation exchange capacity (CEC)
 - d) Habitat and food for beneficial soil microbes
 - e) Increased soil aggregates
2. Compost application
 - a) Common annual application rates: ~4–5 tons/acre/year on field scale; 10–12 tons/acre/year on garden scale (cropping dependent)
 - b) The nutrient contribution (N:P:K) of compost varies greatly, depending on the raw materials of the compost, and how long and under what conditions it matured. Check with the supplier or have a compost nutrient assessment done to determine nutrient levels and proportions.
 - c) Compost C:N: Compost with C:N of less than 20:1 can provide N to the following crop, but compost with C:N greater than 20:1 can immobilize the N, making it less available to the crop. This depends greatly on the raw materials, as well as the compost's maturity. Here, too, check with the supplier or have a compost nutrient assessment done.
 - d) Application timing: Ideally, nutrient release should coincide with crop demand. However, this is difficult to control in organic systems because it is a biologically-driven process, dependent on microbes breaking down the organic matter.
 - i. Compost is generally applied at the start of the season or when planting new crops during the growing season
 - ii. Compost may be applied midseason as a sidedress (applied adjacent to or between rows of growing crops), although it needs to be incorporated into the soil surface
 - iii. Depending on the quality of the compost, particularly the C:N, it may be an inefficient source of N in the short term
 - iv. Release of N may last 6 weeks to several months following incorporation, depending on the C:N, soil characteristics, and environmental conditions (e.g., weather). Up to 10–15% of the compost N is released the first year.
3. Other considerations of compost use
 - a) Requirements for on-farm compost production (see Supplement 2, Field-Scale Compost Production: A Case Study in Unit 1.7). The feasibility of making compost on the farm (versus “buying in” compost from a commercial source) depends on the farm or garden scale and the overall labor and economics of the operation.
 - i. Labor and knowledge: On-farm compost production requires labor inputs and knowledge of compost production techniques to both build and monitor compost piles

- ii. Equipment and water: On-farm compost production requires proper equipment for pile building and turning, and a water source
 - iii. National Organic Program (NOP) standards for on-farm compost production: The NOP has strict standards for compost production and use, e.g., the number of days the compost is maintained at a particular temperature during the initial composting process. Consult with your certification agency or see the NOP website.
- b) Requirements for off-farm compost purchasing
- i. Local/regional availability
 - ii. Variability in quality
 - iii. Price
 - iv. Shipping or delivery costs
 - v. Storage, if purchased in large quantities
2. Manure application
- a) Composted vs. uncomposted manure: While composted manure provides the benefits of compost as described above, fresh or uncomposted manure may present several problems:
- i. High ammonium levels may result in nitrogen “burns” on plants
 - ii. High ammonium and/or nitrate levels may cause rapid population growth of soil microbes and the subsequent immobilization of N
 - iii. Undigested seeds from the animals’ feed (e.g., hay) or pasture may introduce weeds
 - iv. N is easily leached if stored manure is exposed to rain or if manure is incorporated into the soil shortly before significant precipitation (enough to move the available nitrate and ammonium below the root zone). This contributes to water pollution as well as reduces the amount of N that would be available to plants later.
 - v. Pathogens such as *E. coli* and other disease-causing organisms may be present in fresh manure. The National Organic Program includes guidelines on fresh manure use to prevent contamination of food.
 - vi. Composting the manure also helps address these problems
- b) Restrictions on the use of manure are included in the National Organic Standards of 2002 (see Resources reference on National Organic Program)
- c) The nutrient contribution (N:P:K) of fresh manures varies. See the *Rodale Book of Composting* in the Resources section for more information.

E. Soil Amendments and Supplemental Fertilizers in Sustainable Agriculture

1. Soil fertility management and nutrient budgets: In sustainable agriculture systems, the goal often is to balance nutrient inputs with nutrient outputs each year. A nutrient budget takes into account nutrient inputs, including those from compost and cover crops, and those nutrients lost to crop production and other activities.
- a) Goal: Balance inputs and outputs once you have achieved desired/optimal nutrient levels and ratios
- b) Inputs > outputs = accumulation. Potential risk of excess nutrients leading to non-point source pollution through leaching and runoff (see Supplement 5, Nitrate Contamination of Groundwater, in Unit 1.5, Irrigation—Principles and Practices). As described earlier, it also can increase disease and pest problems.
- c) Inputs < outputs = soil depletion. Potential risk of plant nutrient deficiencies and stress, reduced yield, and increased susceptibility to pests and pathogens.
- d) Example of inputs factored into budget for nitrogen
- i. Inputs = N imported in fertilizers and amendments (including compost and manure) + N fixation through cover crops

- ii. Outputs = N exported in crop harvest + N lost through leaching, erosion, and denitrification
 - iii. Calculating N budgets: See Demonstration 2, Nitrogen Budgeting in Unit 1.11, Reading and Interpreting Soil Test Reports
2. Organic amendments
 - a) OMRI/NOP-certified materials in certified organic farming systems (see the Organic Materials Review Institute website, www.omri.org)
 3. Supplemental fertilizers
 - a) Supplemental fertilizers are used to prevent or remedy acute soil or plant nutrient deficiencies identified through soil analysis reports, plant tissue testing, and/or plant growth observations
 4. Application of nutrient budgets in assessing the health of larger-scale units, such as watersheds and regions
 - a) Example of accumulation and depletion: Confinement animal production facilities import nutrients as feed from large areas, and concentrate waste disposal in small areas

F. Crop Rotation and Crop Sequencing in Sustainable Agriculture (see also *Crop Rotations on Organic Farms: A Planning Manual*, by Charles L. Mohler and Sue Ellen Johnson in Resources)

1. Crop rotations
 - a) Crop rotation defined: The movement of crops from site to site on the farm in a planned sequence
 - b) Rationale behind crop rotation: It interrupts pest-host cycles and prevents the buildup of pests, weeds, and pathogens. Rotation also allows crops to access nutrients from different soil depths, based on their rooting characteristics. Integrating cover crops and fallow periods into rotations helps build soil organic matter and improve aggregation.
2. Rotation and sequencing considerations
 - a) Try to avoid repeated planting of crop species that are subject to similar pests, diseases, and weed pressures in the same beds. Rotate with different crops to remove hosts and break pest cycles.
 - i. Example: Solanaceae rotation. It is common practice to change the location of Solanaceae family crops each year. Because these crops (tomatoes, eggplants, peppers, potatoes, etc.) share common pests and pathogens, repeated cropping in the same location can lead to the buildup of pest populations.
 - b) Rotate crops to maximize use of nutrient inputs and distribute nutrient demand placed on the soil
 - i. Examples of multi-year crop rotations (see Mohler and Johnson 2009 and Coleman 1995 in Resources)
 - c) Rotate crops with various types of root systems to improve soil health and structure. E.g., tap-rooted crops promote water infiltration; fibrous-rooted crops help maintain soil organic matter levels.
 - d) Incorporate fallow periods and perennial cover crop rotations. Fallow periods—areas intentionally left uncultivated and planted to perennial cover crops—allow the soil to remain undisturbed and the aggregation processes to proceed uninterrupted. This can help restore the desired physical components of soil health. See more at Supplement 1, Strategies for Improved Weed Management on Small-Scale, Diverse Farms in Unit 1.10.
3. Crop rotations and within-season sequences are farm specific and will depend on the diversity of crops being grown, as well as factors such as farm location, soil types, climate, and economic factors. See examples at Mohler and Johnson 2009 in Resources.

Assessment Questions

- 1) What is certified organic agriculture?
- 2) Describe the goals of a sustainable soil health management program.
- 3) Define soil fertility/health.
- 4) Describe the relationship amongst soil fertility, plant health, and the resistance and resilience of crop plants to pest and pathogens.
- 5) What are the major components of a sound soil health management program? How does each component function to maintain soil fertility and quality?

Assessment Questions Key

1) What is certified organic agriculture?

- *A certified organic production system is a farming system managed in accordance with The Organic Foods Production Act and the National Organic Standards of 2002. The production system is to be designed and managed to respond to site-specific conditions by integrating cultural, biological, and mechanical practices that foster cycling of resources, promote ecological balance, and conserve biodiversity. Further, it is a system of agriculture that encourages healthy soil and crops through such practices as nutrient and organic matter recycling, crop rotations, proper tillage, and the strict avoidance of synthetic fertilizers and pesticides for at least three years prior to certification. Certified organic farming operations are required to develop and submit an “organic system plan” to their certifying agency detailing how an operation will achieve, document, and sustain compliance with all applicable provisions in the OFPA/NOP. The certifying agent must concur that the organic system plan and ongoing management practices fulfill the NOP requirements.*

2) Describe the goals of a sustainable soil health management program.

- *To sustain high crop productivity and crop quality in food and fiber production*
- *To minimize environmental quality and human health risks associated with agricultural production*

3) Define soil fertility/health.

- *The capacity of a soil to provide nutrients required by plants for growth. This capacity to provide nutrients to crop plants is in part influenced by the physical properties of soils and is one component of soil fertility. Desirable soil physical properties and the capacity of the soil to provide nutrients for growing crops are both soil quality indicators.*

4) Describe the relationship amongst soil fertility, plant health, and the resistance and resilience of crop plants to pest and pathogens.

- *Crops grown in fertile soils are higher quality, better yielding, and are more resistant and resilient to pests and pathogens*

5) What are the major components of a sound soil health management program? How does each component function to maintain soil fertility and quality?

1. *Improve and maintain physical and biological properties of soil*
 - *Organic matter inputs: Compost and cover crops*
 - *Fallow periods*
 - *Properly timed irrigation and tillage*
 - *Soil testing and proper soil amending*
2. *Improve and maintain chemical properties of soil*
 - *Organic matter inputs: Compost and cover crops*
 - *Soil testing and proper soil amending*
 - *Supplemental fertilizing when necessary*
 - *Avoid leaving soils exposed*
 - *Proper irrigation to avoid leaching of nutrients*
3. *Minimize disease/pest susceptibility*
 - *Design appropriate crop rotations and fallow periods*
 - *Polycultures/non-monoculture production*
 - *Use appropriate preventive and active biocontrol practices*
 - *Provide optimal level and balance of nutrients for good plant healths*

Resources

Note: Additional resources related to soil health management are listed in Units 1.2, Garden and Field Tillage and Cultivation; 1.6, Selecting and Using Cover Crops; 1.7, Making and Using Compost; and 1.11, Reading and Interpreting Soil Test Reports

PRINT RESOURCES

Brady, Nyle C., and Ray R. Weil. 2008. *The Nature and Properties of Soil, 14th Edition*. Upper Saddle River, NJ: Prentice Hall.

Comprehensive (965 pages) textbook on soils—great for those who want to “go deeper” into the origins, classifications, and workings of soil.

Chaney, David E, Lori E. Drinkwater, and Stuart Pettygrove. 1992. *Organic Soil Amendments and Fertilizers*. Publication 21505, UC Sustainable Agriculture Research and Education Program. Oakland, CA: University of California Division of Agriculture and Natural Resources.

A concise overview of the materials commonly used in certified organic farming systems to improve and maintain soil fertility. Addresses the role of soil organic matter in farming systems and how to evaluate organic materials for on-farm use. Briefly profiles each of the types of organic amendments and fertilizers commonly available.

Clark, Andy (ed.). 2007. *Managing Cover Crops Profitably, 3rd edition*. Sustainable Agriculture Research and Education (SARE) program, Handbook Series Book 9.

Explores how and why cover crops work, and provides all the information needed to build cover crops into any farming operation. Includes information on the characteristics, costs, seeding rates, and management of different cover crop species. Available from www.sare.org as hard copy and free download.

Colemann, Eliot. 1995. *The New Organic Grower: A Master's Manual of Tools and Techniques for the Home and Market Gardener, 2nd edition*. White River Junction, VT: Chelsea Green Publishing Co.

An overview of intensive organic production methods on a small scale. Good section on crop rotation planning.

Fortier, Jean-Martin. 2014. *The Market Gardener: A Successful Grower's Handbook for Small-Scale Organic Farming*. Gabriola Island, BC: New Society Publishers.

Includes a section on organic soil fertility management, with a focus on small-scale, diverse systems. Discusses soil tests, crop requirements, and the use of compost, cover crops, and crop rotations in organic vegetable production to maintain and improve soil health.

Gaskell, Mark, Jeff Mitchell, Richard Smith, Steven Koike, and Calvin Fouche. 2000. *Soil Fertility Management for Organic Crops*. Publication 7249. Oakland, CA: University of California, Division of Agriculture and Natural Resources. anrcatalog.ucdavis.edu/pdf/7249.pdf

A five-page overview of soil fertility for organic production systems

Gugino, Beth K., Omolulu J. Idowu, Robert R. Schindelbeck et al. 2009. *Cornell Soil Health Assessment Training Manual, Edition 2.0*. Geneva, NY: Cornell University, College of Agriculture and Life Sciences. soilhealth.cals.cornell.edu/extension/manual/manual.pdf

Well-written and easy to understand manual addresses soil health, in-field assessment, soil testing, soil health indicators, and sustainable management strategies to maintain and improve soil health.

Hinman, Tammy, Andy Pressman, and Hannah Sharp. 2012. *Resource Guide to Organic and Sustainable Vegetable Production*. ATTRA, National Center for Appropriate Technology (NCAT), IP188.

Includes an extensive listing of publications and websites related to organic and sustainable vegetable production. Available at www.attra.ncat.org

Magdoff, Fred, and Harold Van Es. 2009. *Building Soils for Better Crops, 3rd Edition*. Handbook Series Book 10, Sustainable Agriculture Research and Education (SARE) Program.

An overview of the ecological management of soil fertility covering the basics of soil organic matter, physical, and chemical properties of soil, ecological soil and crop management. Provides

step-by-step information on soil-improving practices as well as in-depth background—from what soil is to the importance of organic matter. Includes case studies of farmers from across the U.S. Practical and accessible information. Available from www.sare.org as hard copy or free download.

Magdoff, Fred, and Ray R. Weil. 2004. *Soil Organic Matter in Sustainable Agriculture*. Boca Raton, FL: CRC Press, Taylor and Francis Group.

This textbook contains evaluations of the types of organic soil constituents—organisms, fresh residues, and well-decomposed substances. It explores the beneficial effects of organic matter on soil and the various practices that enhance soil organic matter (SOM). Examines the impacts of crop management practices on soil organisms, organic matter gains and losses, the significance of various SOM fractions, and the contributions of fungi and earthworms to soil quality and crop growth.

Martin, Orin. 2007. *Soil Cultivation: Fundamental Concepts and Goals*. For the Gardener series. UC Santa Cruz: Center for Agroecology & Sustainable Food Systems. casfs.ucsf.edu/documents/for-the-gardener/soil_cultivation.pdf

Describes the basic concepts associated with soil cultivation and garden bed preparation, including organic matter incorporation, nutrient release, and promoting good tilth and structure.

Michigan State University Extension. 1998. *Michigan Field Crop Ecology*. Extension Bulletin E-2646.

A well-illustrated 85-page publication covering the soil ecosystem processes managed in agricultural systems (e.g., major nutrient cycles, soil biology, pest and disease management). Available from bookstore.msue.msu.edu/.

Mohler, Charles L., and Sue Ellen Johnson (eds.). 2009. *Crop Rotations on Organic Farms: A Planning Manual*. Ithaca, NY: NRAES-177.

Offers an in-depth review of crop rotation and its many applications, such as improving soil quality and health, and managing pests, diseases, and weeds. The authors consulted with expert organic farmers to develop crop rotation and crop sequencing guidelines and

strategies that can be applied under various field conditions and with a wide range of crops. Includes instructions for making crop rotation planning maps using Microsoft Excel and discusses intercropping and crop rotation during the transition to organic farming. Note: Single download and printing for personal use permitted.

Smillie, Joe, and Grace Gershuny. 1999. *The Soul of Soil: A Soil-Building Guide for Master Gardeners and Farmers, 4th Edition*. White River Junction, VT: Chelsea Green Publishing.

Provides essential information on soil ecosystem management for organic growers. Topics include organic matter management, building and maintaining humus, on-site composting, green manures and crop rotations, cultivation and weed control, nutrient balances and soil testing, and using mineral fertilizers.

Tugel, Arlene J., Ann M. Lewandowski, and Deb Happe-vonArb, (eds). 2000. *Soil Biology Primer*. Ankeny, IA: Soil and Water Conservation Society.

An introduction to the living component of soil and how that component contributes to agricultural productivity and to air and water quality. The Primer includes information describing the soil food web and how the food web relates to soil health.

Van Horn, Mark. 1995. *Compost Production and Utilization: A Growers Guide*. Publication 21514. Oakland, CA: University of California Division of Agriculture and Natural Resources.

A short publication focusing exclusively on on-farm composting for growers. Includes sample calculations for achieving optimal C:N ratios, suggestions on compost management, nutrient profiles, and nutrient release patterns of composts.

WEB-BASED RESOURCES

Alternative Farming Systems Information Center, USDA

www.nal.usda.gov/afsic/

Technical information on organic farming, sustainable agriculture, community supported agriculture. Access to National Agricultural Library to research journal article abstracts and order articles.

Appropriate Technology Transfer for Rural Areas (ATTRA)

www.attra.org

A national sustainable farming information center. Information on sustainable farming production practices, alternative crop and livestock enterprises, innovative marketing.

Organic Farming Compliance Handbook: A Resource Guide for Western Regional Agricultural Professionals

www.sarep.ucdavis.edu/sfr/organic/ofch

Developed to help agricultural professionals in the Western U.S. understand effective practices, materials, and processes that comply with organic standards; access expertise and informational resources on organic farming, and answer questions from their clientele regarding effective practices that meet organic standards. Includes information on organic systems plans, principles of organic production, and organic marketing and economics.

Organic Materials Review Institute (OMRI)

www.omri.org

List of materials compatible in organic farming, brand name review, technical information.

UC Sustainable Agriculture Research and Education Program (SAREP)

www.sarep.ucdavis.edu/

Sustainable agriculture news, technical information, grant programs, Biologically Integrated Farming Systems program.

USDA National Organic Program

www.ams.usda.gov/nop/

Regulations on certification, materials, and labeling for organic producers and processors.

USDA Natural Resources Conservation Service: Soils

www.nrcs.usda.gov/wps/portal/nrcs/site/soils/home/

Includes information on soil taxonomy and soil classification resources, soil surveys, as well as a guide on how to receive soil conservation assistance.

USDA Natural Resources Conservation Service: Soil Health

www.nrcs.usda.gov/wps/portal/nrcs/main/soils/health/

A comprehensive portal to information on soil health, including soil biology, health assessment, health management, and extensive lists of resources and publications.

VIDEO RESOURCES

Symphony of the Soil. 2012. Directed by Deborah Koons Garcia (103 minutes).

www.symphonyofthesoil.com

An artistic and scientific exploration of soil, examining its complex dynamics as well as the human relationship with soil, the use and misuse of soil in agriculture, deforestation and development, and the latest scientific research on soil's key role in ameliorating the most challenging environmental issues of our time. Filmed on four continents, featuring esteemed scientists and working farmers and ranchers.

SUPPLEMENT 1

A Soil Primer with Sustainable Management Strategies

Soil is often thought of as an inert substrate, useful in propping up plants and a mere vehicle for applied fertilizer and water. It is, in reality, a distinct ecosystem, defined as a system formed by the interactions of a community of organisms with their physical environment.

Although we tend to take it for granted, human society is principally possible only because the earth's crust is "dusted" with a thin and often fragile layer of life-supporting material on which we can grow food: the soil.

Two distinct parts of the soil—the biotic and abiotic components—function together to form a stable system. The biotic, or living (or that which was once alive) component is comprised largely of living plants, living organisms (macro and micro), and organic matter (plant and animal residues), which can be fresh, partially decomposed, or fully stabilized (humus). Soil's abiotic component is made up of minerals, air, and water.

By understanding the soil's ecosystem, growers can harness and promote the biotic components with judicious additions of compost and "green manures" (cover crops worked into the soil) to create a healthy environment for plant growth, and thus virtually eliminate the need to apply purchased fertilizer. This can lower costs—both out of pocket and environmental.

This supplement introduces the soil's four basic components and three major properties, discusses how these interact, and describes ways that gardeners and farmers can improve their soils by learning how to become "biological growers."

Soil's Four Components

When you pick up a handful of soil, only half of that volume is solid material (minerals and organic matter). The other half should be pore space occupied by air (25%) and water (25%). Thus soil consists of four basic components:

1. Mineral (45%, + or -, by volume): The mineral component of soil consists of rocks ground down over geologic time as a result of physical, chemical and biological actions. Think of it as rock or stone "flour."

- 2. Organic matter (5%, + or -):** Organic matter is made up of a wide range of organic (carbon-containing) substances, including living organisms, plant biomass, and the carbonaceous remains of organisms and plants. Some soil microorganisms break down the remains of plants, animals, and other microorganisms; others synthesize new substances.
- 3. Soil air (25%):** Soil air occupies the interstitial spaces between soil particles. Its primary role is to provide oxygen to fuel the aerobic (oxygen-requiring) activities of microorganisms and plant roots. Soil bacteria that associate with roots of legumes such as beans and peas use the nitrogen component of soil air to "fix" nitrogen in a form that plant roots can assimilate.
- 4. Water (25%):** Soil water or the soil solution carries dissolved nutrients that flow to and are actively intercepted by plant roots. Thus the soil solution is the vehicle for nutrients to "flow" into plants and, along with the products of photosynthesis, "grow" the plant. The soil solution also gives plants their turgor and rigidity.

◀ **FIGURE 1.1 | SOIL COMPOSITION:**
AN IDEALIZED SOIL

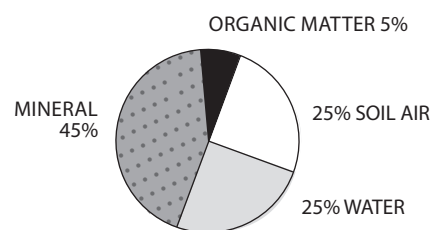

Soil's Three Distinct Properties: Physical, Chemical, and Biological

Physical properties of soil are divided into texture and structure.

Soil texture is a physical measurement of the percentage of sand, silt, and clay particles in a soil (as determined by grain size, with sandy soils being the largest and clay the smallest). It is a given, and cannot be altered (see more in Unit 2.1, Soil Physical Properties).

Sandy soils usually feature low nutrient- and water-holding capacity and an associated lower organic matter content. On the plus side, sandy soils drain well, warm quickly, and allow early cultivation and planting in the spring. Clay soils are the opposite: they carry high levels of nutrients and water, but are often difficult to work. You can determine soil texture by a simple field “feel” test called ribboning, or have it measured with a lab soil test.

Soil structure refers to the arrangement of individual soil particles (sand, silt, clay) into aggregates or “clumps”; ideally, it takes the form of a granular or crumb structure, much like the cross section of a loaf of good whole grain bread. Such a structure features an amalgamation of small, intermediate, and large, stable aggregates. Some major contributors to stable aggregates and good soil structure are:

- The addition of organic matter—fresh, as green manures, and stabilized, as finished compost. Organic matter is a feedstock for soil microorganisms that break down the organic materials and in the process exude mucilaginous glues and slimes that help bind soil particles into stable aggregates. Plant roots, both living and decomposed, also contribute “binding” substances to the system.

- Timely and skilled cultivation techniques—rough plowing or digging physically forces soil particle contacts, beginning the process of aggregation. Organic matter contributes to stabilizing the aggregates that form. Note: Too much cultivation (especially secondary cultivation, or pulverizing) damages soil structure, as does working a soil when it's too wet. See details about cultivation in Unit 1.2, Garden and Field Tillage and Cultivation.

Chemical properties of a soil measure its nutrient-carrying capacity and pH (acidity; see Unit 2.2, Chemical Properties of Soil). These are best determined by a soil test.

Biological properties of the soil refer to the “community of creatures” that live in and form the soil,

principally bacteria, fungi, and actinomycetes (microorganisms that are especially effective in breaking down hard-to-decompose compounds, such as chitin; see Unit 2.3, Soil Biology and Ecology).

While the three properties of soil are discreet, they are also synergistically interactive—think in terms of a Venn diagram.

Some examples:

- By providing a “feedstock” for soil's biological components with compost, green manures, and fertilizers, you stimulate microbial populations. These microbes break down organic matter so that it can be dissolved in soil water and taken up by plants for growth. The microbes, in turn, die and contribute their own organic materials to the organic matter content of the soil. Thus by “working smart instead of hard,” as Buckminster Fuller once said, you improve the chemical property of your soil by promoting the biological properties.
- Similarly, by adding organic matter at least once a year, and using timely, skilled cultivation techniques, you create good soil aggregation and improve soil structure (a physical property). This creates large, continuous “pore spaces” in the soil; with their balance of air and water, these pore spaces create a favorable habitat for the microbes and plant roots that live and grow there. Thus you harness the physical properties of a soil to create and maintain hospitable conditions for soil organisms and plants (the biological properties).

A Biological Approach to Managing Soils

In Europe they refer to organic growers as biological growers, which is probably a more appropriate and descriptive term. While all aspects of soil analysis and management are critical, the twin engines of soil biology and organic matter inputs coupled with the appropriate style and frequency of cultivation drive the system of a biological-ecological approach to soil management.

Although it makes up only 3–5% of the soil, organic matter has a pronounced influence on all soil properties. When added to the soil, it yields:

- A sufficient nutrient supply
- An open, permeable soil surface that allows air/gas exchange to replenish the soil's oxygen content, and makes it easy for water to enter, percolate through, and drain out of the root zone

- A “feedstock” to nourish microbes
- A low population of soil-borne plant diseases and pathogens
- A high population of beneficial soil microorganisms
- Good soil consistency, that is, the ability to resist degradation (compaction, erosion, etc.)
- Good tilth, which refers to the “workability” of a soil

Short of calling it a panacea, whatever the problem with soils, the answer is almost always to add organic matter in the form of compost and/or green manures from cover crops:

- On a mono-grained, structureless sandy soil it creates aggregation and aids with moisture and nutrient retention, building the “body” of a soil.
- On a sticky clay it adds more continuous macropores from the surface to the subsoil. This type of pore system reduces puddling, crusting, and erosion of surface soils and allows easy root growth.
- It also increases the aerobic (oxygen) content of clay soils, thus facilitating better root growth and a flourishing biological community.

One of organic matter’s key properties is that it provides nutrients both for immediate use by microbes and plant roots, and also holds and releases nutrients over time. This is especially true of nitrogen, the most volatile and motile (moveable) of all nutrients, and the one needed by plants in the largest quantity.

On a soil test, the estimated nitrogen release (ENR) is a reflection of the amount of organic matter in a soil (3–5% organic matter is considered good for California soils), as well as the organic matter’s ability to release nitrogen each growing season. ENR is expressed in pounds/acre, where >80–100 pounds is considered good. Along with a nitrate nitrogen reading (20–40 parts/million is adequate), knowing the percent of organic matter in your soil helps to determine whether you need to add nitrogen as a fertilizer.

Assessing and Amending Your Soil

One good way to assess the overall chemical properties (including nutrient content) of a soil is to get a professional lab soil test. For example, A&L Western Agricultural Labs in Modesto, California (www.al-labs-west.com) is an excellent lab with good customer service, and their test results will give you an

accurate baseline as per the macro and micronutrients plus the pH of your soil. Peaceful Valley Farm Supply (www.groworganic.com) sells an easy-to-use booklet, *Understanding Your Soil Analysis Report*, that will help you interpret the results and makes recommendations for addressing deficiencies.

With soil science there is no alchemy, which is to say, if a nutrient is deficient you have to add it. Once added, it can be managed for both availability and retention. For instance, phosphorus facilitates early root growth, flowering, fruiting, sugar development, and energy transfer within plants. Organic sources include bone meal, oyster shell flour rock, and colloidal rock phosphate.

Once added to the soil, phosphorus is relatively immobile—that is, it doesn’t readily leach downward as does nitrogen. But it is quickly “locked up” by both aluminum and calcium in the soil, and thus unavailable for plant growth. As a biological soil manager you can grow phosphorus-concentrating crops such as brassicas, legumes, and cucurbits, then use them for compost or as green manure to work the phosphorus in their plant parts into the organic fraction of the soil, where it will be available to crops.

Another strategy is to add a dusting of colloidal rock phosphate powder to manure layers in a compost pile. Nitrifying bacteria proliferate in manure and they also consume and immobilize the phosphorus, then “give it up” as they die and decompose. Again, it becomes available in the organic matter fraction of the soil when the finished compost is applied.

Closing tips:

- Cultivate judiciously and skillfully (see *Soil Cultivation: Fundamental Concepts and Goals* in Resources)
- Add organic matter at least once a year as compost or green manures from cover crops
- Don’t water excessively, as water leaches nutrients and when applied heavily via overhead or furrow irrigation can damage soil structure and reduce the aerobic (air-holding) capacity of a soil
- Protect the soil surface, either with a living mulch (cover crops), or straw, chips, etc.
- Minimize soil compaction
- Get a lab soil test done and use the results to develop a fertility management plan. Then monitor the soil via periodic tests every 1–3 years to see if your plan is working.

SUPPLEMENT 2

The Global Socio-Environmental Effects of Soil Erosion

Soil erosion is the natural process of detachment and movement of surface soil by water or wind, and has occurred simultaneously with soil formation on the Earth for millennia. In natural ecosystems the formation of soil from decomposing plant and animal matter occurs in balance with the rate of erosion, maintaining overall soil health and fertility and preventing a net loss of topsoil. In the last several centuries, however, human activities have increased the rate of soil erosion, currently outpacing soil formation by 10 times in the U.S. and 40 times in China and India.

In the last 40 years, 30 percent of the world's arable land has become unproductive and 10 million hectares (about 25 million acres) are lost each year due to erosion.¹ Additionally, accelerated erosion diminishes soil quality, thereby reducing the productivity of natural, agricultural and forest ecosystems. Given that it takes about 500 years to form an inch of topsoil, this alarming rate of erosion in modern times is cause for concern for the future of agriculture. This supplement explores the major causes of soil erosion and the social impacts it has on communities, underscoring the importance of agricultural practices that prevent or minimize erosion.

Anthropogenic causes of accelerated soil erosion are numerous and vary globally. Industrial agriculture, along with overgrazing, has been the most significant contributor, with deforestation and urban development not far behind.^{2, 3, 4} Heavy tillage, fallow rotations, monocultures, and marginal-land production are all hallmarks of conventional agriculture as it is variably practiced around the world and significantly encourage accelerated soil erosion. Repeated tillage with heavy machinery destroys soil structure, pulverizing soil particles into dust that is

easily swept up by wind or water runoff. Fallow rotations, common with cash crops around the world and subsidized in bio-fuel production in the U.S., leave land vulnerable to the full force of wind gusts and raindrops. Monocultures tend to be planted in rows, exposing the soil between to erosion, and are commonly associated with fallow rotations. More and more marginal land, land that is steep and particularly susceptible to water erosion, is being planted by farmers either attracted by higher crop prices or forced by loss of productivity on flatter, but already eroded lands. In an increasingly complex global food web, seemingly separate causes of erosion begin to influence each other, magnifying their effects. For example, deforestation of tropical forests in Brazil clears the way for industrial soybean production and animal grazing to feed sprawling urban populations in the U.S. All the while, fertile topsoil is carried away by wind and water at alarming rates.

Environmental harms resulting from accelerated erosion are well documented. Decreased soil fertility and quality, chemical-laden runoff and groundwater pollution, and increased flooding are just a few of these detrimental effects. There are, in addition, disproportionate social harms resulting from high rates of erosion that are less obvious, but no less directly linked. Hunger, debt, and disease are serious problems in mostly poor, rural communities around the world that are exacerbated by accelerated erosion.

As global agricultural development and trade have accelerated in the last half-century, mainly via the “green revolution” and the formation of the World Trade Organization (WTO), increasing trade

1, 2 Pimentel, David. 2006. Soil erosion: a food and environmental threat. *Environment, Development and Sustainability*, 8: 119–137.

3 Montanarella, Luca. Soil at the interface of agriculture and environment. Agriculture and Environment, the European Commission. ec.europa.eu/agriculture/envir/report/en/inter_en/report.htm

4 Mmbaga, John. 2013. How human activity affects soil erosion. *Sciences 360: Ecology and Environment*. www.sciences360.com/index.php/how-human-activity-affects-soil-erosion-849/

pressures have raised export crop production in less developed countries. As a result, farmers mainly in Asia, Latin America, and sub-Saharan Africa are increasingly abandoning traditional farming techniques and locally significant crops in favor of adopting the industrial practices mentioned above that lead to high rates of erosion.⁵ While development institutions and governments proclaim concerns for the rural environment, agricultural policy supporting high commodity prices and limited credit access continually pushes farmers to intensify land use. Coupled with the fact that the total area of arable land in cultivation in these parts of the world is already very high (e.g., 80% in South Asia), land degradation by soil erosion threatens food security by removing from cultivation land sorely needed for domestic food production. The majority of the world's 868 million undernourished people live in Eastern and Southern Asia and sub-Saharan Africa.

One of the international responses to soil degradation in the developing world has been to promote soil conserving tillage practices known as minimum- or no-till agriculture. No-till agriculture protects soil by leaving crop residue on the field to decompose instead of plowing it into the ground before planting the next crop. Weed management is addressed with heavy herbicide use to make up for the loss of weed control from tillage. The practice, extensively adopted in the U.S., has been popular in Brazil and Argentina, and much effort is being expended to expand no-till to Asia and Africa.

There are, however, costs associated with no-till agriculture, both economic and social. First, no-till agriculture is expensive to adopt. Herbicides, seed drills, fertilizers, and other equipment require a high initial investment not possible for poor farmers without incurring significant debt. Second, heavier herbicide use increases human exposure to chemicals and contributes to water and air pollution. Third, weed pressures can change in unexpected ways as reliance on a handful of herbicides breeds resistance. Weed resistance to the popular herbicide, glyphosate, is an increasing concern in conventional agriculture and is leading to development of more harmful herbicides to compensate for glyphosate's reduced effectiveness. Lastly, no-till agriculture also

promotes monoculture cropping systems that, as described above, have a deleterious effect on soil quality.

The techniques illustrated in this manual emphasize long-term soil stewardship using an integrated approach to soil health and management. For example, cover crops hold soil aggregates together in the wet season, protecting soil from the erosive effects of rain. Properly timed tillage limits its destructive effects on soil particles and soil structure. Compost promotes a healthy soil ecosystem, improving soil's structure and its ability to more successfully withstand wind and water erosion.

In addition to environmental benefits, agroecological systems^{6,7} are often based on traditional farming practices that promote soil-conserving techniques and varietal choices adapted to the particular region, stemming the tide of land consolidation and commodity crop production. Food security is enhanced and debt risk reduced by way of diverse cropping systems and labor-intensive, rather than input-intensive, production methods. And there are public health benefits from eliminating exposure to harmful pesticides and herbicides. In sum, the serious challenge presented by accelerated soil erosion coupled with the uncertainty about whether no-till agriculture's benefits outweigh its harms underscores the importance of employing an agroecological approach to farming that prevents soil erosion on farms.

5 Kwa, Aileen. Agriculture in developing countries: which way forward? Occasional Papers 4. Trade-Related Agenda, Development and Equity (T.R.A.D.E.). focusweb.org/publications/2001/agriculture_which_way_forward.html

6 Silici, Laura. 2014. Agroecology: What it is and what it has to offer. IIED Issue Paper. International Institute for Environment and Development, London. Available online at: pubs.iied.org/pdfs/14629IIED.pdf?

7 Gliessman, Stephen R. 2014. *Agroecology: the Ecology of Sustainable Food Systems 3rd Edition*. Boca Raton, FL: CRC Press, Taylor Francis Group.

Garden and Field Tillage and Cultivation

Introduction	33
Lecture 1: Overview of Tillage and Cultivation	35
Lecture 2: French Intensive Method of Soil Cultivation	41
Lecture 3: Mechanical Field-Scale Tillage and Cultivation	43
Demonstration 1: Preparing the Garden Site for French-Intensive Soil Cultivation	
Instructor's Demonstration Outline	45
Students' Step-by-Step Instructions	49
Demonstration 2: French-Intensive Soil Cultivation	
Instructor's Demonstration Outline	53
Students' Step-by-Step Instructions	57
Hands-on Exercise	61
Demonstration 3: Mechanical Tillage and Cultivation	63
Assessment Questions and Key	65
Resources	68
Supplements	
1. Goals of Soil Cultivation	69
2. Origins of the French-Intensive Method	72
3. Tillage and Bed Formation Sequences for the Small Farm	74
4. Field-Scale Row Spacing	76

Glossary	79
Appendices	
1. Estimating Soil Moisture by Feel	80
2. Garden-Scale Tillage and Planting Implements	82
3. French Intensive/Double-Digging Sequence	83
4. Side Forking or Deep Digging Sequence	86
5. Field-Scale Tillage and Planting Implements	89
6. Tractors and Implements for Mixed Vegetable Farming Operations Based on Acreage	93
7. Tillage Pattern for Offset Wheel Disc	94

Introduction: Soil Tillage & Cultivation

UNIT OVERVIEW

Cultivation is a purposefully broader concept than simply digging or tilling the soil—cultivation involves an array of tools, materials and methods that, when properly combined, promote and maintain optimum soil health and good tilth, a composite term for the overall physical characteristics of a soil (texture, structure, permeability, consistency, drainage, and water-holding capacity). In short, tilth equals the workability of a soil in relationship to its ability to grow plants.

This unit introduces students to the tools, techniques, and rationale behind traditional French-intensive organic gardening and mechanized, field-scale soil cultivation. Beginning with the concepts of soil cultivation and tillage, students will learn about the aims of cultivation, and the appropriate applications of primary and secondary tillage techniques.

Through demonstrations and a hands-on exercise, students will begin to develop the technical skills needed to cultivate French-intensive raised beds using both primary and secondary tillage tools and techniques, and will become familiar with the various tillage tools and processes used in mechanical cultivation and bed formation. Unit supplements detail cultivation goals, particularly at the garden scale; discuss tillage and bed formation sequences, and the importance of row spacings at the field scale; as well as the origins of the French intensive method.

MODES OF INSTRUCTION

> LECTURES (3 LECTURES, 1–1.5 HOURS EACH)

Lecture 1 covers the definition of cultivation and tillage, the general aims of soil cultivation, the factors influencing cultivation approaches, and the potential impacts of excessive or ill-timed tillage.

Lecture 2 includes a brief history of the French-intensive method of cultivation and the tillage tools and techniques used to prepare garden beds with this method.

Lecture 3 addresses tillage tools, techniques, and sequences used in field-scale mechanized production systems.

> DEMONSTRATION 1: PREPARING THE GARDEN SITE FOR FRENCH-INTENSIVE CULTIVATION (1.5 HOURS)

Demonstration 1 outlines the steps for preparing a site for French-intensive permanent raised beds.

> DEMONSTRATION 2: FRENCH-INTENSIVE CULTIVATION (1.5 HOURS)

Demonstration 2 outlines the steps for demonstrating the cultivation and maintenance of French-intensive permanent raised beds using primary and secondary cultivation.

> HANDS-ON EXERCISE: GARDEN BED CULTIVATION (2 HOURS)

In this exercise, students practice cultivating permanent raised beds using traditional French-intensive cultivation techniques.

> DEMONSTRATION 3: MECHANICAL TILLAGE AND CULTIVATION (1.5 HOURS)

The Demonstration 3 outline details the steps for demonstrating tractor-mounted tillage and cultivation equipment.

> ASSESSMENT QUESTIONS (1 HOUR)

Assessment questions reinforce key unit concepts and skills.

> POWERPOINT

See casfs.ucsc.edu/about/publications, and click on Teaching Organic Farming & Gardening.

LEARNING OBJECTIVES

CONCEPTS

- The definitions of cultivation and soil tillage
- The objectives of soil tillage
- The factors influencing the timing and type of tillage used
- The primary features and rationale behind the French-intensive raised bed method of tillage
- The primary features and rationale behind modern mechanical/field-scale methods of soil tillage
- The positive and negative effects of tillage on the physical, chemical, and biological properties of the soil
- Definitions and applications of primary and secondary tillage techniques
- Field equipment and common soil preparation sequence used in primary and secondary tillage

SKILLS

- How to evaluate and adjust soil moisture to within a proper range prior to soil cultivation
- How to evaluate soil conditions to determine the need for/type of cultivation
- How to use primary and secondary soil cultivation techniques to develop and maintain French-intensive raised beds

Lecture 1: Overview of Soil Tillage & Cultivation

Pre-Assessment Questions

1. What is soil cultivation?
2. What is tillage?
3. What are some possible positive consequences of soil cultivation?
4. What are some possible negative consequences of intensive and frequent soil tillage on soil quality?

A. Defining Soil Cultivation and Soil Tillage

1. Cultivation: The total assemblage of tools and techniques used to develop and maintain soil fertility and crop production in garden and farm systems
2. Tillage: The operation of implements through the soil to prepare seedbeds

B. Aims of Soil Cultivation (see also Supplement 1, Goals of Soil Cultivation)

1. To promote and maintain good soil structure and tilth, a composite term for the overall physical characteristics of a soil (such as texture, structure, permeability, consistence, drainage, and water-holding capacity)
Primary cultivation loosens and opens untilled or compacted soils, allowing greater ease of root penetration and more desirable air/gas and water relations. Cultivation promotes soil particle aggregation by vertically distributing organic matter (e.g., cover crops, compost) and soil amendments, which provide energy and nutrients to the soil organisms responsible for soil aggregate formation. The rearrangement of soil particles encourages the formation of chemical bonds that also create soil aggregates. Secondary cultivation decreases surface soil particle size to produce a quality seedbed.
2. To prevent or break up soil hard pans
Deep cultivation can physically fracture compacted and otherwise impervious soil layers or "hard pans," allowing more thorough aeration, the incorporation of soil amendments, and greater ease of root development. There are both naturally occurring and human created soil hard pans.
 - a) Clay pan: Produced when clay particles leach downward and settle, forming a distinct dense soil layer (e.g., alluvial soils)
 - b) Plow pan: Created by repeated mechanical tillage to a similar depth
 - c) Traffic pan: Produced through repeated foot traffic or animal grazing, especially when soils are moist (also known as "cow pan")
3. To aerate the soil
 - a) Cultivation increases soil air/gas exchange with the atmosphere. Cultivation timed to take place when beds are appropriately moist (50%–75% of field capacity) immediately increases soil pore space and aeration, allowing for the rapid diffusion of atmospheric gases into the soil. These gases, which include nitrogen, oxygen, and carbon dioxide, are vital components of soil air that are critical for plant growth. Proper cultivation techniques and the addition of organic matter and soil amendments encourage the development of good crumb structure. This creates a more permanent network of pore spaces, allowing for the continual, passive exchange of atmospheric and soil gases, ease of penetration by plant roots, and water infiltration, percolation, and drainage.
 - i. Nitrogen (N_2): Increased atmospheric nitrogen (N_2) levels in the soil can be used by both soil and root bacteria to fix plant-available forms of nitrogen such as nitrate (NO_3^-) and ammonium

- ii. Oxygen (O₂): When combined with organic matter inputs, elevated soil oxygen levels may increase soil biological diversity, stimulate soil biological activity, and increase the rate of microbial decomposition of organic matter in the soil. Soil aeration replenishes the soil oxygen reservoir that is continually being taken up through plant roots for use in respiration.
 - iii. Carbon dioxide (CO₂): Cultivation allows for the movement of CO₂ out of the soil, to be replaced with oxygen and nitrogen
 - b) Increase water infiltration, percolation, retention, and drainage characteristics. A soil made more permeable through proper tillage allows water to infiltrate the soil and percolate slowly downward, draining into the subsoil at rates optimal for both crop plants and soil microbes.
 - c) Soil aeration increases the rate of mineralization and the release of plant-available nutrients into the soil solution for uptake by plant roots
4. To increase the temperature of cold soils in the spring
- Soil air warms more quickly than soil water and soil solids. Soils with well-developed aggregations and adequate pore space maintain more desirable drainage characteristics and therefore dry and increase in temperature more rapidly than soils having fewer pore spaces. Biological activity and biogeochemical reactions increase at higher soil temperatures, with soil temperatures of 50–55°F being a threshold below which soil microbial activity rates and plant growth slow dramatically.
5. To incorporate soil amendments
- Cultivation is a practical means of incorporating compost and other soil amendments, including mineral and non-mineral fertilizers, cover crops, and crop residues. Cultivation may be used to incorporate soil amendments to desired soil depths in order to increase the immediate or long-term availability of essential plant nutrients or to improve the physical, biological, and/or chemical properties of the soil.
- a) Composts, manures, and fertilizers: Tillage and cultivation techniques are needed to incorporate organic matter amendments beneath the soil surface in order to avoid the loss of carbon and volatile nitrogen compounds through surface oxidation. Tillage may also be used to evenly distribute organic matter amendments for general soil improvement or to place fertilizers in particular locations for specific short-term crop nutrient requirements (i.e., banding).
 - b) Incorporation of mineral amendments and other soil amendments (e.g., bone meal, fish meal, etc.): Soil amendments must be incorporated into the soil to allow for additional biological or chemical decomposition and to liberate and cycle essential plant nutrients
6. To manage crop residues and cover crops (see also Unit 1.6, Selecting and Using Cover Crops)
- a) Crop residues: Tillage is used both in hand-worked gardens and in mechanized systems to incorporate crop residues. This process cycles the organic matter and nutrients held in the crop tissues back into the soil and prepares the site for subsequent cropping.
 - b) Cover crops: Tillage is also used to incorporate cover crops in order to cycle organic matter and nutrients held in the cover crop tissues back into the soil and to prepare the site for subsequent cropping. The nutrients liberated as cover crops decompose may be a significant source of essential plant nutrients for a given season's crop production.
7. To control weeds (see also Unit 1.10, Managing Weeds)
- Cultivation is a practical means of destroying annual weeds and weakening crowns and rhizomes of perennial weeds. Because cultivation stimulates germination of annual weed seeds, multiple cultivations prior to transplanting or direct sowing as well as throughout the crop cycle may be needed to reduce the soil weed seed bank and thereby reduce weed competition with cultivated crops.

8. To create particulate seedbeds

Secondary tillage techniques may be used to render surface soil particle sizes in proper proportion to the size of the transplant or seed being sown. Fine-seeded crops (e.g., carrots, arugula) and transplants with small root systems (e.g., lettuce, alliums) require a fine or small surface soil particle size. Large-seeded crops (e.g., squash, beans, corn) and large, vigorous transplants (e.g., tomatoes) may be placed in a more coarsely tilled soil.

9. To manage plant pathogens and insect pests

Timely plowing under of crop residue can be an effective means of controlling (or minimizing) certain insect pests and plant pathogens

10. To retain soil moisture

Secondary tillage techniques may be used to intentionally pulverize the surface soil. This practice creates a fine dust layer that interrupts the capillary action of water, thereby reducing the loss of soil moisture to the atmosphere through evaporation. Such methods are frequently used to conserve soil moisture in non-irrigated (dry-farmed) farming operations. See Supplement 3, Overview of Dry Farming, in Unit 1.5, Irrigation—Principles and Practices, for information on dry farming practices and applications.

C. Types of Soil Tillage (see Appendices 2 and 5, Garden-Scale Tillage and Planting Implements, and Appendix 3, French Intensive/Double-Digging Sequence for a garden-scale example)

1. Primary tillage

a) Defined: Course and deep tillage that fractures, sifts, or mixes the top six inches to two feet of soil. Primary tillage is applied to soils in order to eliminate soil pans, incorporate organic matter and other soil amendments, incorporate cover crops and crop residues, and aerate soils. Tools used for primary tillage include:

- i. Hand scale: Spade and fork or U-bar
- ii. Small scale: Walk-behind tractor implements such as rotary plow or rototiller
- iii. Field scale: Often accomplished with a tractor implement such as plow, spader, chisels, offset discs, rotary tiller, or lister plow

2. Secondary tillage

a) Defined: Shallow and fine tillage. Secondary tillage produces a fine seed or transplant bed by a series of operations that reduces the surface soil particle size. Secondary tillage tools and techniques are applied to the top 3 to 6 inches of soil and used to form fine, level, firm planting beds following primary cultivation. Tools used for secondary tillage include:

- i. Hand scale: Tilthing forks and rakes
- ii. Field scale: Disc harrows, spring- and spike-toothed harrows, landplanes

3. Surface cultivation or cultivation tillage

a) Defined: Shallow, post-planting tillage used to loosen and aerate compacted soils, hill soil, and/or eradicate unwanted vegetation growing around cultivated crops. Tools used for surface cultivation or cultivation tillage include:

- i. Hand scale: Various hoes—co-linear, hula, etc., along with hand weeding
- ii. Field scale: power incorporators and large rototillers, cutting knives and sweeps, spring-toothed harrows

D. Factors Influencing Timing and Type of Tillage

1. Soil moisture

Soil tillage at both the garden and field scale should take place only within the soil moisture range of 50–75% of field capacity (see Appendix 1, Estimating Soil Moisture by Feel, and Unit 1.5). Whether using a spade and fork, or tractor-drawn tillage tools, tillage executed at soil moisture levels higher than 75% of field capacity can increase soil compaction, degrade soil structure, increase surface crusting, and increase erosion potential. Soil tillage undertaken when soil moisture is below 50% of field capacity may pulverize soil aggregates, resulting in poor soil structure and increasing the risk of soil erosion due to wind.

2. Soil texture classification (see also Unit 2.1, Soil Physical Properties)

- a) Sandy soil: Sandy soils with relatively large particle size and large pore spaces are often naturally well drained, aerated, and friable. These features, combined with the relatively inert nature of the sand particles, lead to soil conditions in which organic matter oxidizes rapidly and unstable soil aggregates form. Though less susceptible to compaction when tilled outside of the ideal moisture range, tillage systems in sandy soils must generally be conservative in order to retain soil aggregates and maintain desirable soil physical properties.
- b) Clay soil: Soils with a high percentage of clay (>40%) have many micropore spaces and often exhibit poor drainage and gas exchange characteristics. Heavy clay soils often require an extended period (5–7 or more years) of frequent, deep tillage in order to incorporate adequate amounts of mineral soil amendments and organic matter to create the desirable soil physical conditions. Clay soils must be worked at optimal soil moistures (50–75% field capacity) to avoid creating clods—large and compacted soil masses—that lead to soil physical properties of poor quality.

3. Climate

Temperature, evaporation, and precipitation strongly influence soil development, so that Arctic, tropic, temperate, and arid regions all tend to develop different types of soil. Temperature, evaporation, and precipitation influence the degree and duration of seasonal soil biological activity, which in turn determines the mineralization rates of soil organic matter and the degree of organic matter accumulation in a given soil. Generally, the greater the number of days with soil temperatures below 50°F and the higher the annual amounts of precipitation, the greater the accumulation of soil organic matter.

- a) Arid climates: Low annual precipitation resulting in sparse vegetation and little organic matter accumulation. Cultivation should be limited to preserve soil organic matter. Due to low precipitation and reduced nutrient leaching, arid soils are often potentially very fertile with the addition of irrigation and organic matter inputs.
- b) Temperate climates: Cooler temperatures and high organic matter accumulation. Spring tillage is often necessary to increase soil temperatures and improve drainage through soil aeration.
- c) Tropical climates: High annual temperatures, precipitation, and humidity tend to maintain soil biological activity and the continual oxidation of soil organic matter. Nutrients and organic matter are often disproportionately held in the vegetative cover. Cultivation should be minimized to reduce additional losses of soil organic matter. Cultivated soils in areas with heavy rainfall should be protected from the erosive effects of heavy rains through the use of mulches and cover crops.

4. Season (temperate climate)
 - a) Spring: Period of most extensive cultivation in temperate region. Deep tillage is often used to remove or incorporate cover crops, aerate and warm cold soils, incorporate mineral and organic matter soil amendments, and create planting beds for seed or transplants.
 - b) Summer: Period of light tillage and surface cultivation for successive cropping
 - c) Fall: Deep cultivation is frequently used to prepare soils for fall and overwintering crop production in moderate climates with high annual winter rainfall. Deep cultivation counters the cumulative soil-compacting effects of rains and helps assure adequate winter drainage. Tillage is often used in the fall to incorporate mineral and organic matter soil amendments prior to sowing cover crops.
 - d) Winter: Period of little or no cultivation
5. Cropping system
 - a) Annual cropping system: Annual cropping systems feature intensive cropping of nutrient-demanding plants, which necessitates a high frequency of soil tillage, resulting in both organic matter and plant nutrient losses. Annual cropping systems demand high inputs of organic matter and mineral amendments to counter losses.
 - b) Perennial cropping system: Perennial cropping systems require little or no tillage after initial planting and demand only periodic surface cultivation or mowing to manage competing vegetation; note that the material in this manual refers mainly to annual row crop systems
6. Soil condition
 - a) Soils of good tilth: Soils with well-developed physical and chemical properties often require less intensive tillage and are maintained by incorporating soil amendments into the top 4–12 inches of soil. The physical properties (structure and bulk density) of such soils should be monitored and, when necessary, periodically deeply tilled to disrupt soil compaction and incorporate organic matter soil amendments, which encourage soil aggregate formation.
 - b) Soils with physical properties of low quality: Untilled ground and soils with surface or sub-soil compaction are initially deeply tilled each year, using double digging on a garden scale and mechanical spading or chisel plowing on a field scale. This deep tillage—combined with planting deep-rooted cover crops—fractures compacted soil layers and distributes soil amendments throughout the soil profile, encouraging development of soil aggregates and reducing soil bulk density. Once the physical properties of the soil have been developed/improved, less intensive tillage techniques may be used for maintenance purposes.

E. Possible Impacts of Frequent and Intensive Soil Cultivation

Frequent and intensive soil cultivation (along with excessive tractor and foot traffic)—especially if done when the soil is too wet—can lead to a number of negative impacts on soil structure. Possible impacts include:

1. Decreases in soil organic matter content: Intensive cultivation in irrigated soils increases and sustains the oxidation rate of soil organic matter. Without periodic replacement of organic matter, soils subjected to intensive tillage will become exhausted of their active humus content, leading to the degradation of soil biological, physical, and chemical properties.

2. **Eventual reduction in soil biological activity and diversity:** Soil organic matter is the energy source for many soil organisms. Soils with low or exhausted soil organic matter cannot support large populations or a great diversity of soil microbes, which are responsible for the liberation of plant nutrients, disease suppression, and the development and maintenance of certain physical properties of the soil, particularly aggregation and overall granular/crumb structure.
3. **Destruction of soil aggregates:** Soil aggregates may also be pulverized, compacted, or degraded through oxidation during tillage. Excessive tillage or continuous tillage without the replenishment of organic matter will result in the eventual loss of soil organic matter.
4. **Reduction in nutrient- and water-holding capacity of the soil:** Soil organic matter is a reservoir of all essential plant nutrients, significantly contributing to the cation exchange capacity of the soil. Soil organic matter holds many times its weight in water, buffering the soil against extreme moisture variations.
5. **Loss of soil pore space and decreased gas exchange:** Loss of soil organic matter and degradation of soil structure result in loss of soil pore space (indicated by increased bulk density readings on a soil test) and reduce the soil's ability to passively exchange gases with the atmosphere
6. **Reduction in drainage:** Loss of soil organic matter and degradation of soil structure reduce the soil's ability to readily drain excess moisture
7. **Increased susceptibility to soil erosion:** The loss of soil organic matter from excessive tillage results in an overall reduction and weakening of soil aggregates and reduces soil's ability to hold together as a cohesive mass. Soils with few or unstable aggregates are not as resistant to the erosive forces of irrigation or rainwater and easily detach and travel with moving surface water.
8. **Disruption of earthworm habitat:** Frequent and deep cultivation and the aeration of the soil environment disrupt earthworm habitat, kill some earthworms in the process of cultivation, and expose others to predation
9. **Decline of soil quality and increased susceptibility of crop plants to pests and pathogens**

F. Indicators of Poor or Excessive Cultivation

There are several quantitative and qualitative indicators of poorly timed and executed or excessive cultivation

1. **Bulk density, a measure of the weight or volume of soil (solids and pore space).** A low bulk density reading indicates good aggregation/soil structure. Increased bulk density readings indicate a deterioration of soil structure and reduced pore space as the soil becomes more compacted.
2. **Decrease in organic matter content, as measured by a soil test**
3. **Deterioration of soil structure/aggregates, especially aggregate stability, which can be measured with a simple DIY test and comparative visual observation.** To test for aggregation, drop a handful of soil in a glass of water: if it stays together, there is good aggregate stability. Pulverized soil will fall apart.
4. **Surface crusting, as aggregates break down**
5. **Reduction of estimated nitrogen release (ENR) as measured by a soil test.** ENR is proportional to the % organic matter of the soil and is a measurement of the anticipated annual release of N from soil organic matter by microbial action. It is usually given in #/acre (see also Unit 1.11, Reading and Interpreting Soil Test Reports).

Lecture 2: French-Intensive Method of Soil Cultivation

A. The French-Intensive Method of Soil Cultivation

1. Development of the French-intensive system
 - a) Defined as a method of gardening that features handworked, deeply dug beds amended with compost and other organic inputs, carefully managed and planted at an “intensive” spacing to maximize production and minimize weed pressure
 - b) Based on a system of intensive gardening started in the 1500s and popularized by Parisian market gardeners in the 1800s into the early 1900s, which featured practices that date back centuries (see Supplement 2, Origins of the French-Intensive Method)
 - c) Popularized in the U.S. by English gardener Alan Chadwick at UC Santa Cruz, Covello, Green Gulch, and other gardens that he started
 - d) Renamed “biointensive gardening” by former Stanford Research Institute scientist John Jeavons and popularized via his *How to Grow More Vegetables* books
 - e) See also *French Intensive Gardening: A Retrospective* in Resources
2. Primary features of the French-intensive system
 - a) Deep cultivation with hand tools: Cultivation depths may be as great as 24 inches; this process distributes organic matter and mineral amendments through the soil horizons, and eventually increases topsoil depth. Deep cultivation allows for greater vertical development of crop root systems, affording higher density planting and thus higher yields per surface area of land.
 - b) Concentration of organic matter and mineral amendments into permanent growing beds: High application rates of mineral and organic matter amendments rapidly improve soil physical and chemical properties. Compost application rates may range from 10 to 20 tons/acre/year (0.5–1 pound/square foot) for maintenance purposes and up to 2 pounds/square foot for soil development purposes.
 - c) Use of fully mature particulate compost: Allows for immediate nutrient availability to crops and affords a more rapid spring turnover from cover crops to planting cash crops
 - d) Permanent growing beds and pathways: Permanent cropping areas and pathways restrict traffic and soil compaction to pathways and allow for more rapid development of soil fertility in the beds
3. Implements used in French-intensive soil cultivation (see Appendix 2, Garden-Scale Tillage and Planting Implements)
 - a) Primary cultivation tools: Spade, fork, U-bar
 - b) Applications and effects
 - i. Spade: Used in single and double digging to remove and shift soil
 - ii. Fork: Used in double digging to fracture surface and sub-soil layer; to incorporate mineral and organic matter amendments into surface soil following deep digging; to incorporate amendments into the surface of improved soils when deep cultivation is no longer necessary
 - iii. U-bar: Used for rapid and coarse tillage to 16 inches in situations where deep cultivation is no longer necessary or desired
 - c) Secondary cultivation tool: Bow rake
 - d) Applications and effects
 - i. Rake: Used to shape garden beds after primary cultivation and reduce, when necessary, the surface soil particle size in preparation for planting seeds and seedlings

4. Common tillage sequences used in French-intensive soil cultivation (see Appendix 3, French Intensive/Double-Digging Sequence)
 - a) Primary cultivation or “double digging” (for unimproved soil)
 - i. Spread compost over surface of bed at a rate of ~1 pound/square foot
 - ii. If soil is extremely compacted or on undeveloped clay soils, fracture surface soil of garden bed with garden fork to depth of tines to allow for greater ease of digging
 - iii. Remove trench of soil and put in wheelbarrow; move wheelbarrow to end of bed where the soil will be used to fill the last trench
 - iv. Shift soil forward filling trench via double-digging process using spade and digging board
 - v. Spread ~1 pound/square foot of additional organic matter and fracture sub-soil layers with garden fork
 - vi. Repeat process to end of bed
 - b) Secondary cultivation

This step occurs following primary cultivation (deep digging or double digging) of unimproved soil

 - i. Incorporate additional mineral and organic matter soil amendment into top 4–6 inches of surface soil with a garden fork
 - ii. Use a garden fork to reduce the surface soil particle size, when necessary (tilthing)
 - iii. Use a bow rake to shape garden beds after primary cultivation in preparation for transplanting or direct sowing of crops
 - c) Primary cultivation or “side forking,” a form of tilthing (for improved soil; see Appendix 4, Side Forking or Deep Forking Sequence)

Once soil has been improved through deep or double digging, raised beds can often be maintained in subsequent crop cycles through single digging or “side forking” prior to planting. If beds become compacted over time, they may require another round of deep or double digging, but over-cultivation should be avoided (see Lecture 1, E. Possible Impacts of Frequent and Intensive Soil Cultivation). To side fork a bed:

 - i. Spread mineral and organic matter soil amendments evenly onto the surface of the garden bed
 - ii. Articulate edge of bed and pathways with garden fork or spade
 - iii. Incorporate soil amendments into top 4–6 inches of surface soil with garden fork using “side forking” technique
5. Potential benefits of the French-intensive system
 - a) Rapid improvements in soil health: Improves soil physical properties, which in turn improves chemical and biological properties. French-intensive cultivation methods may rapidly increase the rate of topsoil development.
 - b) The increased ability of the soil to support cultivated plant growth at high-density spacing results in high yields per surface area of land used
 - c) Close spacing of cultivated plants creates a living mulch microclimate that reduces rates of surface evaporation and organic matter oxidation. High-density plantings reduce weed competition by shading competing plant species.
 - d) The exclusive use of hand tools reduces or eliminates the need for energy-intensive heavy machinery
6. Potential disadvantages of the French-intensive system
 - a) Requires large volume of organic matter inputs. Traditional French-intensive garden systems use, on average, up to 40 tons per acre of compost during the initial stages of soil development and 10–20 tons per acre of compost for maintenance. This poses a significant management, labor, and potential cost burden for a commercial operation.
 - b) Intensive manual labor limits scale of production. Labor-intensive nature of system is often not practical/competitive on a commercial scale.

Lecture 3: Mechanical/Field-Scale Tillage Systems & Implements

A. Mechanical/Field-Scale Tillage Systems

1. Conventional tillage
 - a) Defined: Combined primary and secondary tillage operations normally performed in preparing beds for a given crop or area
 - b) Mechanical tillage implements and operations (see Appendix 5, Field-Scale Tillage implements and Appendix 6, Tractors and Implements for Mixed Vegetable Farming Operations Based on Acreage)
 - i. Off-set disc: Primary tillage implement used to incorporate cover crop and crop residue
 - ii. Spader: Primary tillage implement used to incorporate cover crop and crop residue. Very slow speed of operation. Deep tillage (14+ inches) without soil inversion. Similar effect on soil as double digging.
 - iii. Plow: Primary tillage implement used to open soils, incorporate crop residue. Inverts soil and may create hard pan. Less commonly used in organic systems.
 - iv. Rototiller: Primary or secondary tillage implement used to incorporate crop residue. Used for seedbed preparation. Pulverizes soil and produces a fine surface texture. May degrade aggregates and create hard pan through repeated use.
 - v. Ring roller: Secondary tillage implement that is pulled behind disc or chisel to firm soil to reduce loss of soil moisture and break large soil clods. Also used to incorporate small cover crop seed. See more about ring rollers in Supplement 3, Tillage and Bed Formation Sequences for the Small Farm.
 - vi. Chisels (for sub-soiling): Primary tillage implement composed of long shanks that are pulled behind tractor to break up compacted sub-soils and allow rainfall to penetrate to greater depths
 - vii. Lister bar and bed markers: Secondary tillage equipment used to roughly shape beds following primary tillage
 - viii. Bedders/bed shapers: Used to shape beds for planting; seeders and rolling markers may be mounted to rear
 - ix. Knives and sweeps, reverse disc hillers, and furrow chisels: Close cultivation equipment used in row crops post-planting
 - x. Spring-toothed harrow: Used for light weed cultivation, soil aeration, and covering cover crop seed; brings up perennial weeds to surface
2. Minimum tillage (a.k.a. reduced, conservation, or strip tillage)
 - a) Defined: Combined primary and secondary tillage operations that use fewer operations than conventional tillage in preparing a seedbed for a given crop or area. In the West, used primarily in large-scale conventional systems (e.g., cereal crops, processing tomatoes).
 - b) Types of minimum tillage
 - i. Conservation/mulch tillage: Tillage or preparation of the soil in such a way that plant residues or other mulching materials are left on or near the soil surface to conserve soil moisture and prevent soil erosion. Used successfully by some organic growers, but usually in rotation with conventional tillage due to weed and soil fertility concerns.
 - ii. No-till and strip-till systems: Planting into a minimally prepared seed bed. Planting without tillage throughout the growing season.
 - c) Advantages
 - i. Reduces soil organic matter losses
 - ii. Reduces soil erosion rates

- iii. Conserves energy
- iv. Saves time and labor inputs
- d) Disadvantages
 - i. Less aeration and soil warming resulting in reduced mineralization rate of organic matter = reduced nutrient availability and lower yields for certain crops in cooler climates
 - ii. Strip till encourages easy access to crop by gophers, moles, etc.
 - iii. Requires increased use of herbicides or close cultivation and/or hand weeding
 - iv. Requires expensive, specific implements (drills, chisels, seeders, transplanters, cultivators) that may be prohibitively expensive or not available for smaller-scale systems
- e) Application of no-till systems
 - i. Steep slopes: Planting on slopes too steep for conventional tillage
- f) Tools and practices used in minimum tillage
 - i. Conservation tillage: Use of subsurface tillage equipment such as sub soiler or chisels to till root zone but minimally disturb surface soil
 - ii. No-till: Use of special planters that cut thorough surface trash ahead of planter
- 3. Common tillage sequences used in small-scale mechanized farming systems (spring to fall); see Supplement 3 for additional details
 - a) Primary tillage: Incorporation of cover crop residue in spring
 - i. Mow cover crop (flail or rotary)
 - ii. Apply compost with manure spreader prior to residue incorporation, if necessary
 - iii. Incorporate cover crop residue and compost with mechanical spader or offset wheel disc
 - iv. Rototill or disc field to improve surface uniformity following residue breakdown
 - b) Bed configuration/in-row spacings (see Supplement 4, Field-Scale Row Spacing)
 - i. Width of bed(s) often dictated by spacing of tractor tires
 - ii. Once bed width is determined, set lister bar and furrowing shovels to appropriate spacing
 - c) Secondary tillage: Seedbed establishment
 - i. Form beds with lister bar and shovels or rolling cultivator
 - ii. Shape bed with bed shaper
 - d) Bed planting
 - i. Plant beds with seeder, transplanter, or by hand
 - e) Cultivate planted beds with sweeps, knives, or rolling cultivator at timely intervals to minimize weed pressure (see Unit 1.10, Managing Weeds)
 - f) Incorporation of crop residue for cover cropping or fall crop planting (see also Unit 1.6, Selecting and Using Cover Crops)
 - i. Mow crop residue
 - ii. Incorporate crop residue
 - iii. Chisel or subsoil, if necessary
 - iv. Plant cover crops
 - v. Disc and roll
 - vi. Reshape and plant beds for fall cropping

Demonstration 1: Preparing the Garden Site for French-Intensive Soil Cultivation

for the instructor

INTRODUCTION

The following demonstration takes students through the steps required to assess soil moisture and prepare a site prior to creating garden beds using the French-intensive method of soil cultivation. Once the site is prepared, move on to Demonstration 2 and the accompanying Hands-on Exercise.

SITE PREPARATION AND MATERIALS

1. At the demonstration site, string and stake a well-developed garden bed (if available) and an undeveloped site to illustrate techniques used in the initial stages of soil development and those used to maintain well-developed soils. Have samples of unimproved and improved soils at the demonstration site.
2. Pre-irrigate the demonstration site soil (where necessary) in order to have the site within the optimal range of 50–75% of field capacity by the day of the demonstration. To illustrate soil moisture extremes, pre-irrigate an additional area to saturation just prior to the demonstration. Also identify soils with moisture content below 50% of field capacity. The above three examples may be used to show students how to gauge soil moisture and to illustrate the importance of tillage operations within the range of optimal soil moisture. Print out and use the USDA-NRCS publication *Estimating Soil Moisture by Feel and Appearance* as a guide for this step (see Resources).
3. Assess existing compost piles for samples of stabilized, finished compost and those at varying stages of decomposition. Use these samples to illustrate which compost to use and problems associated with incorporating undecomposed organic matter into the soil.
4. If available, standing cover crops may be used to demonstrate skimming/clearing or incorporation of cover crops into the soil with hand tools and/or the incorporation of cover crops into the trench during the double-digging process.

PREPARATION TIME

1.5 hours

DEMONSTRATION TIME

1.5 hours

DEMONSTRATION OUTLINE

A. Plan the Site Preparation with Students

1. Assess soil moisture
 - a) Soil moisture
 - i. With the students, determine the current soil moisture content (in % field capacity) of various soil samples (wet, dry, and optimal) using the soil moisture charts (see Appendix 1 and the USDA-NRCS publication *Estimating Soil Moisture by Feel and Appearance*)
 - ii. Ask student to decide which of the soil samples are within the optimal range of soil moisture for cultivation. Define optimal soil moisture range and provide example.
 - iii. List problems associated with tillage outside of this optimal range
 - iv. Look at results of or attempt to dig in soil that is too wet or too dry
 - v. Demonstrate how to adjust soil moisture when too moist or too dry
 - b) The stage of soil development
 - i. Review the influence of soil development on tillage strategies
 - ii. Discuss with students how tillage approaches may differ on: unmodified, well-developed, and degraded soils. Provide examples of each and physical indicators that students may use in determining tillage approaches.
 - iii. Discuss how a given method of cultivation may improve or degrade the existing soil structure of the examples provided
 - iv. Discuss/ask how tillage techniques may evolve and change as soil fertility develops over time
 - c) The soil texture
 - i. Have students approximate the soil texture by feel
 - ii. Tell students how and why tillage approaches may differ on: sand, silt and clay soils. Provide examples of each.
 - iii. Talk about how a given method of cultivation may improve or degrade the existing soil structure of the examples provided
 - d) Type of crop to be grown
 - i. Talk about how the seed size, transplant size, and vigor, as well as the rooting depth of crops, may influence the type of primary tillage and the degree of secondary tillage. Provide examples of crops requiring deep tillage, course secondary tillage, and those requiring a fine seedbed for optimal germination or early growth of transplants.
2. Discuss considerations for determining the quantity, quality, timing, and type of soil amendments to be applied during cultivation
 - a) What fertility amendments to apply (compost and OMRI-approved granular concentrated organic fertilizers; OMRI = materials approved by the Organic Materials Review Institute for use in certified organic systems, www.omri.org)
 - i. Discuss/review the use of laboratory soil analysis results and the resources in this manual (see Unit 1.11, Reading and Interpreting Soil Test Reports) as you identify the need for, type, and application rates of OMRI-approved granular organic fertilizers and/or organic matter amendments
 - b) How much compost to apply
 - i. Review compost quality (see Unit 1.7, Making and Using Compost)
 - ii. Discuss/ask students how application rates may differ on unmodified, well-developed, or degraded soils

- iii. Discuss/ask how application rates may change as soil fertility develops over time
- iv. Discuss the amount of compost needed to develop and maintain both physical and chemical soil properties (up to 2 pounds per square foot for development and ~0.5–1 pound per square foot for maintenance)
- v. Discuss the varying nutrient demands of specific crops (provide reference) and the question of amending soil following each cropping sequence
- c) Where to apply and incorporate soil amendments
 - i. Discuss/ask how the placement and distribution of amendments may change as soil fertility develops over time

B. Demonstrate Site Preparations

1. Removal and storage of cover crops, crop residue, and weed cover
 - a) Demonstrate skimming techniques used to remove and store cover crops and/or crop residues
2. Bed layout
 - a) Demonstrate and discuss garden bed layout by staking and stringing a garden bed with students. Note: Emphasize the importance of soil amendments and tillage techniques always being evenly applied to the entire marked area; garden bed delineation (stringing) serves as a visual guide in this process.

Demonstration 1: Preparing the Garden Site for French-Intensive Soil Cultivation

step-by-step instructions for students

INTRODUCTION

A key component to developing and maintaining fertile garden soil is the proper use of tillage and soil amendments. The following step-by-step instructions will guide you through site assessment and preparation steps to take prior to French-intensive tillage operations or “double digging.” In Demonstration 2 you will prepare the French-intensive raised beds.

PREPARATION AND MATERIALS

- Soil moisture chart (Appendix 1 and the USDA-NRCS publication *Estimating Soil Moisture by Feel and Appearance*)
- Tools: Garden spade and fork, U-bar/broad fork, stakes and string, wheelbarrow or buckets, tape measure, digging board, bow rake
- Any needed amendments (mineral amendments, soy meal, fish meal, etc.)
- Stabilized, mature compost

Collect and organize the materials listed above.

DEMONSTRATION OUTLINE

A. Cultivation Planning

1. Assess soil prior to cultivation
 - a) Soil moisture
 - i. Assess the current soil moisture content using the soil moisture chart
 - ii. The optimal range of soil moisture for cultivation is between 50–75% of field capacity. If soil moisture is <50% of field capacity, pre-irrigate, bringing the top 24 inches of soil to field capacity. Wait for the soil moisture to fall within the optimal range, then till as described in Demonstration 2.
 - b) The stage of soil development/soil fertility
 - i. Undeveloped, compacted soils or those indicating the need for significant additions of organic matter or corrections to soil chemistry should receive a thorough double digging, during which soil amendments are incorporated throughout the soil profile
 - ii. Loose and friable soils with well-developed soil aggregations, adequate organic matter and mineral amendments, and no nutrient imbalances or organic matter deficiencies (as indicated by the soil test) may be prepared using a deep forking technique where soil amendments needed for soil fertility maintenance are incorporated into the top 4–6 inches of topsoil
 - c) The soil texture
 - i. What is the soil texture? If unknown, use the exercise in Unit 2.1, Soil Physical Properties, to determine the soil texture.
 - ii. Soils with a high clay content often require the long-term application of deep tillage to improve the physical and biological properties of the soil. The physical properties of sandy soils are both more rapidly improved and degraded by extensive tillage and should be tilled shallowly, using the deep forking method, once improved.
 - d) Type of crop to be grown
 - i. Secondary tillage techniques should be used to render the surface soil particle size in proper proportion to the size of the transplant or seed being sown
 - Directly seeded crops and small, weak, or inefficiently rooted transplants require a fine surface soil particle size
 - Large, vigorous transplants may be transplanted into a more coarsely tilled soil
2. Determine need for the application of soil amendments during cultivation
 - a) Mineral amendments
 - i. Review laboratory soil analysis results for nutrient deficiencies or imbalances. Select mineral amendments and application rates as needed based on lab recommendations.
 - b) Compost
 - i. Thoroughly decomposed compost should be applied at a rate of 2 pounds per square foot during the initial stages of soil development and 0.5–1 pound* per square foot per year to maintain physical and chemical soil properties (*this amount will vary depending on intensity and types of crops grown)
3. Apply and incorporate soil amendments (when necessary)
 - a) Initial stages of soil development: Organic matter and mineral amendments are often applied both to the surface of the soil (prior to tillage) and to the exposed sub-soil during the deep tillage process. Additional compost is incorporated into the top 4–6 inches of the surface soil using the deep forking technique, helping to assure immediate plant nutrient availability.

- b) Well-developed soils: Soils indicating no nutrient deficiencies or significant chemical imbalances often require only periodic deep tillage. Maintenance applications of compost or mineral amendments in such soils proceed by incorporating amendments into the top 4–6 inches of the surface soil, thereby assuring the availability of essential plant nutrient in the root zone of the crop.

B. Soil Cultivation Preparations

1. Remove and properly store cover crops, crop residue, or weed cover
 - a) Removal
 - i. With a spade, skim standing vegetation at soil surface
 - ii. Root systems of cover crops, crop residue, and weed cover may be removed during the cultivation process
 - b) Storage
 - i. All succulent, green vegetation should be removed and stored at the composting site
2. Lay out garden bed
 - a) Staking
 - i. Mark the four corners of the bed with stakes pounded firmly into ground
 - ii. French-intensive beds are commonly 48 inches wide or two times the length of the gardener's arm, allowing for ease of access to center of the bed for weeding, harvesting, etc.
 - b) Stringing
 - i. Stretch string along the length of the growing bed to serve as a visual guide. Soil amendments and cultivation techniques should always be consistently and evenly applied to this entire area.

The site is now ready for cultivation, as described in Demonstration 2 and the Hands-on Exercise

Demonstration 2: French-Intensive Soil Cultivation

for the instructor

OVERVIEW

The following demonstration introduces the practice of the French-intensive method of soil cultivation. Following this demonstration and with the help of step-by-step instructions, students will be asked to prepare a garden bed using French-intensive tillage techniques.

SITE PREPARATION AND MATERIALS

1. Following Demonstration 1, you should have garden beds staked and marked out with string, at proper soil moisture, and ready for cultivation.
2. In advance of the demonstration, divide the pre-existing garden bed into four* 6-foot sections (*may be more or less depending upon number of techniques to be modeled). In the front 3 feet of each 6-foot section, pre-till sample sections using the following tools and techniques: double digging, single digging, deep forking, U-bar/broad fork. Pre-tilled examples may be used to illustrate both the effects on the soil of the individual techniques and to compare/contrast effects of different techniques. The remaining 3-foot sections of untilled soil may be used to demonstrate each of the techniques listed above.
3. On the day of the demonstration, gather tools, materials, and handouts: spade, garden fork, u-bar/broad fork, digging board, granular soil amendments, finished compost/aged manure, the soil moisture chart (Appendix 1), and the USDA-NRCS publication *Estimating Soil Moisture by Feel and Appearance* (see Resources)

PREPARATION TIME

1 hours

DEMONSTRATION TIME

1.5 hours

DEMONSTRATION OUTLINE

A. Demonstrate Proper Tool Techniques for Outcome, Safety, and Efficiency

1. Discuss tools used and why
2. Demonstrate proper use of each tool
3. Discuss importance of proper digging technique to prevent injury

B. Demonstrate and Discuss Primary Cultivation Steps

1. Double digging (primary cultivation for unimproved soils)
 - a) Step 1: Spread organic matter and mineral amendments evenly over surface of garden bed
 - b) Step 2: Articulate edges of bed with a garden fork
 - c) Step 3: If the soil is compacted or high in clay, fracture and loosen surface soil with garden fork
 - d) Step 4: Use a spade to create first trench across the width of the bed. Soil storage.
 - e) Step 5: Add additional compost on the bottom of the trench
 - f) Step 6: Fracture and loosen the subsoil in the bottom of the trench
 - g) Step 7: Use a digging board as a fulcrum and spade to shift the surface soil forward in order to stir soil, incorporate amendments and create the second trench
 - h) Repeat steps 5–7 along the length of the bed
 - i) Step 8: Replace soil removed from first trench in the last trench
 - j) Step 9: Incorporate additional soil amendments into the top 4–6 inches of the surface soil using the “Deep Forking/Side Forking” steps (see below)
 - k) Discuss/ask students under which circumstances the above technique is used
 - i. The use of secondary tillage techniques
 - ii. Discuss/ask students about the probable effects on soil organisms, root activity, water movement/retention, gas exchange, temperature, etc.
2. Deep forking or side forking (primary cultivation for improved soils)
 - a) Step 1: Spread organic matter and mineral amendments
 - b) Step 2: Articulate edges of bed with a garden fork
 - c) Step 3: Fracture and loosen surface soil with garden fork
 - d) Step 4: Sift the soil with garden fork to incorporate soil amendments into the top 4–6 inches of the soil surface (see Appendix 4, Side Forking or Deep Forking Sequence)
 - e) Discuss/ask student under which circumstances the above technique is used

C. Demonstrate and Discuss Secondary Cultivation Steps

1. Step 1: Sift the soil with garden fork to incorporate soil amendments into the top 4–6 inches of the surface soil
2. Step 2: Use the bow rake to shape the surface of the recently tilled bed into a flat or slightly convex form
3. Step 3: Fracture large soil clusters with fork or rake to reduce surface soil particle size in proper proportion to the size of the seed or transplant to be grown
4. Step 4: Use the leaf rake to remove large soil clusters resistant to fracturing
5. Discuss/ask students under which circumstances is the above technique used

D. Discuss Evaluation Process

1. Has there been consistent and optimal soil moisture throughout the cultivated area? If not, how might this be addressed?
2. Has the tillage been thorough and even in depth and width?
3. Have the soil amendments been thoroughly and evenly incorporated?
4. Effects on the physical properties of the soil: Discuss/ask students how have these properties have been altered by this tillage technique or tillage sequence. How might these techniques affect the biological activity and nutrient cycling in the soil? How might they affect plant growth?
5. Discuss improvements in efficiencies that could be made

Demonstration 2: French-Intensive Soil Cultivation

step-by-step instructions for students

INTRODUCTION

A key component to developing and maintaining fertile garden soil is the proper use of tillage and soil amendments. The following step-by-step instructions will guide you through the execution, and evaluation of French-intensive tillage operations. Follow the steps outlined below when developing and maintaining French-intensive raised beds. Note that the site preparation for this exercise is done in Demonstration 1.

PREPARATION AND MATERIALS

- Soil moisture chart (Appendix 1) and USDA publication *Estimating Soil Moisture by Feel and Appearance*
- Tools: Garden spade and fork, U-bar/broad fork, stakes and string, wheelbarrow or buckets, tape measure, digging board, bow or leaf rake
- Any needed mineral amendments
- Stabilized compost

Collect and organize the materials listed above.

A. Proper Tool Techniques for Outcome, Safety, and Efficiency

1. Assemble needed tools and materials
2. Review proper tool techniques for outcome, safety, and efficiency
 - a) Warm up before working with movement and stretching
 - b) Use tools and techniques that allow you to keep your back straight at all times when working
 - c) Use tools to shift soil not lift soil (see below)
 - d) When lifting, use only your legs and not your back muscles
 - e) Always wear closed-toed shoes when working

B. Primary Cultivation Steps

1. Double digging (primary cultivation for unimproved soils; see Appendix 3, French Intensive/Double-Digging Sequence)
 - a) Step 1: Spread needed organic matter and mineral amendments evenly over soil surface
 - b) Step 2: Using string line as guide, articulate edges of bed with a garden fork
 - c) Step 3: Fracture and loosen surface soil with garden fork to the depth of the tines
 - d) Step 4: Using a spade, create a trench 1 foot deep by 1 foot wide across the width of the bed. Place this soil in wheelbarrow or buckets and set aside.
 - e) Step 5: Spread additional compost on the bottom of the trench
 - f) Step 6: Standing on the path or on a digging board and working from the center of the garden bed outward, fracture and loosen the soil in the bottom of the trench. Repeat this process on both sides of the bed.
 - g) Step 7: Using a digging board as a fulcrum, shift the surface soil forward filling the first trench, creating a second trench 1 foot deep and 1 foot wide
 - h) Repeat Steps 5–7 along the length of the bed until you reach the end of the bed
 - i) Step 8: Place soil removed from first trench into the last trench created
 - j) Step 9: Using a garden fork, incorporate additional soil amendments needed into the top 4–6 inches of the surface soil (see “Deep forking” steps 1–4, below)
2. Deep forking or side forking (primary cultivation for improved soils; see Appendix 4, Side Forking or Deep Forking Sequence)
 - a) Step 1: Spread needed organic matter and mineral amendments evenly on soil surface
 - b) Step 2: Using string line as guide, articulate edges of bed with a garden fork
 - c) Step 3: Working from the center of the garden bed outward, fracture and loosen large surface soil clusters with garden fork to the depth of the tines. (This will permit greater ease of digging in subsequent tillage steps.)
 - d) Step 4: Using a garden fork and working from the center of the garden bed outward toward the pathway, force garden fork into soil to the depth of the tines. Scoop and lift soil above soil surface and with a gentle jerking motion allow soil and compost to fall and sift through the tines of the fork (see Appendix 4).
3. Alternative cultivation tools: Advantages and disadvantages
 - a) U-bar/broad fork
 - b) Rototiller
 - c) Others

C. Secondary Cultivation Steps

1. Step 1: Sift the soil with garden fork to incorporate soil amendments into the top 4–6 inches of the surface soil
2. Step 2: Use the bow rake to shape the surface of the recently tilled bed into a flat or slightly convex form
3. Step 3: Fracture large soil clusters with fork or rake to reduce surface soil particle size in proper proportion to the size of the seed or transplant to be grown
4. Step 4: Use the bow rake to remove large soil clusters resistant to fracturing
5. Under which circumstances is the above technique used?

D. Evaluation

1. Have all of the soil amendments been thoroughly incorporated into the soil?
2. Has the entire garden bed been thoroughly and evenly tilled in depth, width, and length?
3. How have the physical, chemical, and/or biological properties of the soil been altered by this tillage?
4. How might one improve the efficiency of this process?

Hands-On Exercise: French-Intensive Soil Cultivation

for the student

The following tillage exercise will help you develop the skills needed to cultivate and maintain traditional French-intensive raised garden beds. In this exercise you will be asked to evaluate distinct soils—both unimproved and improved—for their tillage needs and, from start to finish, execute the necessary steps to develop soils for horticultural purposes. Please document the rationale for each tool, technique, and sequence used during this exercise. This information will later be shared with your instructor. During the exercise your instructor should observe and critique your tillage skills.

PREPARATION AND MATERIALS

- Step-by-step instruction sheet (pp. 57–59, Demonstration 2)
- Soil moisture chart
- Tools: Spade, fork, or U-bar; stakes and string, wheelbarrow, tape measure
- Stabilized compost

EXERCISE

Document the rationale for each tool, technique, and sequence used during each of the following tasks:

- Prepare 10 feet of unimproved garden soil using necessary soil improvement techniques
- Prepare 25 feet of an improved garden bed using necessary soil maintenance techniques

Demonstration 3: Field Demonstration of Mechanical Tillage & Cultivation

for the instructor

OVERVIEW

For this field demonstration the instructor should have access to a wide range of tractor-mounted or drawn tillage and cultivating implements and the appropriate tractors for each of the implements. The demonstration also requires access to tillable land and existing diverse cropping systems and/or formed fallow beds spaced to match the equipment.

PREPARATION AND MATERIALS

The implements and tractors should be set up adjacent to the demonstration site and parked to allow fast hook up and drop off.

PREPARATION TIME

1 hour

DEMONSTRATION TIME

1.5 hours

DEMONSTRATION OUTLINE

A. Demonstration of Primary Tillage Implements

1. Evaluate soil moisture with students and assess whether it is appropriate for tillage
2. Do field demonstration of mechanical spader
 - a) Explain fundamentals of 3 point hitch
 - b) Explain fundamentals of PTO (power take off)
 - c) Discuss ground speed, working depth, and advantages/disadvantages of spaders in contrast to other primary tillage implements
 - d) Examine soil condition, depth of tillage, and residue incorporation behind spader
3. Do field demonstration of offset wheel disc and roller
 - a) Explain fundamentals of drawbar implements
 - b) Explain fundamentals of auxillary hydraulic systems
 - c) Discuss ground speed, traction requirements, working depth, and advantages/disadvantages of discs in contrast to other primary tillage implements
 - d) Examine soil condition, depth of tillage, and residue incorporation behind disc
4. Examine 3 point chisel
 - a) Explain use of chisels
 - b) Discuss working depths, soil moisture requirements, traction requirements, and advantages/disadvantages of chisels in contrast to other primary tillage implements.

B. Demonstration of Secondary Tillage Implements

1. Do a field demonstration of a rotovator (3 point rototiller)
 - a) Explain the use of rotovators
 - b) Discuss ground speed, working depth, and advantages/disadvantages of rotovators in contrast to other secondary tillage implements
2. Examine spring tooth harrow
 - a) Explain use of harrows
 - b) Discuss working depths and advantages/disadvantages of spring tooth harrows in contrast to other secondary tillage implements

C. Demonstration of Bed Forming and Shaping Implements

1. Examine furrowing shovels and rolling cultivator
 - a) Explain the use of furrowing shovels and rolling cultivators for bed formation
 - b) Demonstrate methods for forming straight beds (following wheel tracks / using guidance)
 - c) Demonstrate the use of a rolling cultivator for bed forming
 - d) Demonstrate the use of a bed shaper

D. Demonstration of cultivators

1. Do a field demonstration of rolling cultivator
 - a) Run rolling cultivator down fallow beds
 - b) Discuss the various uses of the rolling cultivators for weed management in fallow and cropped systems
2. Do a field demonstration of row crop cultivator set up with sweeps and knives
 - a) Run cultivator down crop row
 - b) Discuss the various components of cultivator operation and set up

Assessment Questions Key

- 1) List four objectives of soil tillage.
 - *Increase soil aeration*
 - *Increase soil temperature*
 - *Increase gas exchange*
 - *Stimulate soil biological activity/ increase rate of mineralization*
 - *Improve drainage characteristics: Infiltration and percolation*
 - *Incorporate soil amendments*
 - *Control of pests and diseases*
 - *Break up hard pans*
 - *Incorporate crop residue and/or cover crops*
 - *Create planting bed for transplants and seeds*
 - *Soil moisture conservation*
- 2) What are two possible problems associated with tilling soil when it is too wet or too dry?
 - *Soil compaction (the compression of pore space)*
 - *Soil pulverization (the degradation of soil aggregates)*
 - *Difficult to work*
- 3) What is the optimal range of soil moisture (in % field capacity) for tillage operations?
 - *Between 50% and 75% of field capacity*
- 4) What are you attempting to achieve through the double-digging process? In what situations is this technique best applied?
 - *Stimulation of biological activity and diversity through organic matter inputs*
 - *The rapid improvement of soil physical properties through soil aeration and the alleviation of compacted soil*
 - *The rapid improvement of soil chemical properties through deep incorporation of generous amounts of organic matter and mineral amendments*
 - *Used during the initial stages of soil development*
- 5) What are the common tillage sequences used in preparing ground in the spring? Please give steps for both French-intensive (double digging) and mechanical cultivation.
 - *Double digging*
 - a) *Step 1: Spread needed organic matter and mineral amendments evenly over soil surface*
 - b) *Step 2: Using string line as guide, articulate edges of bed with a garden fork*
 - c) *Step 3: Fracture and loosen surface soil with garden fork to the depth of the tines*
 - d) *Step 4: Using a spade, create a trench 1 foot deep by 1 foot wide across the width of the bed. Place this soil in wheelbarrow or buckets and set aside.*
 - e) *Step 5: Spread additional compost on the bottom of the trench*
 - f) *Step 6: Standing on the path and working from the center of the garden bed outward, fracture and loosen the soil in the bottom of the trench. Repeat this process on both sides of the bed.*
 - g) *Step 7: Using a digging board as a fulcrum, shift the surface soil forward filling the first trench, creating a second trench 1 foot deep and 1 foot wide.*
 - h) *Repeat Steps 5–7 along the length of the bed until the end of the bed is reached*
 - i) *Step 8: Place soil removed from first trench into the last trench created*
 - j) *Step 9: Using a garden fork, incorporate additional soil amendments needed into the top 4–6 inches of the surface soil*
 - *Mechanical cultivation*
 - a) *Primary tillage: Incorporation of cover crop residue in spring*
 - i. *Mowing (flail or rotary)*
 - ii. *Apply compost with manure spreader prior to residue incorporation, if necessary*

- iii. Incorporate cover crop residue and compost with spader or off-set wheel disc*
 - iv. Rototill or disc field to improve surface uniformity following residue breakdown*
 - b) Secondary tillage: Seedbed establishment*
 - i. Form beds with lister bar and shovels or rolling cultivator*
 - ii. Shape bed with bed shaper*
 - c) Bed formation and planting*
 - i. Plant beds with seeder, transplanter, or by hand*
 - d) Cultivate planted beds with sweeps, knives, or rolling cultivator at timely intervals to minimize weed pressure*
 - e) Incorporation of crop residue*
 - i. Mow crop residue*
 - ii. Incorporate crop residue*
 - iii. Chisel or subsoil, if necessary*
 - iv. Disc and roll*
 - v. Reshape and plant beds*

Resources

PRINT RESOURCES

Fortier, Jean-Martin. 2014. *The Market Gardener: A Successful Grower's Handbook for Small-Scale Organic Farming*. Gabriola Island, British Columbia: New Society Publishers.

Includes a section on permanent raised beds, tillage equipment for small-scale production, and minimum tillage.

Grubinger, Vernon. 1999. *Sustainable Vegetable Growing from Start-Up to Market*. Ithaca, NY: Natural Resource, Agriculture, and Engineering Service.

Includes a section on tillage equipment and field preparation.

Jeavons, John. 2012. *How To Grow More Vegetables, Fruits, Nuts, Berries, Grains, and Other Crops Than You Ever Thought Possible on Less Land Than You Can Imagine, Eighth Edition*. Berkeley, CA: Ten Speed Press.

An overview of the French-intensive, biodynamic method of horticulture, with information on cultivation and bed preparation.

Martin, Orin. 2007. French-Intensive Gardening: A Retrospective. *News & Notes of the UCSC Farm & Garden*, Winter 2007. Center for Agroecology & Sustainable Food Systems.

Summarizes the history and practice of French-intensive organic gardening, as introduced by Alan Chadwick at UC Santa Cruz and in use today at UCSC's Alan Chadwick Garden. Available for free download from casfs.ucsc.edu/about/publications/for_the_gardener.html

Plaster, Edward. 2014. *Soil Science and Management, 6th Edition*. Delmar Publications.

Contains a chapter on tillage and cropping systems.

Pressman, Andy. 2011. *Equipment and Tools for Small-Scale Intensive Crop Production*. NCAT Publication #IP417.

Focuses on equipment and tools for intensive crop production on small-scale commercial farms. Includes information on field-scale and hand tools used for soil preparation, planting

and weed management, and an extensive list of tool suppliers. Available for online purchase at: attra.ncat.org/attra-pub/summaries/summary.php?pub=373

WEB-BASED RESOURCES

ATTRA, National Sustainable Agriculture Service
attra.ncat.org

ATTRA provides a wide range of free and low-cost resources, including publications on organic farming, field crops, horticultural crops, and resources for beginning farmers.

Agricultural Network Information Collaborative
www.agnic.org/

AgNIC is a guide to quality agricultural information on the Internet as selected by the National Agricultural Library, Land-Grant Universities, and other institutions.

Estimating Soil Moisture by Feel and Appearance, USDA NRCS Program Aid Number 1619

www.nrcs.usda.gov/wps/portal/nrcs/detail/mt/newsroom/?cid=nrcs144p2_056492

www.ext.colostate.edu/sam/moisture.pdf

This user-friendly guide describes how to use the “feel and appearance” method to estimate soil moisture. Includes photos of a range of soils at various moisture levels and provides useful guidelines for estimating soil moisture conditions, e.g., by using the “squeeze test.”

Good Fruit Grower

www.goodfruit.com/buyersguide/

Includes a listing of national equipment retailers.

Institute of Agriculture and Natural Resources, University of Nebraska-Lincoln

cropwatch.unl.edu/tillage

Tillage system descriptions and comparisons.

Rodale Institute—Organic No-Till

rodaleinstitute.org/our-work/organic-no-till/

Describes the Rodale Institute's work on organic no-till cropping systems.

SUPPLEMENT 1

Goals of Soil Cultivation

Cultivation is a purposefully broader concept than simply digging or tilling the soil—it is a process toward optimum fertility. It encompasses a broad array of tools, materials, and methods. In the French-intensive approach to gardening it usually involves single and/or double digging. This supplement reviews the goals of cultivation.

By definition, cultivation is derived from *cultivate* (verb) from the Latin, *colo, cult* = to till, worship.

To cultivate means to –

- improve or prepare the soil for raising of crops
- grow or tend a plant or crop (hoeing, weeding)
- form or refine as by education
- cherish, or seek the acquaintance or goodwill of
- nourish

All of the above definitions apply in regards to soil cultivation, appreciation, and stewardship.

Regardless of the scale or style of working the soil you choose, there are some fundamental concepts and goals of which to be cognizant.

Promoting Good Tilth and Structure

The main objective of cultivation is to promote and maintain good tilth. Tilth is a composite term for the overall physical characteristics of a soil (texture, structure, permeability, consistence, drainage, and water-holding capacity). In short, tilth equals the workability of a soil in relationship to its ability to grow plants, as in “this soil has good tilth!” The fork used in breaking up soil clods is a tilthing fork; the act of shattering clods is tilthing.

Regardless of soil textural class (sand, silt, or clay), one of the aims of cultivation is to develop good soil structure, with stable soil aggregates. Primary cultivation (rough digging or plowing) can aid in beginning the process of cementing soil separates together into aggregates. Limited and timely primary cultivation promotes aggregate formation.

Almost any action that shifts soil particles back and forth and forces contact will foster aggregation. Other natural forces that aid aggregation include but are not limited to –

■ Plant roots, which compress soil particles into small aggregates and break apart large clods. Organic slimy exudates from the fine root hairs cement soil particles together.

■ The alternating effects of both wetting and drying and freezing and thawing assist in aggregation.

■ Natural cultivators such as gophers, earthworms, sow bugs, millipedes, and centipedes have a mixing and cementing effect on soil separates.

In contrast, secondary cultivation—breaking up a soil to create a particulate seed bed—can have a destructive effect on soil aggregates and should be done carefully.

Preventing or Breaking Up Hard Pans

Deep cultivation, such as double digging, can physically fracture or break up impervious soil layers or “pans.” This allows better and deeper aeration, improved drainage, and deeper root penetration. The penetrating, fracturing action of both wild and cultivated crops’ roots can also be a partial antidote to pans.

Pans, be they hard, cow, or plough induced, can occur for various reasons:

■ Physical compaction created by animal, foot, or machine traffic (plough pan) can compact both surface and subsoil layers of soil. This is more pronounced on clay and if a soil is worked when wet (>50–75% of field capacity). The weight of a tractor, the number of passes and the speed and type of tines pulled behind play a hand in the compaction imparted to a soil.

Probably the most destructive yet alluring cultivation tool is the rototiller. On the plus side, it renders up a perfect, particulate seed bed. On the negative side, the high number of tines and the rapid speed of rotation, coupled with a constant scraping action at 6–8” deep, damage or destroy soil structure and rapidly create a hard pan. Rototillers also tend to kill earthworms. The spade and fork, skillfully manipulated, offer minimum compaction but obviously limit the scale of cultivation possible.

■ As a result of rainfall and irrigation, the fine particles of clay in a soil leach downward over time (and along with them nutrients, especially nitrogen and potassium). At some point they accumulate, forming an impervious natural clay pan. Soils with high clay content in areas with high annual precipitation are subject to clay pans.

■ Clay pans also occur in areas where soil is formed and deposited in layers over time, such as alluvial flood plains and valley bottoms.

It is important to dig a soil profile (3–5 feet deep) and examine and evaluate a soil before embarking on a cultivation and fertility plan.

Promoting and Maintaining Good Aeration

Cultivation increases pore space, especially macropores. Macropores drain quickly after a rain or irrigation, allowing air to re-enter a soil. In fact the raising of a bed via digging is primarily accomplished by adding air to the soil volume (keep in mind that this “loft” is temporary). Aeration is necessary to allow diffusion (a passive process) of atmospheric air into the soil and to allow excess CO₂ to exit the soil. Because of the aerobic respiration of soil microbes and plant roots, soil oxygen is significantly lower and the CO₂ is higher than that of atmospheric air: soil air can contain up to 100 times the .035% CO₂ in the atmosphere. Adequate pore space and a continuous system of pores (from the surface to the subsoil) allow a soil to “breathe.”

Constant and excess moisture also limits the re-entry of air into the soil. Keep in mind that all components of soil air are important for plant and microbial growth:

Nitrogen (N) – Soil and root bacteria in association with legumes (peas, beans, clovers, vetches, etc.) can use atmospheric nitrogen gas to produce a combined form of nitrogen (nitrate or ammonia) that roots can assimilate.

Carbon dioxide (CO₂) – Water dissolves small amounts of CO₂ given off by roots and microbial respiration to form a weak carbonic acid. This carbonic acid slowly dissolves minerals so they are more available to plants in solution over a period of years.

Oxygen (O₂) – O₂ is often the most overlooked, yet most important constituent of soil air. Adequate oxygen is essential in a soil, as all parts of plants respire/breathe: fruit, seed, stem, leaf and roots. Soil microbes also require oxygen in order to flourish: 80–90% of the beneficial microbes exist in the top 6–8 inches of the soil, where aeration and warmth

are optimal. If you use cultivation practices to extend downward the conditions of the top 6–8 inches, you exponentially increase the area where microbes grow.

Respiration is a process by which carbohydrates made by photosynthesis are converted into energy for work. Just as humans need energy for bodily functions, so do plants and microbes. The better and deeper the soil aeration, the less energy is expended by plant roots to push through the soil to get air, water, and nutrients, which translates to quicker and more vigorous subsequent growth and maturation.

Plants’ needs for air, water, and nutrients are best met when the soil has a continuous system of large- and intermediate-size pores from the surface to the subsoil through which water can enter, infiltrate, percolate, and drain while soil air is constantly being replenished from the atmosphere. This set of circumstances is optimized when proper cultivation practices are coupled with the addition of organic matter to create a granular or crumb structure. Keep in mind that roots don’t grow in soil but in the interstitial spaces between soil solids—the pore spaces.

Warming and Drying Soil

A dry soil warms more quickly than a wet one, principally because the amount of energy required to raise the temperature of water is much greater than that required to warm soil solids and soil air.

Additionally, on poorly aerated soils, if water can’t drain freely it takes a large amount of energy to evaporate the moisture via solar radiation. On average, temperate zone soils are 3–6° warmer in the spring if well drained. Cultivation—along with building and maintaining good structure—warms a soil quickly.

Reactions (biological and chemical) happen faster at higher temperatures. Thus the decomposition of organic matter by microbes, as well as water and nutrient uptake by plants, happen more quickly as soil warms: 50–55°F is a threshold figure above which there is noticeable growth, and below which growth is negligible.

Incorporating Organic Matter

Cultivation is a practical means to incorporate organic matter and fertilizers into a soil at various depths.

While all organic matter is originally derived from plant tissues, animals (micro- and macro-organisms in the soil), and animal manures

(composted alone or with plant material) are a secondary and valuable source of organic matter. The decomposed remains of microorganisms can contribute up to 20% of the total organic matter content of biologically active soils. Green manures, crop residues (roots as well as tops) and weeds, as well as intentional grass/legume cover crops incorporated into soils on a regular basis serve as fundamental building blocks of organic matter and plant nutrition (fertilizer).

Organic matter is a major force in the formation and stabilization of granular or crumb structure of soil aggregates (think of a cross section of a loaf of freshly baked whole wheat bread as a visual analogy). When organic matter is added to a soil via cultivation, the plant residues cement or bind soil particles together as a result of gels, gums, and glues that are byproducts of decomposition. Mycelial strands or webs of fungi also bind soil particles together.

Controlling Weeds

Cultivation (digging) is a practical means to knock down annual weeds and to weaken the crowns, rhizomes, etc. of pernicious perennial weed species. Note: This is a bit of a vicious cycle in that stirring the soil via cultivation also stimulates the germination of weed seeds in the soil bank.

Creating an Appropriately Well-tilthed Particulate Seed Bed

Surface tilth (particle size) should be appropriate to that which is being grown: fine seeds (carrots, poppies, etc.) need a fine seed bed. Bigger seeds (beans, peas, corn, etc.) require moderate tilth. Similarly there are smaller (lettuce, brassicas) and larger (tomatoes, squashes, peppers) transplants with their requisite surface tilth needs. Creating the appropriate surface tilth is achieved by secondary cultivation tools (fork and rake) and techniques (tilthing and raking). Use restraint when creating the seedbed; if done too often and to an extreme degree such actions destroys soil aggregates.

A Word Regarding Texture and Structure—Soil's Two Most Fundamental Physical Properties

Soil texture is a given. A clay is a clay, a sand a sand. Only on a small scale, such as with propagation and potting mixes, can you create a soil with the textural qualities required by mixing proportions of sand, soil, compost, peat, etc.; otherwise it is almost volumetrically impossible to add enough clay to a sandy soil (or vice versa) to alter texture.

An undesirable result of adding clay to sand or sand to clay is that the particles of clay and sand tend to separate and the clay surrounds and seals off the sand. This arrangement of segregated soil particles wreaks havoc with air and water movement and will turn your plant roots bipolar—they penetrate easily through the sandy pockets and slow down considerably in the clay zones.

Unlike texture, soil structure can be managed—either improved or degraded. Unfortunately the hard work and results of good practices that take years, even decades, to “come a cropper” can be lost in a few short seasons with poor practices. Things that improve structure (the opposite actions degrade structure) –

- Digging at the proper time intervals and soil moisture (50–75% of field capacity).

- Minimizing compaction (foot, animal, and machine traffic). Sandy soils are more forgiving than clay as per these first two points

- Adding organic matter frequently. Immature green manures serve more as a fertilizer, while mature cover crops (with a higher percent of carbon) improve both the organic matter content and structure of a soil.

- Proper irrigation practices. Basically, smaller droplets and lower amounts applied per time are less destructive of structure. A heavy application of water (irrigation or rain) tends to break down aggregates. The individual particles of clay disperse and seal off the surface, resulting in crusting, puddling, runoff, erosion, and the creation of massive structure, i.e., clods.

- The binding, cementing effects of plant roots and microbial exudates.

- No bare soil—either a living or dead mulch to protect surface structure. For every time water doubles its velocity it squares its erosive potential. Mulching softens and slows the speed of water.

SUPPLEMENT 2

Origins of the French-Intensive Method

The term “French-intensive method” taught in this unit is named after the market gardens on the outskirts of Paris that reached their peaks in the 19th and early 20th centuries. The cultivation, soil amendment, and water conservation practices of this method date centuries earlier; they represent techniques developed by a number of cultures and continue to be used in diverse small-scale agricultural settings worldwide.

The Parisian market gardens for which the practice was originally named were small plots of land that were deeply and attentively cultivated by French gardeners, or “maraîchers.” The “marais” system, as it is known in French, was formed in part as a response to the increasing urbanization of Paris, the attendant increase in the cost of urban land, and the ready availability of horse manure as a fertility source. English master gardener Alan Chadwick popularized both the term and the gardening method in the U.S. when he introduced them at UC Santa Cruz’s Student Garden Project (now the Alan Chadwick Garden) in 1967, and they have served as the theoretical foundation supporting the cultivation methods used at the UCSC Farm & Garden ever since.

But as Chadwick was quick to point out, other societies were using similar practices far earlier than the Parisian market gardeners. He acknowledged the influence of early Chinese, Greek, and Roman agriculture specifically, on the development of the French-intensive method. The concept of small farms dedicated to intensive cultivation of the land, improved soil fertility, water conservation, and closed-loop systems was a feature common to many early civilizations and, in fact, characterizes the majority of agriculture today in developing countries where these techniques have been passed down to successive generations.

Of the world’s 525 million farms, approximately 85% are fewer than 4 acres in size, tended to mostly by poor farmers in China, India, and Africa,¹ where methods often reflect the same philosophies of stewardship and cultivation that inform the French-intensive method we use today. In fact, small-scale agriculture represents the global history of agriculture up until the Industrial Revolution in the 18th

century. And in much of the developing world, locally adapted traditions continue to shape the way agriculture is practiced. This supplement examines some of the methods used by farmers around the world, past and present, reflecting the principles on which the French-intensive method is based.

Soil Fertility Management

As part of one of the oldest agriculture-based societies in the world, Chinese farmers have succeeded in maintaining fertile soils for thousands of years. Prior to the availability and use of synthetic fertilizers, one method Chinese farmers commonly used to maintain their soil’s fertility was to apply human waste to their fields, thereby returning large quantities of potassium, phosphorous, and nitrogen lost through harvest back to the soil. Applying this source of fertilizer, also called “night soil,” achieved many of the goals we aspire to in a French-intensive system. Recycling waste minimized external inputs and helped “close the system” by relying on a renewable, readily available source of fertilizer. High in organic matter, night soil also provided the necessary nutrients for growing successive crops on the same land without depleting the soil. Waste, both human and animal, served as the major source of fertility amendments that helped to build soil ecology and microbial activity.

Compost Production and Use

In Japan, compost production has been tied to small-scale farming for centuries. Farmers harvested herbaceous growth from nearby hillsides as a source of compost material. Compost houses were built and filled with this herbage, manure, and soil daily until piles reached five feet high. Water was constantly added to ensure saturation. Once the designated height was reached farmers let the piles sit five

¹ www.globalagriculture.org/report-topics/industrial-agriculture-and-small-scale-farming.html

weeks in summer and seven weeks in winter before turning them to the other side of the house. The compost was then applied to dryland cereal crops in spring. A study conducted in the early 20th century found that nitrogen, phosphorus, and potassium were replenished by this composting system nearly at the level lost through harvest.²

Intercropping

Intercropping, another feature of French Intensive gardening,³ is a system of growing multiple crops together in the same bed or field. Intercropping is a common feature of indigenous agriculture around the world, including the famous “three sisters” planting of corn, beans, and squash originating from Mesoamerica. Extending the growing season while maximizing land use was, and still is, essential for subsistence communities to maintain their food and economic security. In the Shantung Province in China, cotton is broadcast into nearly-mature stands of wheat, adding almost a month to the cotton growing season. Maize and pigeon pea intercropping is common in East Africa, a practice that fixes nitrogen while providing farmers with both food and fiber crops necessary for subsistence.

These are just a few examples of the locally-adapted, sustainable techniques based on the same philosophies that influenced the French-intensive method. In developing countries, especially, global development threatens the survival of this land-based knowledge as industrial agriculture encroaches on smallholder farms. Our responsibility, then, is to protect and preserve this knowledge for future generations. As Liberty Hyde Bailey, one of America’s foremost horticulturists, said, speaking of indigenous practices in East Asia, “We may never adopt particular methods, but we can profit vastly by their experience.”

-
- 2 King, F. H. 2004. Chapter IX. Utilization of Waste in *Farmers of Forty Centuries: Organic Farming in China, Korea and Japan*. Mineola, New York: Dover Publications, Inc. (Note: originally published in 1911 as *Farmers of Forty Centuries, Or Permanent Agriculture in China, Korea, and Japan*, reprinted by Rodale Press in 1973.)
 - 3 Martin, O. 2007. *French-Intensive Gardening: A Retrospective*. For the Gardner series. Center for Agroecology & Sustainable Food Systems. Available online at: casfs.ucsc.edu/about/publications/for_the_gardener.html

SUPPLEMENT 3

Tillage & Bed Formation Sequences for the Small Farm

Understanding tillage sequences is critical for good soil and bed preparation prior to spring planting. Ill-timed or poorly executed tillage will lead to frustration and soil cloddiness. This is especially true for more challenging soils higher in clay content. The specific sequences you use will depend entirely on soil type and implement selection.

Here are two examples of common tillage and bed formation sequences (see Appendices 5 and 6 for more information on implements). One uses a mechanical spader to incorporate cover crop residue, the second an offset disc.

Spring Incorporation of Cover Crop Residue and Bed Formation

Tools: Flail mower, mechanical spader, rolling cultivator

- Flail mow cover crop at appropriate soil moisture to minimize compaction
- Immediately after flail mowing cover crop, use a spader to incorporate residue
- Immediately after spader incorporation of cover crop, form beds with rolling cultivator
- Allow adequate time for breakdown of cover crop residue. If rainfall is not adequate after bed forming then pre-irrigate to maintain enough moisture to facilitate residue breakdown.
- Shortly after weed emergence re-work the beds with rolling cultivator

Beds are now ready for shaping and planting.

Tools: Flail mower, heavy offset disc, chisel, rolling cultivator, rototiller

- Flail mow cover crop at appropriate soil moisture to minimize compaction
- Disc and cross disc cover crop until residue is adequately cut and mixed into the top 6 inches of soil (see below for details on discing patterns)
- Chisel and cross chisel to break up compaction from disc and open up ground. It may be necessary to disc again after chiseling.
- Form beds with rolling cultivator*
- Shortly after weed emergence re-work the beds with rolling cultivator

Beds are now ready for shaping and planting.

* Note: It may be necessary to rototill to break up clods prior to bed formation. Moisture from either rain or sprinkler irrigation will facilitate rototilling. Once clods are mitigated then beds can be formed with the rolling cultivator.

Bed Shaping

Once beds are raised with either listing shovels or a rolling cultivator, and assuming optimum tilth has been achieved through well-timed tillage, a “bed shaper” can be used to shape a bed suitable for precision seeding and follow-up weed management.

Bed shapers are three-point implements that run behind the tractor and flatten out the bed top, providing a smooth, uniform, and well-defined bed for planting. Vegetable seeders can be attached directly to the shaper so that beds can be shaped and planted in one pass. Markers can also be attached to the shaper to provide distinct lines for transplanting. For information on direct seeding and transplanting following bed formation, refer to Unit 1.4. Transplanting and Direct Seeding.

Discing and Discing Patterns

Vegetable growers on California’s Central Coast rely on drawbar-pulled offset wheel discs, often with a ring roller run behind, as a primary means of tillage. The disc/ring roller combination quickly and efficiently mixes crop residue with the soil and effectively knocks down and incorporates weeds that have emerged in non-cropped open fields.

One advantage of discing is the speed at which ground can be covered. For example, an 8-foot wide offset disc running at the optimum 4 miles per hour can easily cover an acre in 20 minutes.

However, for small farms, discing with a drawbar-pulled offset wheel disc can be challenging, as it is difficult to disc small plots of ground (a half

acre or less) effectively. Discs don't corner well and require significant space to turn. They move soil around in a field (especially in small plots), necessitating either the use of a land plane or wheel scraper to cut high spots and fill low spots left by the disc. Field corners are most notable for soil deposition or removal.

In small plot situations (half acre or less) where cover crop residue is not excessive, flail-mowed cover crop residue can be effectively incorporated with a three-point rototiller behind a small tractor. Multiple passes with a three point off-set or tandem disc will also work to incorporate moderate amounts of cover crop residue, but these implements tend to be light and will require more passes compared to the heavier offset wheel discs. Notched blades on a three-point disc will greatly enhance its ability to work deeper and cut through heavy residue.

One of the most important considerations when pulling a draw bar-hitched offset wheel disc is the need to disc in a "pattern" (see Appendix 7). Drawbar-pulled offset discs can only be turned to the left. Turning the disc to the right when it is soil engaged will result in serious damage to the disc frame or the discs themselves. This is very important to understand.

While running through the field the front gang of discs throws soil to the right and the second gang throws the soil back to the left (as viewed from the back of the disc forward). The back gang leaves what is referred to as a "dead furrow." The second pass of the disc will cover this dead furrow and leave a new one on the right side of the disc. Follow the last pass on the right side to minimize the number of dead furrows in the field.

As an example, when discing a one-acre plot, it is important to disc in a pattern that allows you to make left turns only and follow your last pass on the right side. If done correctly the field would have a dead furrow down the middle and along each of the two sides.

It is always advantageous to cross disc either on a diagonal or perpendicular to your last pass. It is not uncommon to disc a field multiple times to get the desired mixing and tilth.

Optimum soil moisture for discing is just moist enough that you don't raise a huge dust cloud. On soils prone to compaction, discing when soil moisture is too high can be extremely detrimental to soil tilth—the soil should never be so wet that the soil

sticks to the discs.

Note that there are many different configurations for offset discs but they all have two disc gangs that are diagonally opposed. Many of the small offset discs are set up on a three-point hitch, but their light weight limits their usefulness.

Other Tillage Operations

Deep tillage (ripping)

On most soil types, deeper tillage (i.e., ripping) is best done in the fall at the end of the cropping season when the soil is relatively dry prior to the onset of fall rains so that the compacted layers "fracture" effectively. Deep ripping is critical on some soils to improve water infiltration and break up compacted layers formed from prior shallower tillage.

Ripping is usually followed by discing to break up clods brought to the surface from the ripping. A ring roller running behind the disc should be used to break clods and push small clods into the soil so that they will more easily take in and hold moisture from irrigation or rainfall.

Ripping typically involves two passes, with the second pass done diagonally to the first pass. This second pass allows the ripper to penetrate deeper, allows for a more complete "shatter" of the sub soil, and is much easier on the tractor operator than a perpendicular pass since the tractor will rock from side to side rather than slam up and down as it goes over the soil indents left from the first pass. Ripping is a slow, energy intensive and tedious task and requires excellent traction.

SUPPLEMENT 4

Field-Scale Row Spacing

Choosing the proper bed configuration/row spacing for your farm is one of the most important decisions you will make as a beginning farmer. This decision is often dictated by the wheel spacing on your tractor, depending on the tractor or tractors you use in your operation (see Figure 1, below).

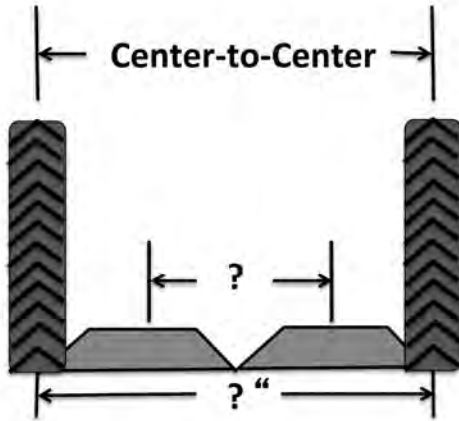

Figure 1

Row crop tractors are “adjustable” for a range of row spacings but are only designed for “in row” field operations such as planting and cultivation. The challenge many small farmers face is that they can only afford one tractor for both in row and tillage operations, and most tractors designed for pulling heavy tillage equipment (discs, chisels etc.) are not suitable for in row field operations.

As a compromise, many small farmers in California’s Central Coast region use small 4-wheel drive tractors for both tillage and in-row operations. This can work, but because the wheel spacing cannot be adjusted (or only minimally adjusted) on 4-wheel drive tractors, the distance between the tractor tires will dictate the row spacing.

The center-to-center spacing between the rear tires is the most important thing to measure since the rear tires are wider and they “lock” into the furrow. The front tires must fit within the footprint of the rear tires. Many small 25 to 35 HP tractors are set on rear wheel spacings ranging from 48 inches “on center” to 60 inches “on center.” Larger HP tractors (80 HP and up) typically used in larger scale row crop systems are almost all set at 80 inches “on center” (see Figure 2).

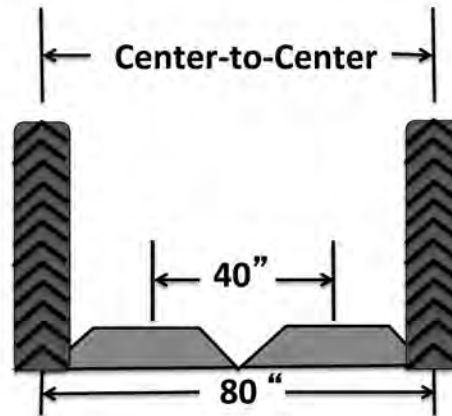

Figure 2

Once you know the center-to-center spacing of your rear tires then all bed forming implements (i.e., furrowing shovels, bed shapers) must be set to this spacing. All other “in-row” implements used following the initial bed forming must also match this spacing (i.e., planting sleds, cultivators, mowers, bed recycling discs, rototillers etc.). Most small farms are thus either on a 48” or 60” bed spacing. These spacings dictate either a single 48”- or 60”-wide bed, or two 24”- or 30”-wide beds (see figures 3 and 4).

Another critical consideration when setting up bed spacings is tire width. If possible, tires should not be any wider than 12 inches for vegetable farming if you plan on getting into the field to perform in-row operations after beds have been formed. Wider rear tires will take up critical production space.

Also note that most lower-horsepower 4-wheel drive tractors have poor clearance for “in-row” work. The basic limitation with poor clearance is that final cultivations on taller crops (e.g., sweet corn, peppers, eggplant, tomatoes) must be done much earlier, since crop height will dictate timing. This limitation could impact weed management options.

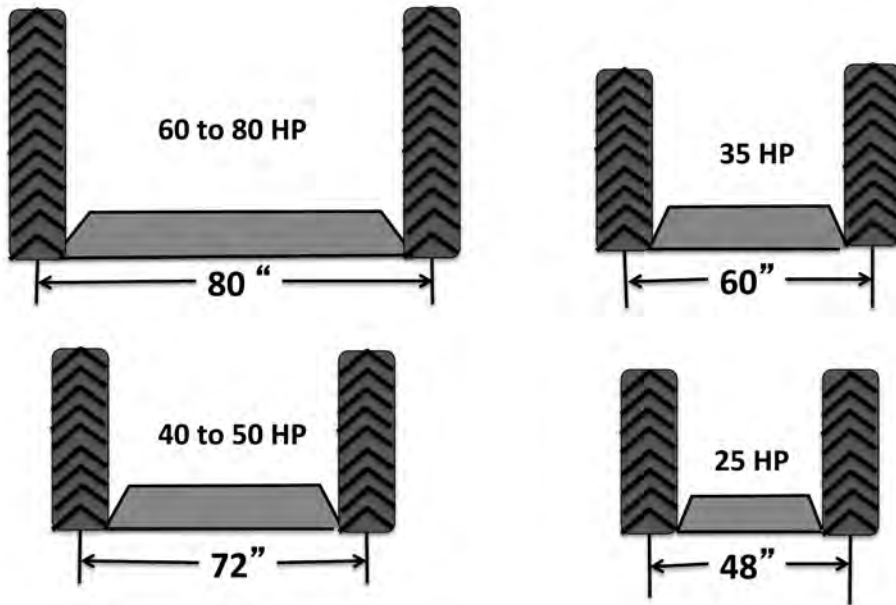

Figure 3

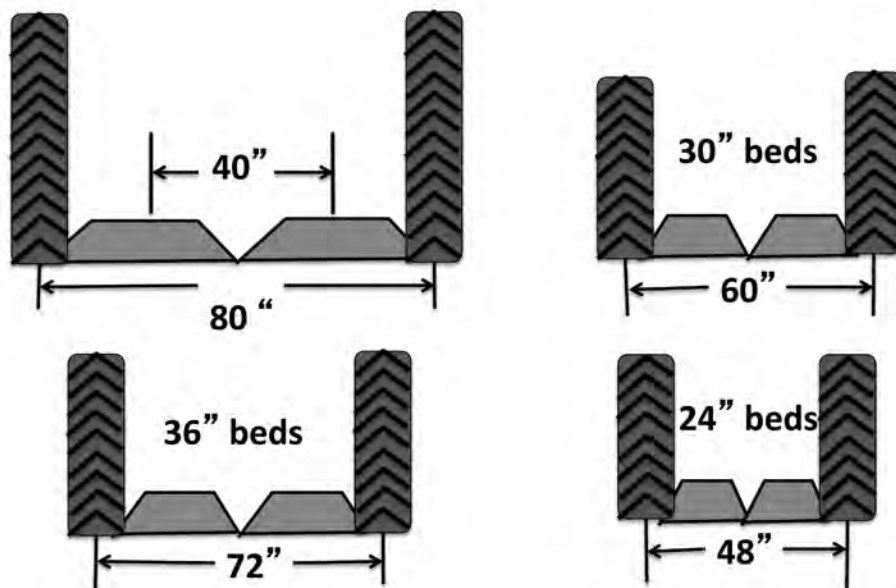

Figure 4

Basic tractor configurations:

Standard – basic 2 wheel drive (2WD) tractor in the 25 to 40 HP range

Row Crop – 2WD high clearance, adjustable tire width, upright exhaust, 12-inch rear tires, 25 to 50 HP (occasionally with belly bar cultivators)

Compact Utility – 25 to 35 HP 4WD with front loader, 16-inch rear tires, non-aggressive tire tread, often hydrostatic transmission

Mudder – 80 HP 4WD “row crop,” front and rear tires same diameter

Orchard – very wide tires, fenders, low clearance, exhaust out the back

Vineyard – very narrow

Industrial – Front loader, 2 or 4 WD, painted yellow, non-aggressive tire tread

Crawler – “caterpillar” or “track layer” tractor used for high traction applications. Good stability on steep slopes, minimal compaction, very expensive to work on.

Many small-scale row crop operations (5–10 acres) use “Standard” and “Compact Utility” configurations. Many medium-scale row crop operations (10–25 acres) use “Row Crop” configurations and most larger row crop operations (25 acres and up) utilize “Mudder” configurations.

Glossary

Aerobic

Oxygen containing

Cultivation

The total assemblage of tools and techniques used in the development and maintenance of soil fertility and crop production in garden and farm systems

Diffusion

The dispersal of gases through a medium

French intensive

A traditional method of horticulture developed in France that emphasizes intensive cultivation, high application rates of soil amendments, and high-density planting

Granular structure

A specific and desirable form of soil structure

Humus

Residual and decomposed organic matter held in the soil

Infiltration

The absorption of water into the soil

Organic matter

The material held in or on the surface of the soil that is alive or was once living tissue of plants and/or animals

Pan

A horizon or layer in soils that is strongly compacted or high in clay content

Percolation

The downward movement of water through soil horizons

Pore space

The air spaces between soil particles

Primary cultivation

Initial course cultivation used to break up soil mass into smaller particles, incorporate cover crops or soil amendments in preparation for planting seed or transplants

Secondary cultivation

Soil cultivation used to further render soil into finer particle sizes in the preparation of seed and root beds. Used subsequent to primary cultivation.

Soil horizon

An individual and distinct layer of soil (e.g., a horizon)

Soil organic matter

Organic matter held in the soil

Soil separates

Individual soil particles of sand, silt, and clay

Soil structure

The physical arrangement of individual soil particles, the way they cling or aggregate

Soil texture

The classification of a soil based on the relative percentages of sand, silt, and clay

Soil tilth

The physical condition of a soil as related to the ease of tillage, fitness as a seedbed, and impedance to seedling and root penetration

Tillage

The operation of implements through the soil to prepare seedbeds and root beds

Appendix 1: Estimating Soil Moisture by Feel

SOIL MOISTURE LEVEL (% OF FIELD CAPACITY)	COARSE (SAND)	LIGHT (LOAMY SAND, SANDY LOAM)	MEDIUM (FINE, SANDY LOAM, SILT LOAM)	HEAVY (CLAY LOAM, CLAY)
0–25% No available soil moisture. Plants wilt.	Dry, loose, single grained, flows through fingers. No stain or smear on fingers.	Dry, loose, clods easily crushed and will flow through fingers. No stain or smear on fingers.	Crumbly, dry, powdery, will barely maintain shape. Clods, breaks down easily. May leave slight smear or stain when worked with hands or fingers.	Hard, firm baked, cracked. Usually too stiff or tough to work or ribbon ¹ by squeezing between thumb or forefinger. May leave slight smear or stain.
25–50% Moisture is available, but level is low.	Appears dry; will not retain shape when squeezed in hand.	Appears dry; may tend to make a cast ² when squeezed in hand, but seldom will hold together.	May form a weak ball ² under pressure but will still be crumbly. Color is pale with no obvious moisture.	Pliable, forms a ball; will ribbon but usually breaks or is crumbly. May leave slight stain or smear.
50–75% Moisture is available. Level is moderate to high.	Color is darkened with obvious moisture. Soil may stick together in very weak cast or ball.	Color is darkened with obvious moisture. Soil forms weak ball or cast under pressure. Slight finger stain, but no ribbon when squeezed between thumb and forefinger.	Color is darkened from obvious moisture. Forms a ball. Works easily, clods are soft with mellow feel. Will stain finger and have slick feel when squeezed.	Color is darkened with obvious moisture. Forms good ball. Ribbons easily, has slick feel. Leaves stain on fingers.
75% to field capacity (100%) Soil moisture level following an irrigation.	Appears and feels moist. Color is darkened. May form weak cast or ball. Will leave wet outline or slight smear on hand.	Appears and feels moist. Color is darkened. Forms cast or ball. Will not ribbon, but will show smear or stain and leave wet outline on hand.	Appears and feels moist. Color is darkened. Has a smooth, mellow feel. Forms ball and will ribbon when squeezed. Stains and smears. Leaves wet outline on hand.	Color is darkened. Appears moist; may feel sticky. Ribbons out easily, smears and stains hand, leaves wet outline. Forms good ball.

¹ Ribbon is formed by squeezing and working soil between thumb and forefinger

² Cast or ball is formed by squeezing soil in hand

See also:

USDA, Natural Resources Conservation Service. 1998. Estimating Soil Moisture by Feel and Appearance. Program Aid Number 1619. www.nrcs.usda.gov/wps/portal/nrcs/detail/mt/newsroom/?cid=nrcs144p2_056492 and www.ext.colostate.edu/sam/moisture.pdf

Appendix 1 (cont.): Estimating Soil Moisture By Feel

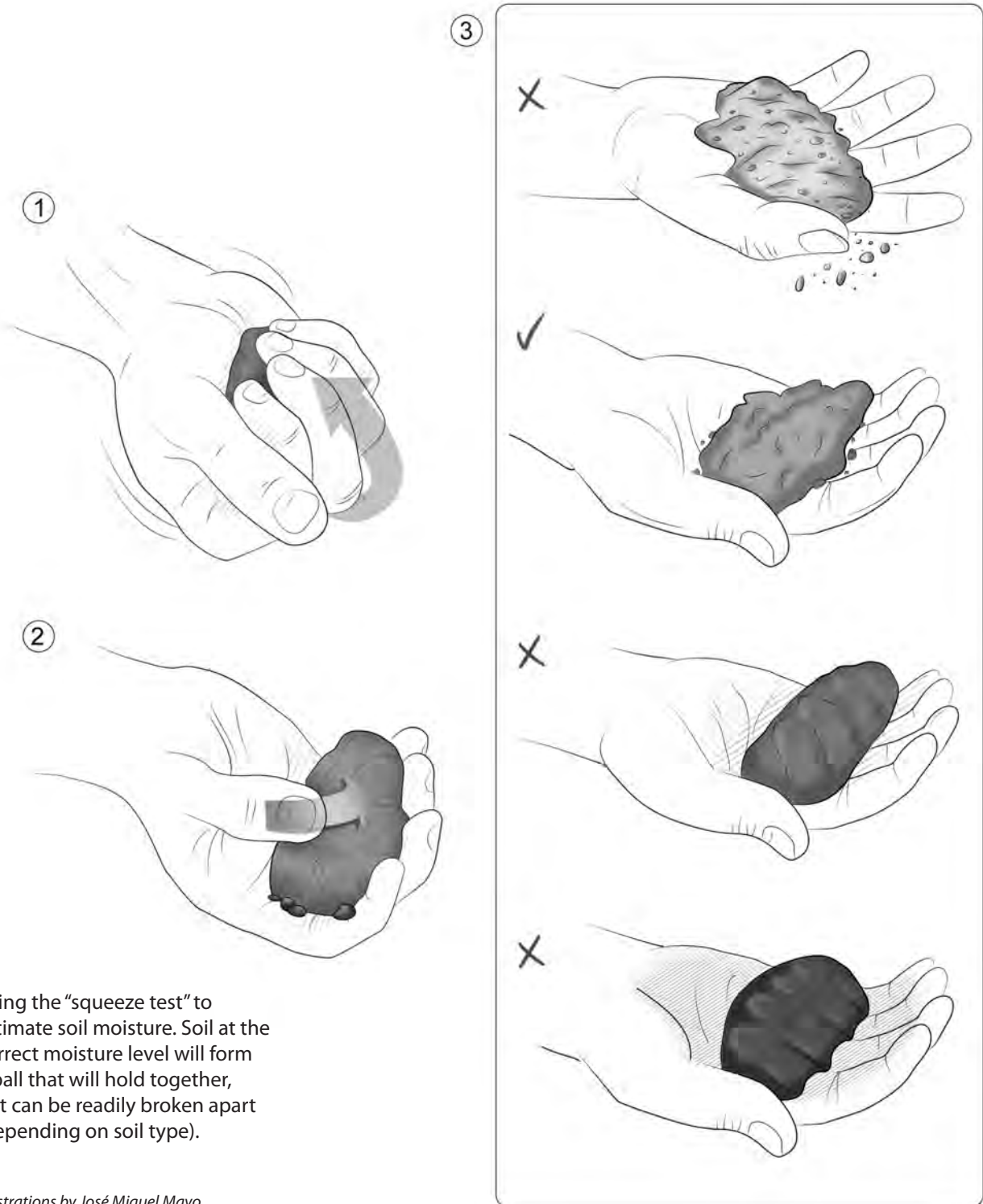

Using the “squeeze test” to estimate soil moisture. Soil at the correct moisture level will form a ball that will hold together, but can be readily broken apart (depending on soil type).

Illustrations by José Miguel Mayo

Appendix 2: Garden-Scale Tillage & Planting Implements

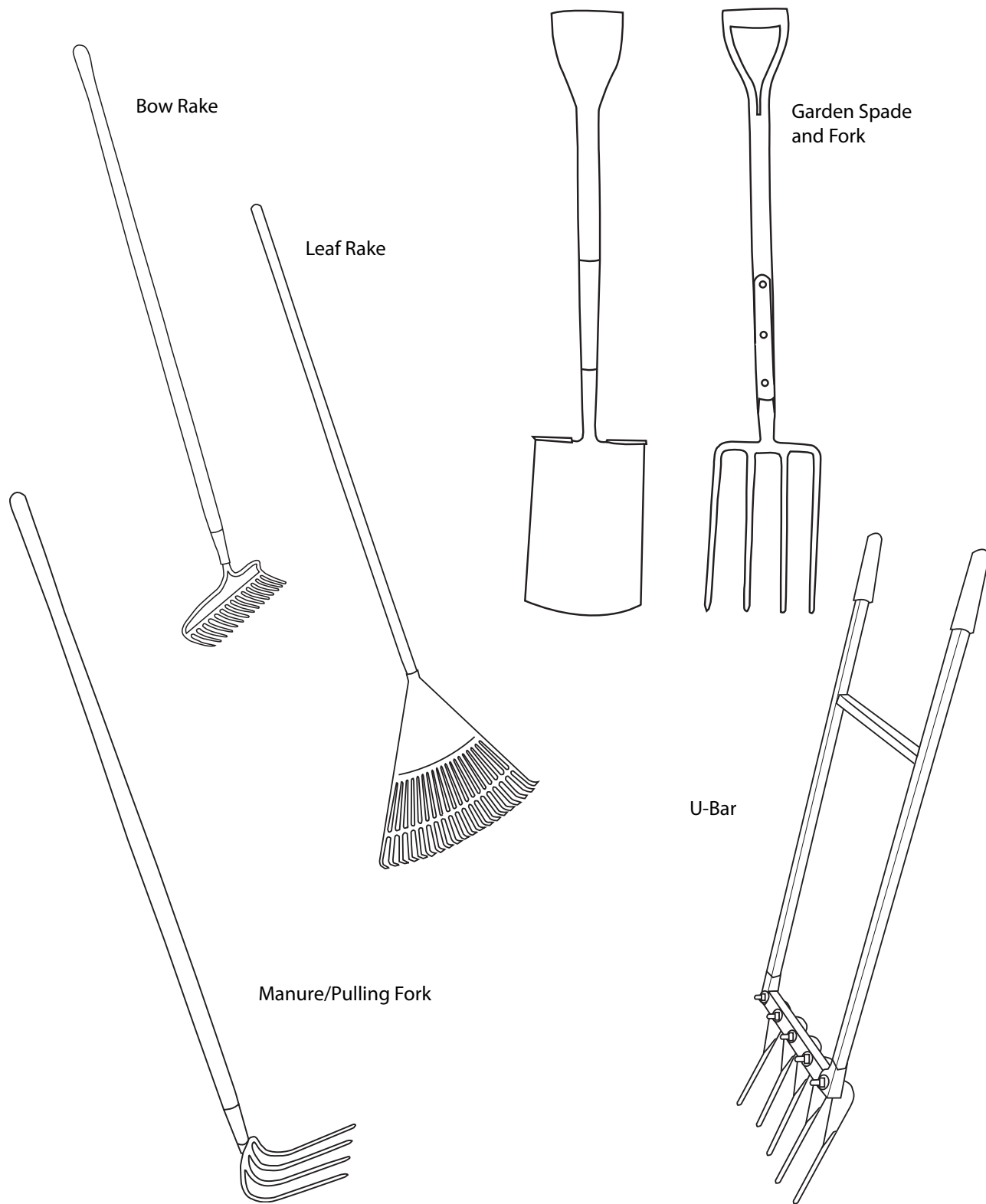

Illustrations by Cathy Genetti Reinhard

Appendix 3: French Intensive/Double-Digging Sequence

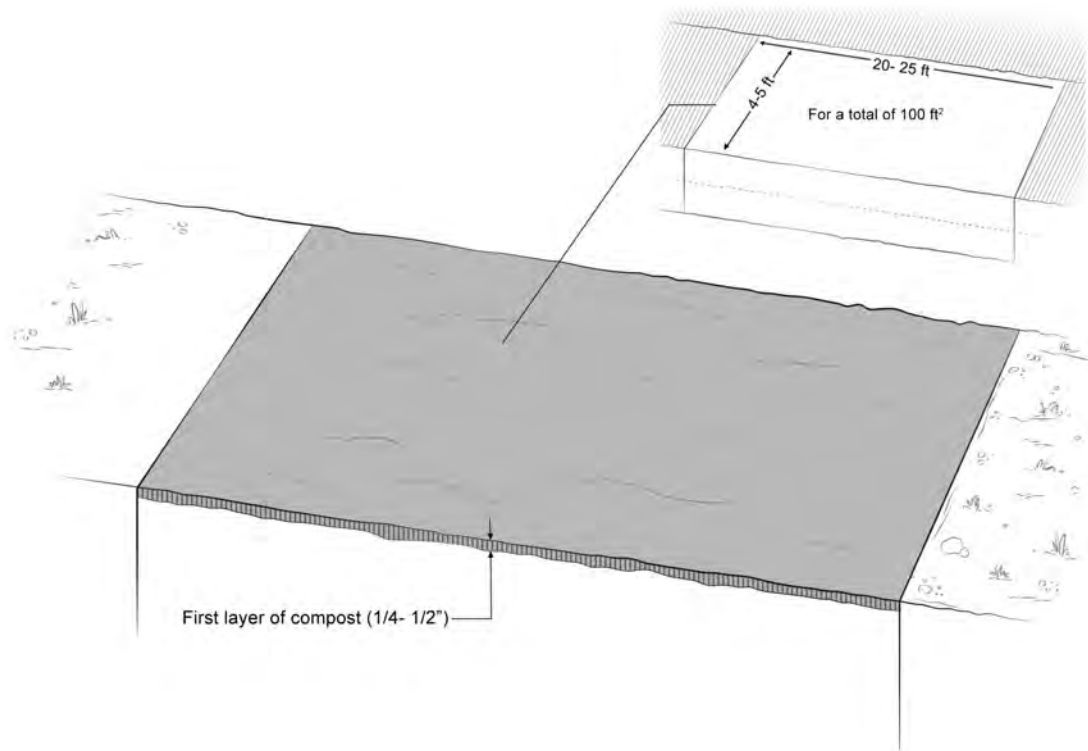

Step 1. Spread a 1/4"–1/2"-deep layer of compost on top of the bed.

Step 2. Create a trench, 12" x 12" across the width of the bed. Place soil from this trench into a wheelbarrow; it will later be used to fill the last trench in the bed.

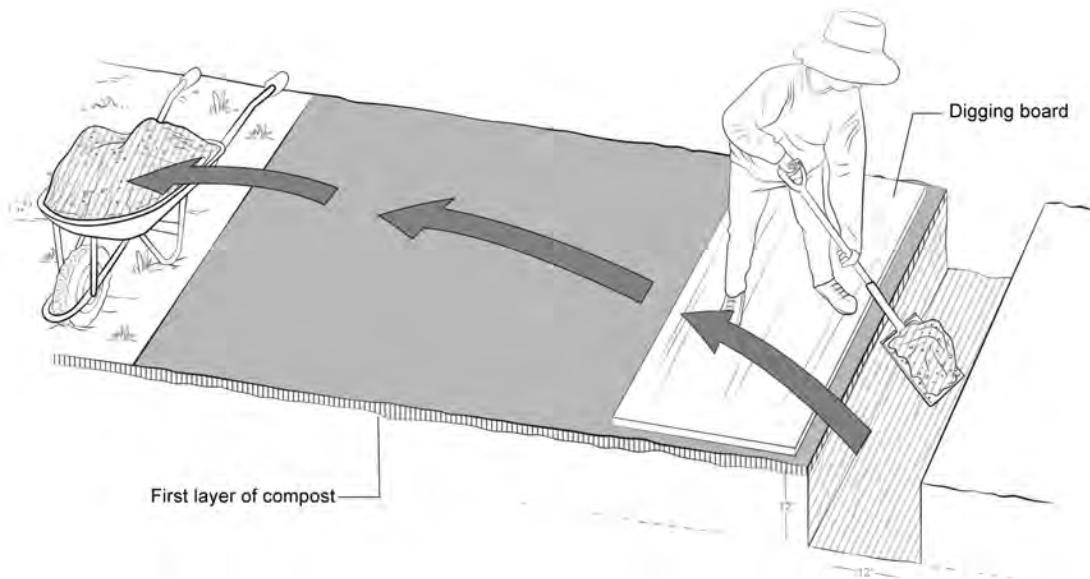

Illustrations by José Miguel Mayo

Appendix 3 (cont.): French Intensive/Double-Digging Sequence

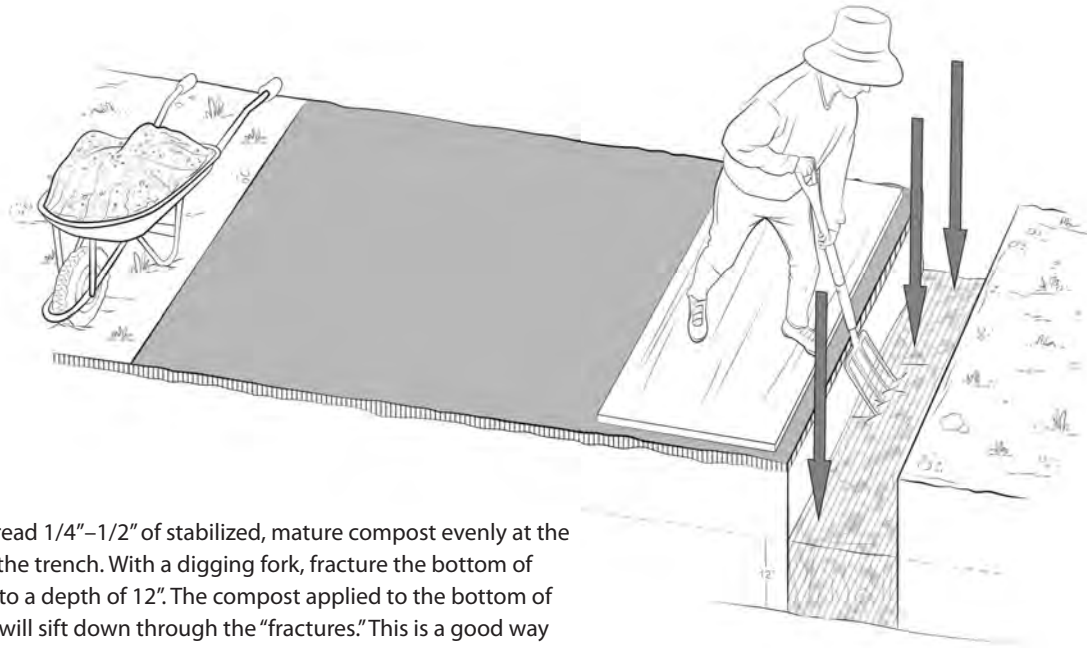

Step 3. Spread 1/4"–1/2" of stabilized, mature compost evenly at the bottom of the trench. With a digging fork, fracture the bottom of the trench to a depth of 12". The compost applied to the bottom of the trench will sift down through the "fractures." This is a good way to open up compacted subsoil with a high clay content.

Step 4. Slide the digging board to the left. Use a spade to slice off a 3" x 12" vertical slice of soil. Lever it forward using the digging board as a brace to fill the open trench. Working from one side to the other, repeat this step until you have opened a new trench, 12" wide and 12" deep.

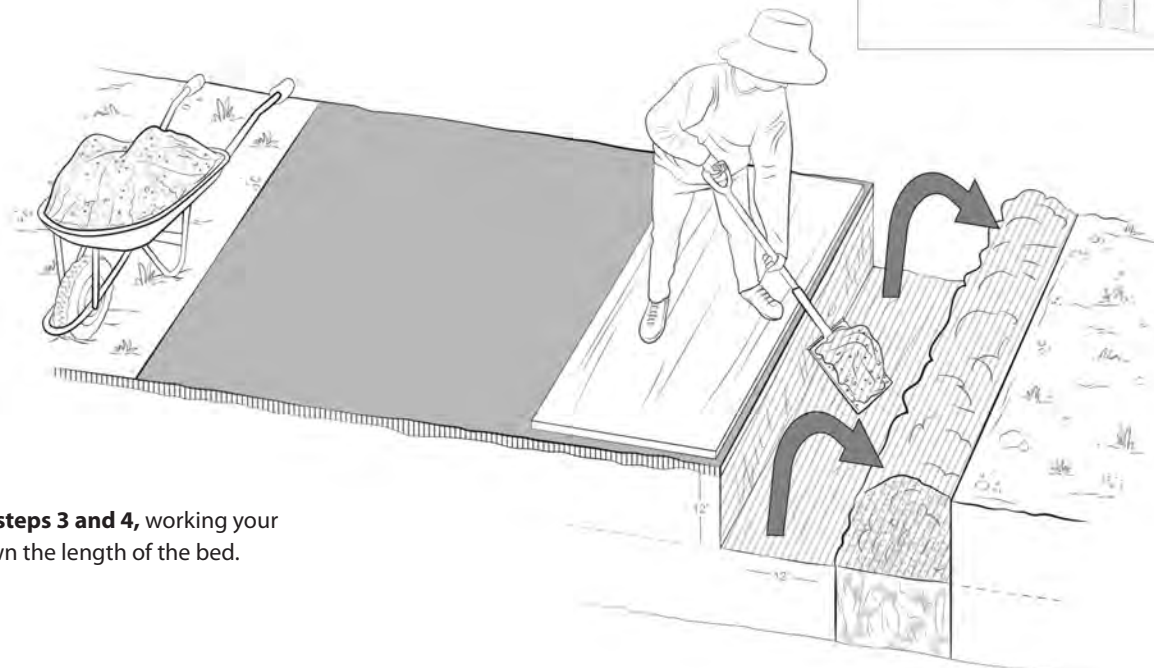
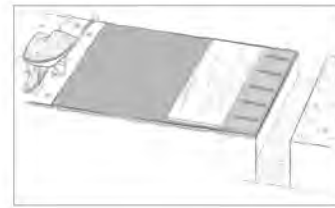

Repeat steps 3 and 4, working your way down the length of the bed.

Illustrations by José Miguel Mayo

Appendix 3 (cont.): French Intensive/Double-Digging Sequence

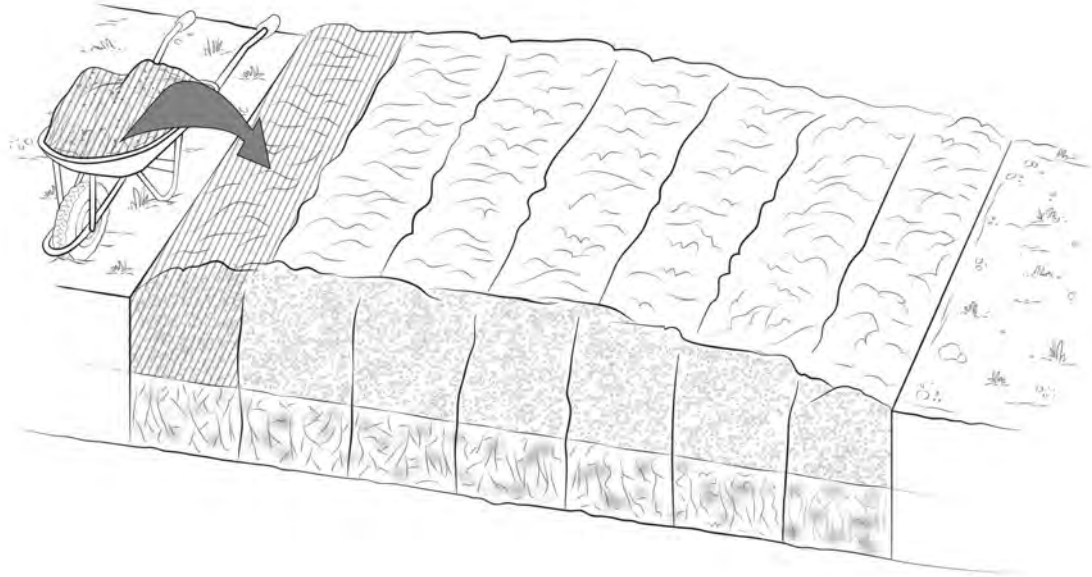

Step 5. After the final trench has been opened, compost applied, and the bottom of the trench fractured, fill the last trench with the soil from the wheelbarrow.

Illustration by José Miguel Mayo

Appendix 4: Side Forking or Deep Forking Sequence

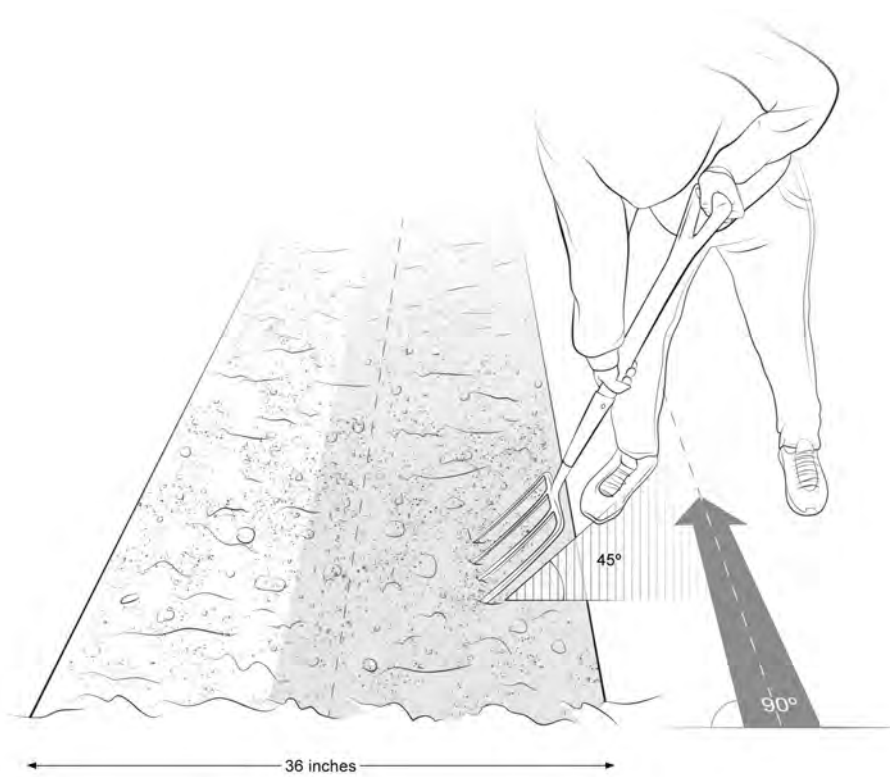

Step 1. Standing on the path perpendicular to the bed, plunge a tilting fork 6"–8" into the soil at a 45° angle. Lift and, with a shaking motion, sift the soil through the tines of the fork. The finer particle will fall through first, with the clods falling through last and remaining on the bed's surface.

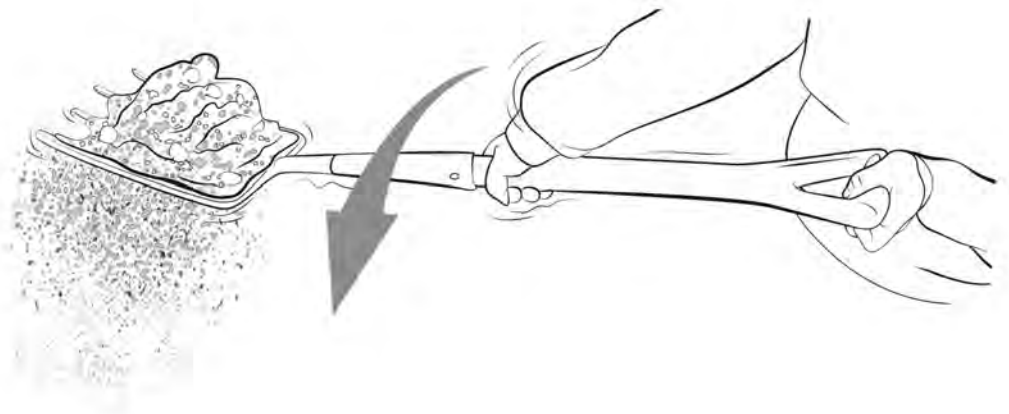

Illustrations by José Miguel Mayo

Appendix 4 (cont.): Side Forking or Deep Forking Sequence

Step 2. With a gentle, side-glancing blow, “whack” the clods until any substantial clods are broken up and eliminated. Work from the center of the bed toward the path. With each pass, center to path, slightly overlap with the previous pass.



Step 3. With a long-handled bow rake, begin to shape the bed so that it is level and straight-sided. You can draw soil from the high spots to the low spots, and vice versa. Using both sides of the rake (the tines and the flat/bow side), and using both a pushing and pulling motion will facilitate this process.

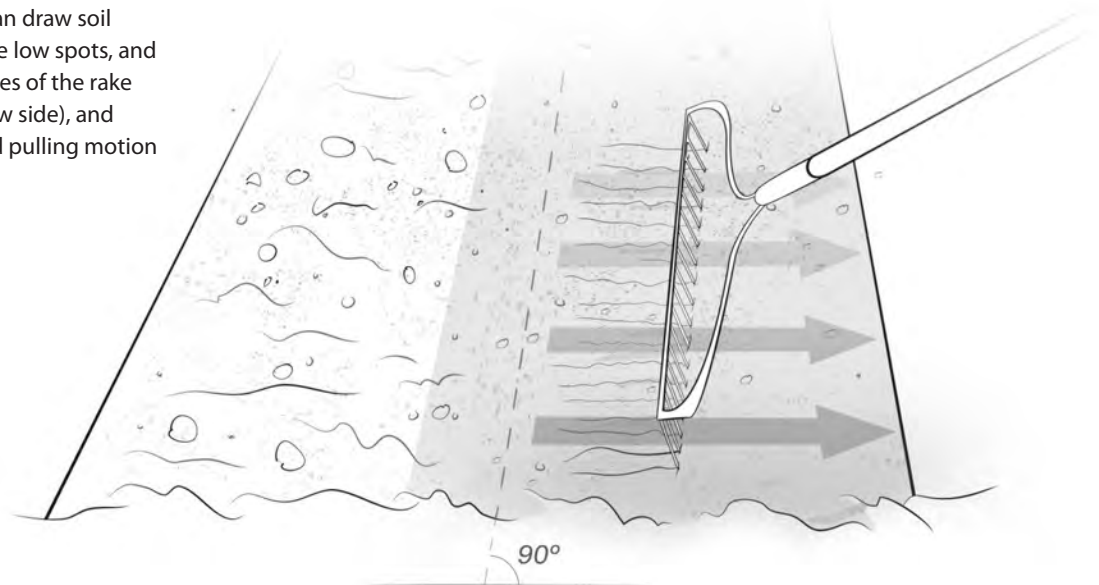

Illustrations by José Miguel Mayo

Appendix 4 (cont.): Side Forking or Deep Forking Sequence

Step 4. You can also use the rake to “berm” or gently pound the vertical side of the bed to create a firm, straight edge, perpendicular to the flat top. This helps maintain the bed’s shape.

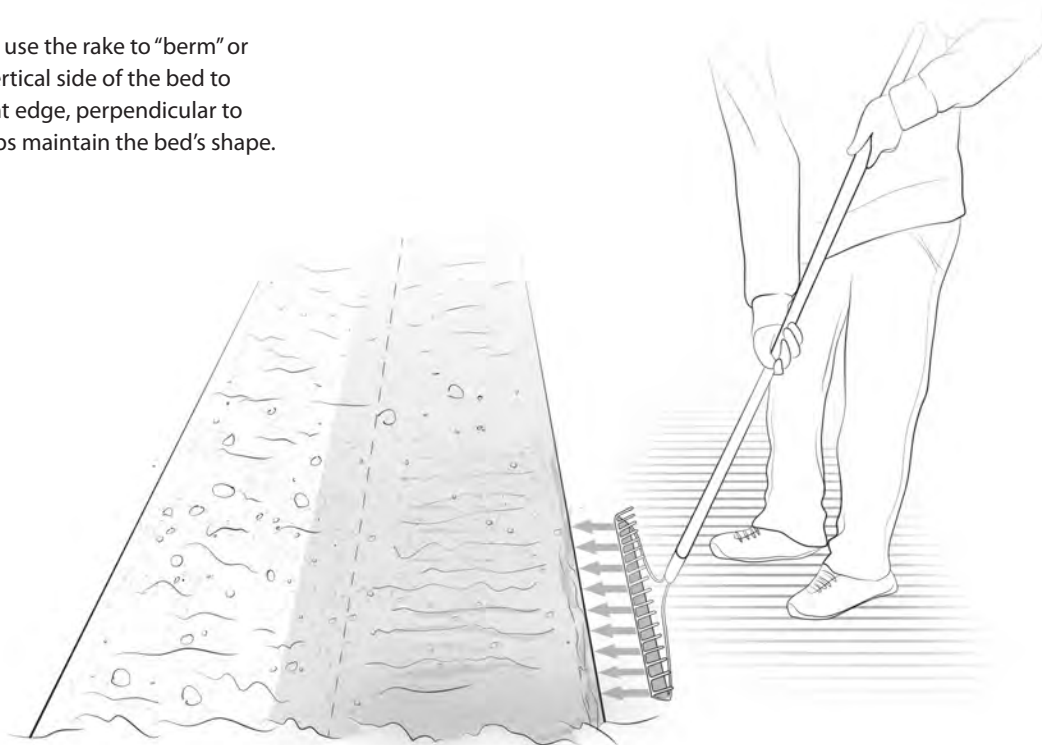
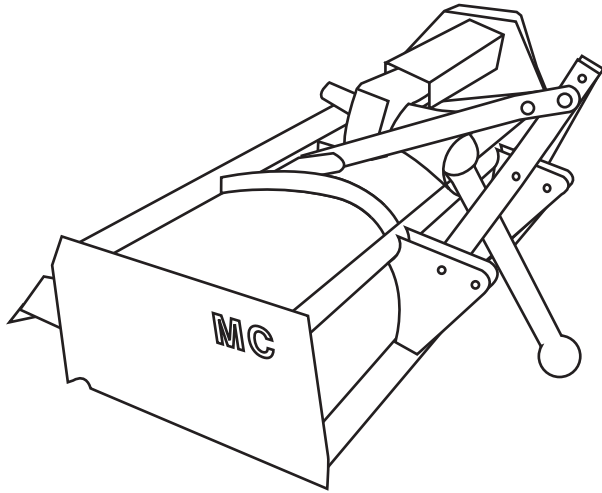
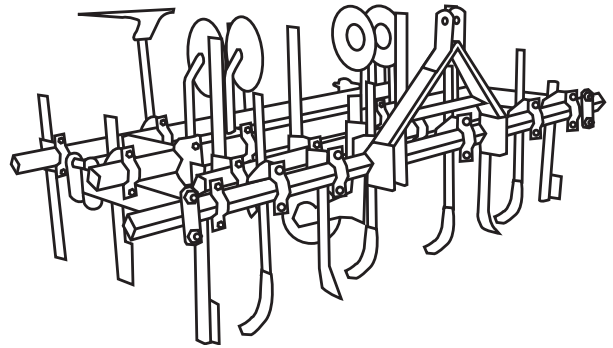

Illustration by José Miguel Mayo

Appendix 5: Field-Scale Tillage & Planting Implements



3-Point Flail Mower



3-Bar Cultivator

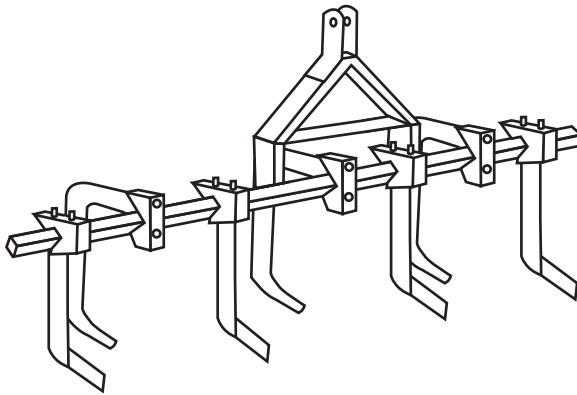

3-Point Chisel

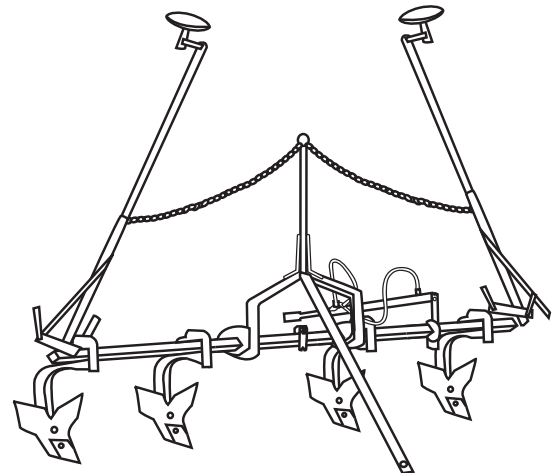

Lister Bar

Illustrations by Cathy Genetti Reinhard

Appendix 5 (cont.): Field-Scale Tillage & Planting Implements

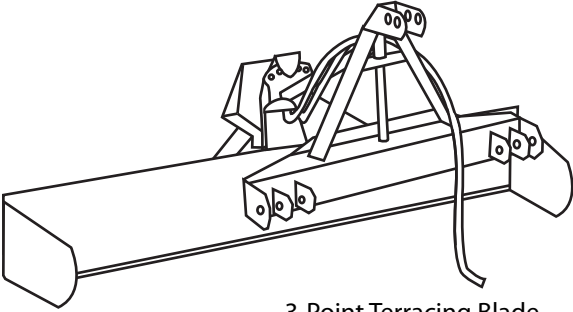

3-Point Terracing Blade

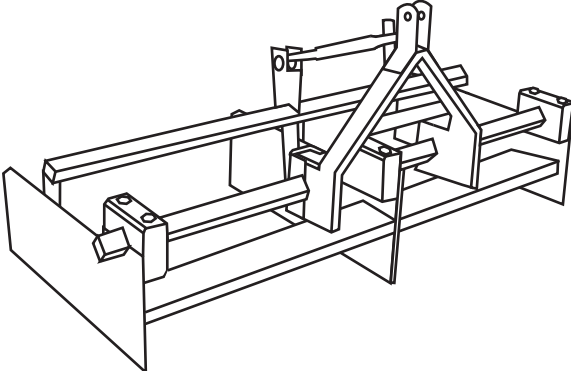

2-Row Bed Shaper

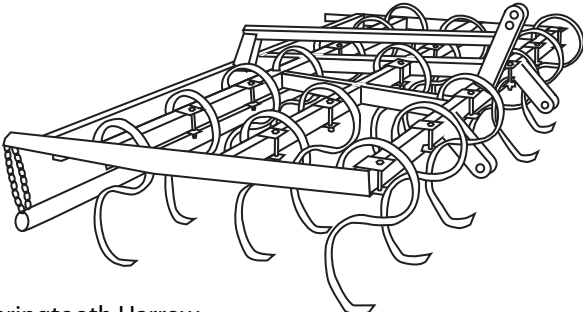

Springtooth Harrow

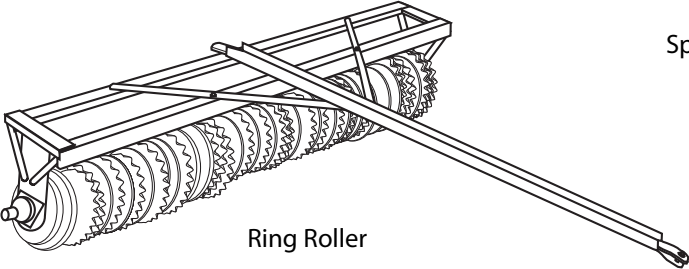

Ring Roller

Illustrations by Cathy Genetti Reinhard

Appendix 5 (cont.): Field-Scale Tillage & Planting Implements

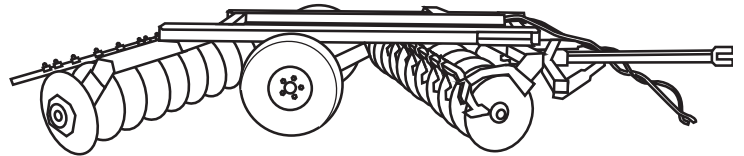

Offset Wheel Disc

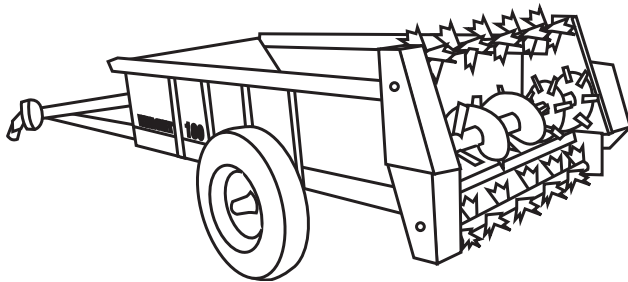

Manure Spreader

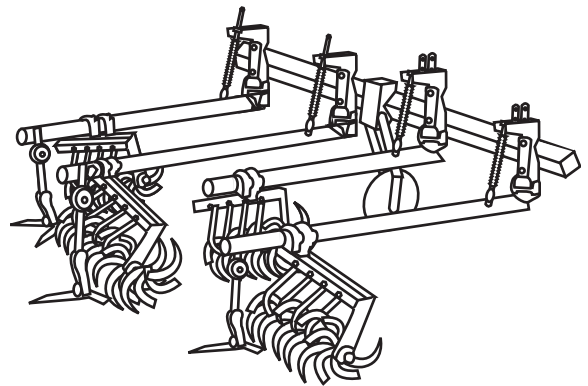

Lilliston Cultivator

Illustrations by Cathy Genetti Reinhard

Appendix 5 (cont.): Field-Scale Tillage & Planting Implements

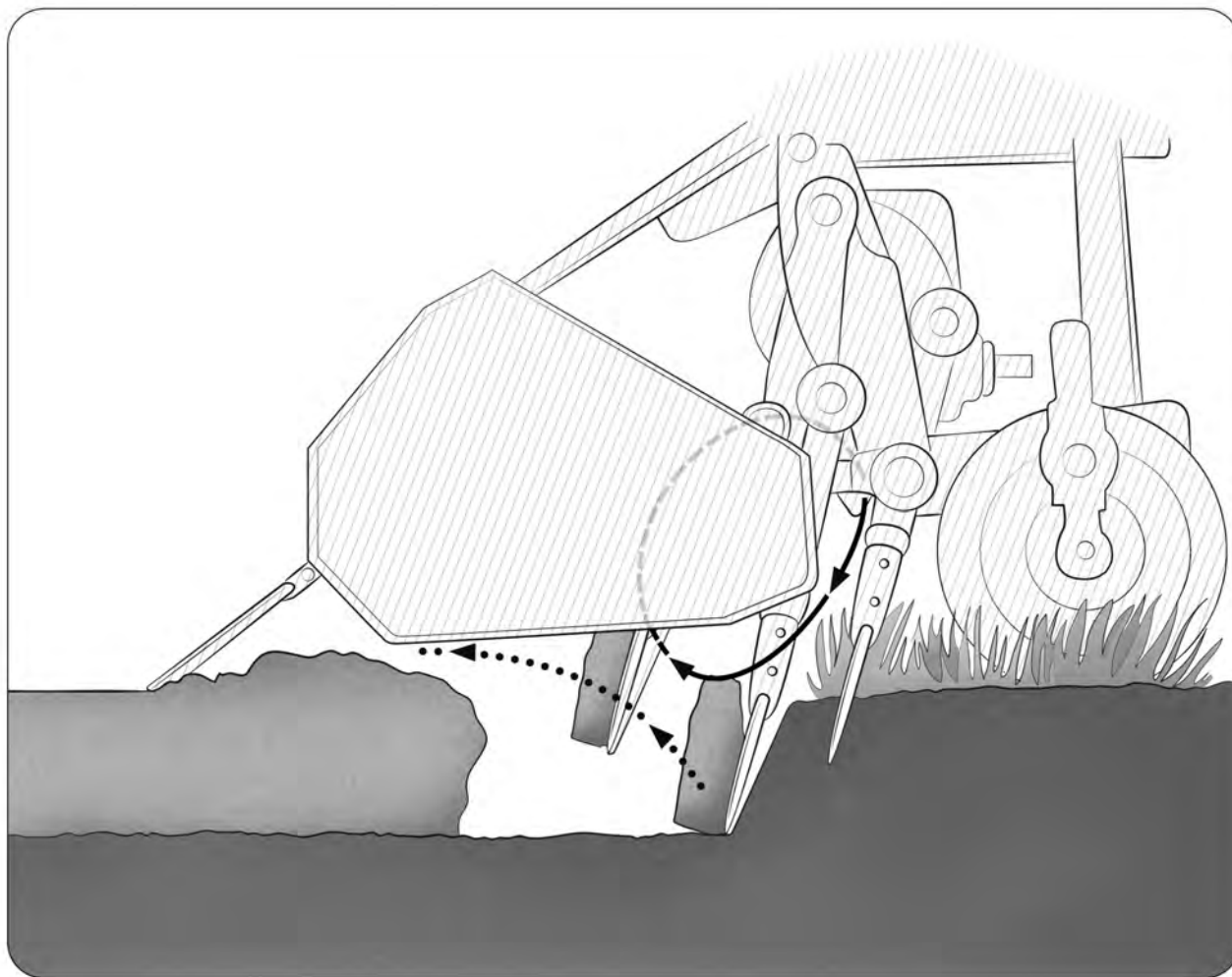

Mechanical Spader: A primary tillage implement used to incorporate cover crop and crop residue. Spaders operate at a very slow speed and perform deep tillage (14+ inches) without soil inversion to create a similar effect on soil as double digging.

Illustration by José Miguel Mayo

Appendix 6: Tractors & Implements for Mixed Vegetable Farming Operations Based on Acreage



2 to 5 acres:

- 30 HP diesel 4x4 tractor (compact utility configuration with decent clearance, "Ag" tires, three point hitch, PTO, low gearing, upright exhaust, power steering, auxiliary hydraulics etc.)
- 5 foot three point rototiller
- double tool bar and "A" frame (5.5 feet wide) with assortment of clamps, standards, shovels, sweeps, etc.
- push planter
- various hand and push cultivation tools
- single three point ripper shank capable of running 2 feet deep
- bed shaper/marker
- three point heavy tandem disc
- flail mower
- 6 foot spring-tooth cultivator
- box scraper
- under-cutter
- three point fork lift attachment for moving harvest bins etc.
- hand crank broadcaster for broadcasting cover crop seed
- backpack flamer



5 to 10 acres:

- 40 HP diesel 4x4 tractor (row crop configuration with good ground clearance, 12 inch wide tires, as well as all the amenities mentioned above)
- 6 foot three point rototiller
- double tool bar and "A" frame (6.6 feet wide) with assortment of clamps standards, shovels, sweeps
- rolling cultivator
- bed shaper with vegetable seeders
- three point ripper (two shank) capable of running 2 feet deep
- three point heavy tandem disc
- flail mower
- 6 foot spring-tooth cultivator
- box scraper
- under-cutter

- three point fork lift attachment for moving harvest bins etc.
- three point three bar cultivator with sweeps, knives, disc hillers etc. for cultivation of furrow bottoms and bed sides
- three point seed broadcaster for cover crop seeding
- backpack flamer



10 to 20 acres:

- 60 HP diesel 4x4 tractor with wide tires and weights for pulling discs, rippers etc.
- 25 to 30 HP 2 WD tractor (row crop configuration/ high clearance, three point etc.)
- 6 foot three point rototiller
- rolling cultivator
- bed shaper with vegetable seeders
- three point ripper (three shank) capable of running 2 feet deep
- off set wheel disc 7 feet wide with ring roller
- flail mower
- 8 foot spring-tooth cultivator
- hydraulic wheel scraper (6 foot)
- under-cutter
- three point fork lift attachment for moving harvest bins etc.
- three point three bar cultivator with sweeps, knives, disc hillers etc. for cultivation of furrow bottoms and bed sides
- grain drill for cover crop seeding
- mechanical spading machine (6 feet wide)
- three point heavy tandem disc with tool bar and shovels for recycling beds
- terracing blade for making drain ditches, etc.

Appendix 7: Tillage Pattern for Offset Wheel Disc

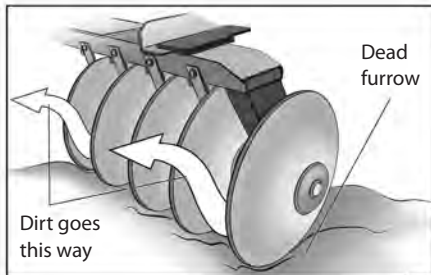

On your tight turns you can leave the disc lowered. On the broader turns you can lift the disc on the avenue so that you can avoid making a mess of the avenue. The disc will actually lift out of the ground when turning. Discs were designed to be used behind draft animals. (The pattern is exaggerated on paper).

When you are discing, all of your entry points will be in line with the field edge and your travel on the ends will be in the avenues. It is a good idea to spade the ends since the disc is not effectively cutting and mixing close to the field edge.

With an "off-set" disc you only ever turn to the left when in the field.

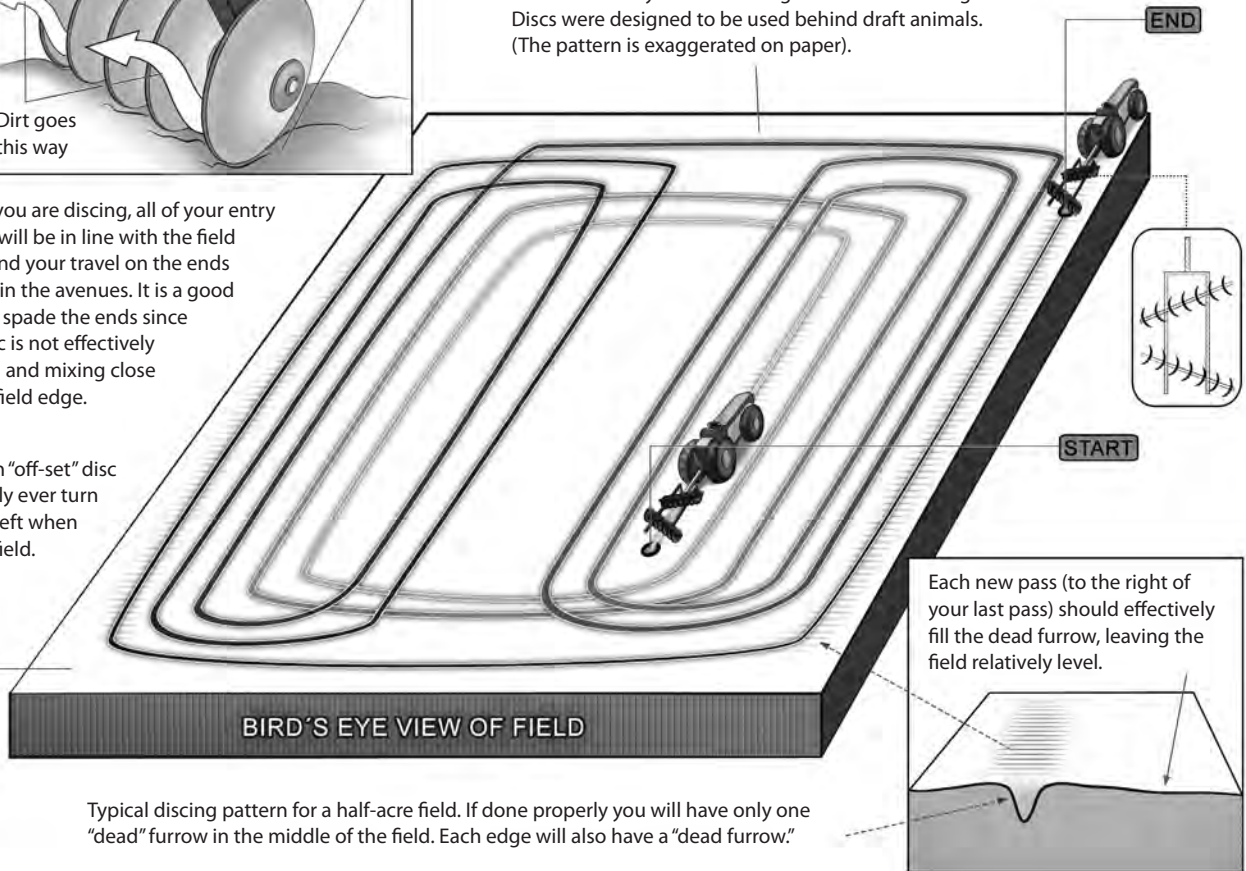

Typical discing pattern for a half-acre field. If done properly you will have only one "dead" furrow in the middle of the field. Each edge will also have a "dead furrow."

Illustrations by José Miguel Mayo

Propagating Crops from Seed, and Greenhouse Management

Introduction	97
Lecture 1: Seed Biology, Germination, and Development: Environmental Conditions and Cultural Requirements	99
Lecture 2: Managing Environmental Conditions— Using Greenhouses to Optimize Seedling Production	105
Lecture 3: Heating, Cooling, Lighting, Irrigation, and Climate Control Systems	113
Lecture 4: Soil Media, Fertility, and Container Formats	119
Demonstration 1: Greenhouse Management	
Instructor’s Demonstration Outline	127
Demonstration 2: Propagation Media	
Instructor’s Demonstration Outline	128
Demonstration 3: Sowing Seed	
Instructor’s Demonstration Outline	129
Demonstration 4: Transplanting or “Pricking Out”	
Instructor’s Demonstration Outline	130
Demonstration 5: Greenhouse Irrigation	
Instructor’s Demonstration Outline	132
Demonstration 6: Seedling Development and the “Hardening Off” Process	
Instructor’s Demonstration Outline	133

Assessment Questions and Key	135
Resources	139
Supplements:	
1. Examples of Daily Warm- and Cool-Season Greenhouse Management in a Passive Solar Greenhouse	145
2. Conserving Water and Protecting Water Quality	148
3. Low-Cost and Sustainable Alternatives to Traditional Greenhouse Propagation	149
Glossary	151
Appendices	
1. Characteristics of Open-Pollinated (OP) and Hybrid Seed	153
2. Seed Viability Chart	154
3. Soil Temperature Conditions for Vegetable Seed Germination	155
4. Days Required for Seedling Emergence at Various Soil Temperatures from Seed Planted 1/2-inch Deep	156
5. Approximate Monthly Temperatures for Best Growth and Quality of Vegetable Crops	157
6. Examples of Propagation Containers	158
7. Propagation Media—Ingredients and Properties Imparted	159
8. Sample Soil Mix Recipes	160
9. “Pricking Out” Technique, Depth of Planting	161
10. Flat-Grown and Cell-Grown Seedlings	162
11. Propagation and Crop Performance Records Sheet	163
12. Greenhouse Records Sheet	164

Introduction: Propagation/Greenhouse Management

UNIT OVERVIEW

Getting plants off to a healthy start is critical to successful crop production. This unit introduces students to the basic skills, concepts, and equipment associated with the sexual propagation of crop plants, and the use of greenhouses to promote healthy seedling production. Lectures, exercises, and supporting material emphasize the roles of temperature, moisture, air circulation, and fertility in germination, seedling development, and pest and disease control.

Four lectures examine cultural requirements of seeds and seedlings, as well as the technology, costs, advantages, and disadvantages of various greenhouse structures, and options for propagation media and container formats. A series of demonstrations then introduces the skills involved in sowing seeds and the cultural practices used to manage passive solar greenhouses to promote successful development of organically grown seedlings. Supplements address examples of daily greenhouse practices, along with ways to conserve water, protect water quality, and lower expenses associated with greenhouse propagation.

MODES OF INSTRUCTION

- > LECTURES (4 LECTURES, 1.5 HOURS EACH)
 - Lecture 1 covers seed biology, and the cultural requirements for germination and healthy seedling development.
 - Lecture 2 examines the rationale and associated costs and benefits of solar and conventional greenhouse structures, and the prevention/management of common greenhouse pest and pathogens.
 - Lecture 3 takes a closer look at greenhouse technology: heating, cooling, lighting, and irrigation systems.
 - Lecture 4 addresses desirable characteristics of propagation media, common container formats, and supplemental fertility.
- > DEMONSTRATION 1: GREENHOUSE MANAGEMENT (1–1.5 HOURS)
 - The greenhouse demonstration illustrates the way that air temperature, soil moisture, and air circulation are managed to create optimal environmental conditions for seed germination and seedling growth. Students will also be introduced to the steps used to prepare seedlings for field transplanting.
- > DEMONSTRATIONS 2–6: PROPAGATION MEDIA, SEED SOWING, TRANSPLANTING, IRRIGATION, AND SEEDLING DEVELOPMENT (1–1.5 HOURS EACH)
 - The propagation demonstrations illustrate the techniques used to produce propagation media, sow seeds, transplant seedlings, and manage irrigation and seedling development.
- > ASSESSMENT QUESTIONS (0.5–1 HOUR)
 - Assessment questions reinforce key unit concepts and skills.
- > POWERPOINT, VIDEOS
 - See casfs.ucsc.edu/about/publications, and click on Teaching Organic Farming & Gardening.

LEARNING OBJECTIVES

CONCEPTS

- Definition of sexual propagation
- Propagation media: Components, properties and ratios of materials used
- Containers: Advantages and disadvantages of commonly used formats
- Accurate documentation of propagation for trouble shooting
- Germination requirements of various crops: Seed physiology, seed treatments, temperature ranges, light, air circulation, and moisture conditions
- Physiological process of seed germination and seedling development, and its relationship to environmental conditions
- Optimal conditions for early stages of plant growth up to transplanting stage, including the hardening off process and movement of plants through facilities
- The role, timing, and tools used in supplemental fertilization
- Preventive and active pest and pathogen management

SKILLS

- How to create propagation media
- How to sow seeds into flats and cell trays
- How to manage a greenhouse/cold frame: Maintaining optimal environmental conditions for germination and early stages of seedling growth
- How to transplant/“prick out” seedlings
- How to manage seedlings in preparation for field transplanting
- How to identify appropriate life stage for transplanting to field/garden
- When and how to deliver supplemental fertilization
- How to manage pests and pathogens: Monitoring, identification resources, and active management

Lecture 1: Seed Biology, Germination, & Development—Environmental Conditions & Cultural Requirements

Pre-Assessment Questions

1. What are the advantages of propagating annual vegetables in a greenhouse or similar climate control structure compared to direct seeding crops?
2. What conditions must be met for a seed to successfully germinate and grow into a viable seedling?
3. What are the key environmental conditions that facilitate germination and influence seedling development of annual vegetables?
4. What are the characteristics of seedlings when ready for transplanting to the field or garden? What actions may growers take to prepare seedlings for transplanting into the garden or field?
5. What is the most effective way to manage/prevent the development of pest and diseases in a propagation facility? Where would you seek information to identify pests or pathogens and to find Organic Materials Review Institute- (OMRI-)/National Organic Program-certified active control options if pest and or diseases should affect your seedlings?

A. Sexual Propagation

1. Definition: The intentional reproduction of a new generation of plants by the germination and growth of seeds that were created in the previous generation through the fertilization of a plant ovary via the union of male and female sex cells. Results in a genetically unique plant generation.

For comparison, asexual propagation is the reproduction of plants by means of division, cuttings, tissue culture, etc. This process occurs in nature, but is a primary method for reproducing many ornamental cultivars and the vast majority of fruits, berries, and nuts. Clonal or asexual propagation results in a new generation of plants genetically identical to the parent or source plant, thus carrying forward all desirable/known characteristics in a predictable manner.

2. Types of plants grown from seed
 - a) Annuals: Plants that germinate, grow vegetatively, flower, and produce seeds, thus completing their entire life cycle within a single year. Sexual propagation (propagation using seeds) is the only practical means of propagation for annuals.
 - b) Biennials: Plants that complete their entire life cycle within two years. Growth is primarily vegetative in year one. In year two, growth is directed primarily toward reproduction in response to vernalization: The process wherein plants are exposed to decreasing day length and temperature followed by increasing day length and temperature. This process occurs in temperate climates when plants go from one growing season, through Winter and into the following Spring. Sexual propagation is the only practical means of reproducing biennial crops.

- c) Perennials: Plants that live more than two years. Once beyond their juvenile life phase, perennials grow vegetatively, flower, and produce seeds every year. The life span of perennials depends on the genetics of the species and the environmental conditions in which the plants are growing. By definition, perennials can live three to thousands of years, but lifespan within a particular species tends to vary. Perennials can be grown from seed, although many are reproduced asexually/vegetatively to hasten maturity, maintain genetic uniformity, and therefore retain desired morphological characteristics.
3. Open pollinated (OP) and hybrid seed (see also Appendix 1, Characteristics of Open-Pollinated (OP) and Hybrid Seed)
- a) Open-pollinated seed: Produced when a parent plant is fertilized by another member of the same genetically stable population. Offspring bear traits or qualities that closely resemble the parent population. These seeds may come from:
 - b) F1 Hybrid seeds: The product of cross pollination of two different, but homogeneous inbred, stable lines, each of which contribute desirable characteristics to the subsequent generation. Seeds saved from this next generation typically possess a highly heterogeneous nature and will produce offspring unlike the hybrid parent population.

B. Seed Germination and Early Seedling Development

1. Necessary pre-conditions for seed germination
 - a) Viability: Seeds must contain living, healthy embryonic tissue capable of germination.
 - i. Viability depends upon the full development of the embryo and endosperm (nutrient storage tissue) during the development of the seed
 - ii. Viability is also contingent upon maintaining the health of the embryo and endosperm from seed maturation through seed sowing. Moisture within the seed, nutrient reserves, and an embryo's potential to germinate are finite, as determined by the genetics of the species and by the environmental conditions during seed storage. See Appendix 2, Seed Viability Chart, for typical lifespan of common vegetable seeds.
 - b) Many species also exhibit dormancy factors that inhibit or delay seed germination. Dormant seed cannot germinate under what would otherwise be conditions favorable for germination until dormancy factors have been overcome. Physical and chemical dormancy are more common in native species and plants from more extreme environments than in commonly grown vegetable and flower crops.
 - i. Physical dormancy (e.g., hard, thick seed coats): Can be broken by soaking, scarifying, exposure to soil microorganisms. Methods are species specific. (See Resources section for guides to propagation techniques.)
 - ii. Chemical dormancy: Growers replicate natural processes and environmental conditions to break internal chemical/metabolic conditions preventing seed germination (e.g., leaching, cold/moist stratification, fire scarification, etc.)
2. Environmental factors involved in germination are typically both atmospheric and edaphic (soil related). Biotic factors, such as pests, pathogens, weeds, and microbes can also be involved.
 - a) Temperature: For ungerminated seed, temperature is normally discussed in reference to soil temperature. All seeds have minimum, maximum, and optimal soil temperature ranges within which germination is possible (see Appendix 3, Soil Temperature Conditions for Vegetable Seed Germination).
 - i. Minimum: Lowest temperature at which seeds can effectively germinate. As compared to temperatures in the optimal range for a given species, days to emergence will be long, percent germination will be low and rate of subsequent growth will be slow when temperatures approach the minimum threshold for a given species.

- ii. Maximum: Each species has an uppermost temperature at which germination can occur. Above this threshold, injury or dormancy are often induced. Nearing this threshold, percent of germination often declines and days to emergence may increase.
 - iii. Optimal: Every species has an optimal temperature and corollary temperature range in which the percent germination is highest and days to emergence is the lowest. This is the target range to strive for when managing greenhouse facilities or sowing seeds outdoors.
 - iv. In addition to optimal temperatures, some species either require or benefit from day-night temperature fluctuation. Many small-seeded species, which best germinate near the soil surface, benefit from the temperature fluctuation that normally occurs at the soil surface. Germination may be inhibited in species requiring temperature fluctuation if seeds are buried too deeply, as temperatures typically remain more constant at depth.
- b) Moisture: All seeds require moisture to initiate metabolic processes and support germination. Seeds imbibe water from the soil pores in direct contact with the seed; as this soil dries, moisture is replaced by capillary action from nearby soil pores, helping facilitate germination. For most seeds, field soil or propagation media should be maintained at or above 50%–75% of field capacity during the germination phase, and have a firm, fine texture to provide good seed-to-soil contact.
- c) Aeration: Soil/media must allow for gas exchange to and from the germinating embryo
- i. Oxygen (O_2) dissolved into the soil media is required to facilitate embryonic respiration
 - ii. Carbon dioxide (CO_2), a byproduct of respiration, must be able to dissipate and move away from the seed
- Note that good soil structure enhances gas exchange, whereby gases can move into and out of the soil via the pore spaces between soil particles. Avoiding overwatering and allowing for adequate infiltration of water and subsequent dry down between irrigations also promote gas exchange. Excessive irrigation and/or poorly drained soils can limit germination and development when oxygen is crowded out of the pore spaces by persistent moisture.
- d) Light can either induce or release dormancy, depending on the species. The effect of light on sensitive species results either from light quality (wavelength) or photoperiod (the duration of exposure.) Most cultivated crops express minimal or no sensitivity to light during germination, in large part due to millennia of grower and breeder selection for consistency and reliability of germination.
- i. Most species germinate best under dark conditions by being slightly buried in the soil medium, and in some cases (e.g., Phacelia, Allium, Phlox) germination may be inhibited by light. Light inhibition is particularly common in desert species, where germination in the presence of light would likely lead to desiccation and death due to the normally dry conditions of the soil surface.
 - ii. Seeds of certain species (e.g., Lactuca, Begonia, Primula, Coleus) require exposure, however brief, to light to induce germination. This is particularly common amongst small-seeded species and is thought to be an evolutionary mechanism to prevent germination when seed is buried deeply in the soil, where a germinating seed may exhaust its resources before emerging above ground to begin photosynthesizing.
 - iii. The effect of light on germination should not be confused with necessity of light for seedling development. All seedlings require sunlight for photosynthesis and continued development.
3. Physiological steps in germination: A three-phase process leading to the emergence of roots and above-ground growth

- a) **Phase 1: Imbibition.** Rapid initial uptake of water by the dry seed, followed by a brief but gradual continuation of water uptake. This softens and swells the seed coat and occurs even in seeds that are no longer viable.
 - b) **Phase 2: Interim or lag phase.** Water uptake greatly reduced; internal physiological processes begin. From the outside, little appears to be happening, but this is a very active physiological and metabolic period within the seed.
 - i. Activation of mitochondria within cells of the seed: Supporting increased cellular respiration and energy production
 - ii. Protein synthesis: Translation of stored RNA to fuel continued germination
 - iii. Metabolism and use of stored nutrient reserves to fuel development
 - iv. Enzyme production and synthesis, leading to the loosening of cell walls around the embryo and root radicle, which will ease subsequent cell enlargement, division, and elongation
 - c) **Phase 3: Root radical emergence.** Initially, root radicle emergence results from cell enlargement, but this is rapidly followed by cell division and elongation as the root radicle pushes into the surrounding soil media.
 - d) The processes internal to the seed and the below-ground emergence of the root radicle define the process of germination. However, from a grower's perspective, we typically discuss germination in relation to when the plumule or embryonic shoot emerges above the soil surface. It is at this point that we're most aware of germination and must shift our management practices, particularly to manage for relative wet to dry swings in the soil to prevent the presence damping off organisms and other pathogens (see more in Lecture 2, Managing Environmental Conditions—Using Greenhouses to Optimize Seedling Production).
4. Early seedling development: Processes and shifting needs
- a) Continued cell division-extension of root radical and root tip from base of embryo axis, into the soil medium. Initial root development is unbranched and taproot-like.
 - b) Emergence of plumule or growing point of the shoot, from upper end of the embryo axis. Initial, above-ground seedling development follows one of two patterns, either:
 - i. Epigeous germination: Ongoing elongation of the hypocotyl, raising the cotyledons above ground where they provide stored nutrient transfer and initial photosynthesis, until the emergence of the first set of true leaves. This normally occurs within 24 hours of above-ground emergence.
 - ii. Hypogeous germination: The hypocotyl does not continue to expand, and only the epicotyl emerges above ground, soon followed by true leaves. The cotyledons deliver nutrients for early development, but usually remain at or below the soil surface, and photosynthesis comes exclusively from the true leaves.
 - c) Overall weight of seedling increases throughout developmental stages, while weight of storage tissue decreases as stored nutrients are consumed by the growing seedling
 - d) Rate of respiration and volume of water uptake steadily increase with ongoing cell division concurrent with the expansion of roots and above-ground shoots
 - e) As seedlings continue to develop through cell division and elongation, depending on the root nature the species, a taproot, fibrous, or branched root system will develop, with fine root hairs developing to increase the overall surface area available for enhanced water and nutrient uptake
 - f) Development of true leaves, roughly concurrent with development of branched root system in most species, begins process of effective photosynthesis, helping to fuel continued growth

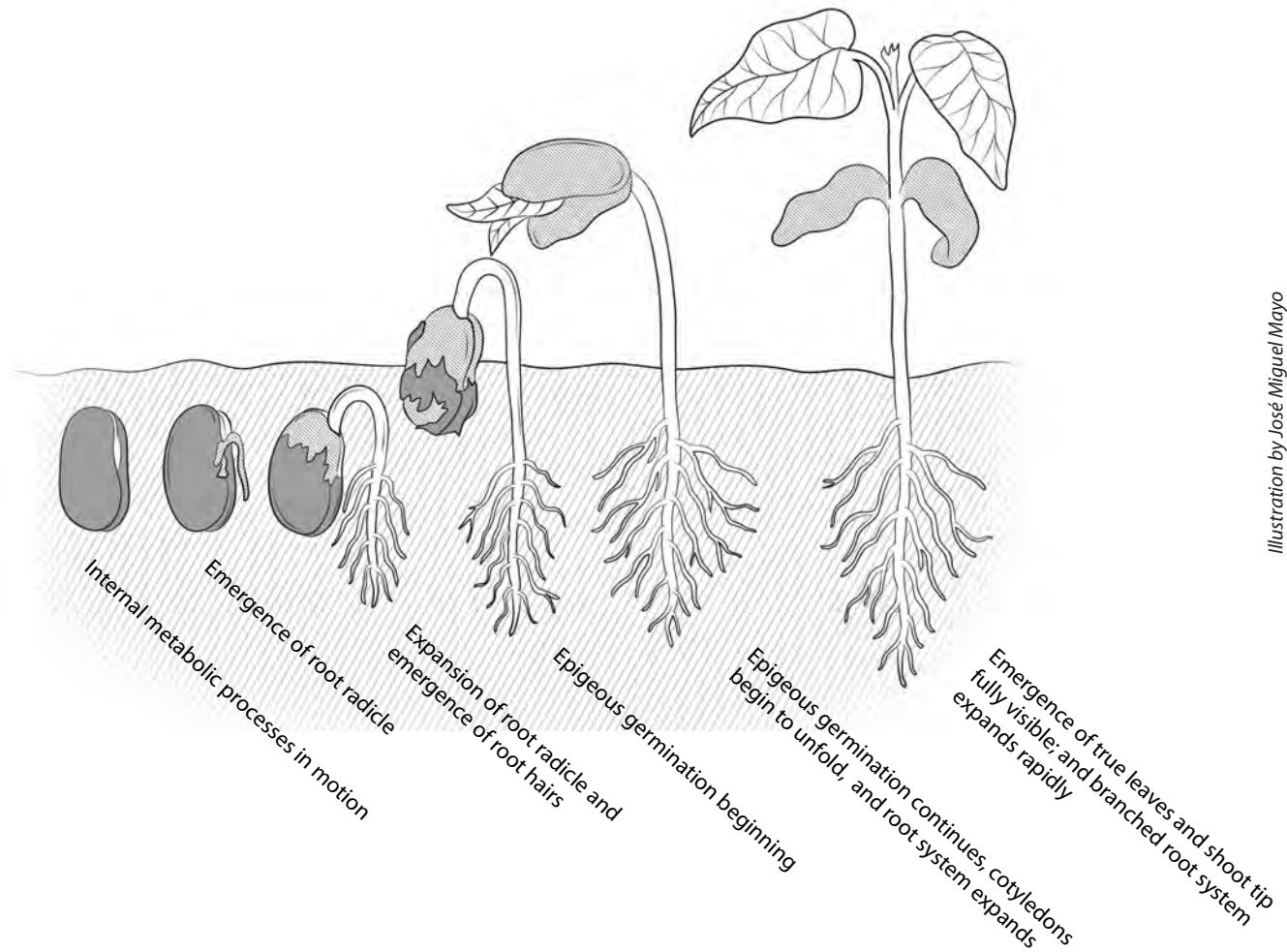

C. Typical Life Cycle of Seedlings Grown in the Greenhouse: Timeline for Days to Seedling Maturity

1. The duration of seedling life cycle and growth rate depend on a number of factors
 - a) Photoperiod and the hours of light available to support growth. For most species longer days translate into more rapid seedling growth, shorter days mean slower growth.
 - b) Temperatures within, above, or below the desirable range to stimulate or constrain growth
 - c) Sufficient, consistent moisture to fuel growth. Too much or too little can inhibit normal development.
 - d) Air circulation and gas exchange both above ground and in the root zone. Both are critical to healthy seedling development and timely development, while too little circulation or exchange invariably slows growth.
 - e) Nutrient availability, although note that excess nutrients may make for lush, weak growth, vulnerable to pest, diseases, moisture, and temperature stress. Limited nutrient supply will likely mean slow growth and poor performance. Appropriate nutrient supply will fuel steady, uninterrupted growth and reduce vulnerabilities.
 - f) Container type and cell size, with seedlings maturing as smaller transplants more rapidly in smaller cells and more slowly as larger transplants in larger cells (see more at Lecture 4, Soil Media, Fertility, and Container Formats)

2. Producing seedlings ready for transplant can take as little as two weeks for fast-growing crops such as lettuce and brassicas grown in small cells under optimal environmental conditions, and up to ten weeks or more for slower-growing species such as peppers, and alliums grown under less than perfect conditions or when producing larger transplants for field production

The process of cycling plants from your most precise environmental control during germination and early development, through seedling maturation and the process of hardening off will be explained in greater detail in Lecture 2

D. Qualities/Characteristics of Seedlings Ready for Transplanting

1. Seedlings ready for transplant ideally should have:
 - a) A root system and root knit sufficient to hold together soil surrounding the roots
 - b) At least two sets of well-developed true leaves, true to color for the species
 - c) Cycled through the process of “hardening off,” whereby seedlings have been exposed to outdoor conditions similar to their eventual in-ground growing environment for at least several days, including full exposure to day-night temperature fluctuations to help build carbohydrate reserves, and full exposure to the wind and sun to strengthen cell walls and enhance tolerance to future the extremes in growing conditions
2. Holding: Maintaining seedling quality when transplanting is delayed
 - a) At times, transplanting may be delayed and it may not be possible to transplant seedlings when they are at their optimal stage of development. This could occur:
 - i. When excessive rains prevent cultivating and preparing the soil
 - ii. When inadequate rain means it is too dry to prepare the soil without degrading soil structure and you must wait for rain or pre-irrigate
 - iii. In cases of succession planting, when the ground for your new seedlings is still occupied by a crop that has not yet matured
 - iv. When you are unable to prioritize new plantings due to other seasonal demands
 - b) There are several ways to keep your plants in good condition until you are ready to transplant:
 - i. Know which crops tolerate holding and delays in planting and which do not. For those that do not hold well, prioritize their planting whenever possible:
 - Cucurbits, heading brassicas, bulbing onions, and peppers, for example, typically do not respond well to holding
 - Leeks, tomatoes, collards, and kale are all crops that can be held well, both responding to holding strategies and rebounding well once transplanted
 - ii. Provide supplemental fertility to compensate for the nutrients that may no longer be available in your soil mix. As seedlings use up available nutrients, growth will invariably slow—supplemental fertility can address this issue.
 - iii. Move seedlings into a cooler location or microclimate to slow the rate of growth
 - iv. Move seedlings into partial shade to reduce photosynthesis and slow growth. Note that plants may need to be hardened off again if they are held in shade for an extended period in order to prepare them for garden and field conditions.

Lecture 2: Managing Environmental Conditions—Using Greenhouses to Optimize Seedling Production

A. Optimizing Germination, Seedling Development, and Seedling Maturation

The principal role and function of greenhouse facilities is to modify or manage environmental conditions to optimize plant health and development. Although greenhouse structures serve many purposes, from producing transplants, to in-ground production of high value crops, to early and late season extension in a range of climates, this lecture focuses on using greenhouse facilities for seedling production.

1. Optimizing **germination**: Propagation structures, combined with the knowledge and experience of the greenhouse grower, can be managed to create optimal environmental conditions (e.g., temperature, air circulation, light, and soil medium moisture) that facilitate rapid germination and early crop establishment
 - a) To promote rapid germination, temperatures must be maintained within the appropriate range for chosen crops (see Appendix 3, Soil Temperature Conditions for Vegetable Seed Germination). Temperatures below the optimal range will either delay germination or promote erratic germination, and thus inconsistent seedling age. Temperatures above the optimal range can induce thermo-dormancy in some crops, such as lettuce and spinach, preventing or delaying germination. Temperatures within the optimal range will promote rapid, uniform germination and consistent early development.
 - b) Consistent air circulation is critical for crop health, both to provide adequate oxygen for respiration and to mitigate against presence of fungal pathogens/"damping off" organisms, which thrive with consistent soil moisture and stagnant air conditions
 - c) With recently sown seed and germinating seedlings, moisture delivery is typically frequent and shallow. Consistent delivery, combined with high quality soil media, prevents desiccation of imbibed seeds and emerging root radicals. However, a moderate wet-to-dry swing in surface soil conditions, especially once crops have germinated, is critical to prevent the presence and proliferation of damping off organisms.
 - i. *Pythium*, *Rhizoctonia*, *Fusarium* and *Phytophthora*, the primary genera of fungal pathogens known as "damping off" organisms, can be controlled by managing environmental and cultural conditions: Allowing for a wet-to-dry swing between waterings, preventing stagnant air in the greenhouse, promoting consistent airflow, and when necessary, managing for temperatures that limit pathogen proliferation
2. Promoting healthy **early seedling development**: Ongoing management of environmental conditions (temperature, air circulation, and moisture delivery) is required as seedlings develop, but with most species, seedlings' physiological tolerance expands and precise environmental control may be less necessary to maintain optimal development. When greenhouse space is at a premium, young seedlings are typically moved to alternative structures (from a greenhouse to a hoop house, for example) to make way for the next generation of crops most dependent on precise environmental control.
 - a) Temperature management remains critical, especially when trying to extend seasonal parameters. Growing in the protected/moderated environment of the greenhouse or hoop house will promote more rapid development than normally possible outdoors by creating more favorable daytime conditions and minimizing nighttime chilling of crops and soils, which will slow the resumption of growth the following day.

Note: Optimal temperatures for germination and subsequent growth differ for some crops (e.g., Brassicas) and thus germination might be optimized in a greenhouse, while seedling growth might be best in a hoophouse or outdoors, depending on your growing environment (contrast Appendix 3 with Appendix 5, Approximate Monthly Temperatures for Best Growth and Quality of Vegetable Crops)

- b) Maintaining good air circulation continues to be important in order to manage temperatures, prevent diseases, and promote strong structural/cellular development
 - c) As seedlings develop, irrigation frequency typically decreases, but the depth/volume of water delivered at each irrigation increases to support the expanding root system and leaf canopy, and the increased transpiration rate. Reduced frequency and the resultant wet/dry swing help prevent damping off damage and promote the beginnings of drought tolerance as crops adapt to cope with short-term moisture limitations.
 - d) Sunlight is critical for developing seedlings to manufacture nutrients through photosynthesis and to promote strong cellular growth and compact architecture. While germination can take place in the absence of sunlight, for example in a growth chamber (see below), healthy seedling development depends on adequate sunlight; otherwise, crops will be weak and “leggy,” and thus less able to withstand the more variable conditions encountered in the ground. In the hottest climates, full sun exposure can cause tip burning and seedlings may require some shading, but eventually they will need full exposure to prepare for in-ground life.
3. Managing **seedling maturation and hardening off**: Mature seedlings will typically have a balance of root and shoot growth—at least two sets of true leaves and an ample root system that holds together the root ball when removed from the growing container. “Hardening off” is the final step in preparing seedlings for transplant and uninterrupted growth. In the final 3–10 days in the greenhouse zone, seedlings should be outdoors and exposed to conditions that most closely resemble their future home in the ground. This acclimatization process reduces transplant shock, which can occur when seedlings experience an abrupt transition from the protected environment of the greenhouse to the less predictable conditions of a garden or field setting. During the hardening off process, the following developments occur, which better enable plants to transition seamlessly to their new homes in the ground:
- a) Full exposure to natural day-night temperature fluctuation promotes a buildup of carbohydrate reserves. When transplanted, reserves provide seedlings with a nutrient buffer while they develop new roots to tap into soil resources.
 - b) Full exposure to stronger air circulation and prevailing wind patterns promotes cell walls thickening, improving transplants’ ability to withstand the vagaries of the outdoor environment
 - c) As plants approach seedling maturity, water is typically delivered less frequently, but in greater volume
 - i. Reduced irrigation frequency supports the hardening off process and plants’ transition into the ground. Once in the field, seedlings normally must be able to withstand longer periods between irrigations.
 - ii. Consistently providing water to the depth of the containers facilitates root development and nutrient access across the full volume of soil available to seedlings, thus maximizing development potential
 - d) Exposure to full sunlight, equivalent to future in-ground exposure, aids maturing seedlings in cell development, cell wall strengthening and enhanced photosynthesis. As with the benefits of the above-mentioned treatments, seedling exposure to full sun conditions is another aid in reducing the potential for transplant shock.

B. Passive and Active Environmental Management: A Brief Overview

The methods and tools used to manage environmental conditions in greenhouses normally fall into one of two broad categories: Passive or active. Here we briefly describe these categories; see Lecture 3, Greenhouse Heating, Cooling, Lighting, Irrigation, and Climate Control Systems, for a more detailed discussion.

1. Passive methods of environmental control are part of the functional design of most greenhouses and represent a low-tech approach that does not involve the ongoing use of energy to regulate conditions. They include:
 - a) Heating by the capture of solar radiation as sunlight passes through the greenhouse glazing and warms the interior air
 - b) Cooling via side and end wall vents that draw in cooler air from outside and ridge vents at the top of the greenhouse that allow the heated air to be exhausted out of the structure. Shade cloth or whitewash can also be used to help cool the greenhouse.
 - c) Air circulation via the venting system. As with cooling, exterior air enters the structure through open side and end wall vents, and the air already in the greenhouse exits primarily through ridge vents and vents placed high on end walls.
 - d) Irrigation can be delivered by hand or by overhead spray systems.
 - e) Lighting comes exclusively from sunlight. Light reduction via whitewashing and the use of shade cloth is another form of passive management.
 - f) Additional physical methods to heat and cool the greenhouse include the use of shade cloth, white washing, and energy curtains

2. Active Methods

Active environmental controls use an external energy source to power heating, cooling, venting, supplemental lighting, irrigation, and climate control systems. Active control mechanisms are not a substitute for passive methods, but rather are complimentary tools that allow growers to more precisely and predictably create desired conditions. Active methods include:

- a) Heating via conduction (direct contact with heating source), convection (via warm air circulation), and radiant heat sources
- b) Cooling via evaporative mechanisms (pad and fan systems), swamp coolers, and fog systems
- c) Air circulation via exhaust and horizontal airflow fans
- d) Supplemental lighting, including incandescent, fluorescent, high intensity discharge, and high pressure sodium lights
- e) Automated irrigation systems, including overhead sprinklers
- f) Thermostats, stage controllers, and computer-directed environmental controls that monitor and control various heating, cooling, circulation, lighting, and irrigation systems

C. Environmental Control in Different Types of Propagation Structures

1. **Passive Solar Greenhouse:** Good environmental control is possible in relatively low-tech facilities, especially in milder climates where growers do not face extremely hot or cold conditions. As described above, these greenhouses rely on passive techniques (see also Supplement 1, Examples of Daily Warm- and Cool-Season Greenhouse Management Practices in a Passive Solar Greenhouse).
 - a) Trap solar radiation to warm the air and thus the crops
 - b) Cooled through the use of venting systems: Combination of end wall vents, roll up/down sides, and ridge vents, to draw in cooler external air, and exhaust warmer internal air

- c) Air circulated by manual control of inlet and outlet venting; complements the heating and cooling capacity of passive solar design
 - d) Moisture regulation/delivery managed by the grower through manual/hand delivery, semi-automated, or automated delivery systems
 - e) Microclimatic heating may be possible; offers additional environmental control when power is available to supply the system, but this goes beyond the purely passive
2. **Enclosed (semi) Automated Greenhouses:** Precise environmental control achievable via active mechanisms:
- a) Characterized by ability to fully close growing environment, regulate temperatures/air circulation through passive and active venting and fan-driven air movement, heating/cooling by fans, furnaces, swamp coolers, etc. (see Lecture 3 for details)
 - b) The interplay of environmental conditions and sophistication of active management tools dictate the precision of environmental control: More precise control comes with more responsive systems and lesser extremes in conditions to be regulated
 - c) Trapped solar radiation works in concert with active heating mechanisms to create desired warmth
 - d) Cooling via passive venting systems works in concert with active cooling mechanisms to create desired temperatures
 - e) Microclimatic heating in root zone via hot water pipes or electric cables is often used to optimize conditions and speed the rate of plant growth
 - f) Automated or manually controlled sprinkler systems are the norm in more actively managed and infrastructure-intensive greenhouses, but spot watering by hand remains critical to optimize plant health
3. **Open Hoop Houses/Quonset Huts:** Can partially modify environmental conditions and improve plant health, especially in milder climates
- a) Temperature modification: Umbrella-like coverage creates slightly warmer day and night conditions, which favors more rapid development than possible outdoors
 - b) Provide some buffering against effects of wind, though air circulation may be limited by how structure is located relative to prevailing winds, nearby windbreaks, and other structures, unless the hoop house is outfitted with roll up or roll down sides and end wall venting
 - c) Grower controls moisture regulation, delivering necessary irrigation through same means as in greenhouses
 - d) Can be used as an intermediate step between greenhouse and outdoors: Greater exposure of plants to wind and day-night temperature fluctuations offers a gradual step in the hardening off process, especially when the favorable conditions created in the greenhouse are dramatically different than prevailing outdoor conditions
4. **Germination Chambers:** Small-scale, self-contained facilities that provide optimal control over temperature and humidity to facilitate rapid, high-percentage germination
- a) Whether pre-assembled or home made, chambers are comprised of a water-holding pan, a submersible heat source with variable temperature control, a water supply, insulated walls, suitable shelving to hold propagation trays, and doors large enough to easily move containers in and out of the chamber. Units usually hold between 24–48 propagation trays but can be designed larger or smaller to meet needs.
 - b) Together, these elements create an energy efficient, very consistent environment for germination where humidity and temperature can be optimized to greatly improve and speed germination

- c) Rapid germination in chamber's compact space can save growers significant heating or cooling costs, depending on the season
 - d) Higher percent germination can reduce seed costs
 - e) Must be regularly monitored: Once seedlings germinate, propagation trays must immediately be removed from the darkness of the chamber and moved to a sunny location to facilitate normal cell development and photosynthesis
5. **Cold Frames:** Small-scale, low-tech structures used to modify environmental conditions. Similar to passive solar greenhouses and hoop houses that do not contain any supplemental infrastructure.
- a) Simple structures, normally placed directly on the ground, consisting of four low walls (insulated in colder climates) and a sloping, hinged roof that allows in sunlight for warmth and photosynthesis. Roof can be opened to facilitate cooling and air circulation.
 - b) Often built of recycled materials, such as wood and rigid insulation board for siding and old windowpanes or clear acrylic panels salvaged from local resource recovery facilities for the roof
 - c) Sunlight can quickly heat internal air and enclosed air mass will provide some buffer against cold nighttime temperatures; due to small size, cold frames provide limited buffering capacity and are prone to rapid temperature shifts as external temperatures change
 - d) Cooling and air circulation are achieved through opening the roof. Relying on this passive exchange, while effective, can be problematic if the cold frame is left closed for too long during warm conditions.
 - e) Irrigation is usually done by hand and can provide a secondary form of cooling through evaporation
 - f) Through greater venting or leaving a cold frame open overnight, increased air flow and day-night temperature fluctuation can help initiate hardening off
6. **Outdoor Benches:** In most growing environments, seedling maturation or hardening off is completed by placing seedlings outdoors on benches, exposing plants to conditions that closely approximate the in-ground environment they are moving toward. As detailed above, full exposure to sunlight, wind, and temperature swings stimulates carbohydrate reserve buildup and strengthens cell walls so that plants can withstand the vagaries of the in-field environment.
7. **Shade Structures:** While most annual vegetable seedlings require full sun to optimize growth, shade cloth may be needed in hotter climates to prevent soil media from drying out so rapidly that the grower must constantly devote time and water to keep young seedlings healthy

D. Irrigation Management and Delivery

1. Greenhouse irrigation concepts and terminology are similar to those used in the garden and field setting (see Unit 1.5, Irrigation—Principles and Practices). However, because of the small soil volumes plants are growing in and because of the design of propagation and nursery containers, water behavior in greenhouse containers and consequent practices can be quite different.
 - a) **Saturation:** As with field soils, saturation in containers comes at the point when irrigation water fills all of the pore space in the soil medium, but in high quality mixes, this is only a very temporary state and excess moisture quickly drains from the mix
 - b) **Container Capacity:** Similar to Field Capacity, container capacity is when excess water has drained, air has returned to part of the pore space, and maximum water is held in the pore spaces against the forces of gravity

- c) Percent Container Capacity describes the relative availability of water in the mix as water is lost to uptake by the plant roots and evaporation
- d) Perched Water Table describes the water that is held at the bottom of flat-bottomed containers. This condition may be detrimental to plant health if the soil mix does not contain an adequate amount of coarse materials to promote good aeration throughout the root zone.
- e) Percent Surface Dry Down is another important concept in the greenhouse setting, and applies specifically to the germination phase of seedling production when frequent but small quantities of water must be delivered to facilitate germination and prevent desiccation of newly emerging roots
 - i. For the vast majority of seed-grown crops, a small quantity of water should be re-applied when somewhere between 30–50% of the visible soil surface has dried down
 - ii. For larger-seeded crops such as sunflowers and members of the cucurbit family, growers typically allow 100% of the surface soil to dry down before re-applying moisture
- f) Post germination: Greenhouse growers deliver water in direct response to crops needs, the age and stage of development of their crops, and the immediate and anticipated environmental conditions that crops are experiencing

E. Pests and Pathogens in Propagation Facilities

1. Management program begins prior to propagation with preventive measures, identifying and eliminating the possibility of contamination
 - a) The propagation facilities: Greenhouse structures, greenhouse floors, pots, flats, hand tools, hoses, benches, etc. can all harbor plant pathogens. Good sanitation programs should include periodic cleaning or disinfecting of all materials and facilities.
 - b) Propagation media can be another source of contamination, especially for soil borne bacteria/fungi and weed seeds (see Lecture 4, Soil Media, Fertility, and Container Formats). To minimize this risk, growers can:
 - i. Use biologically active, disease-suppressing media based on high quality composts, and/or inoculated with beneficial fungi or mycorrhizae
 - ii. Use sterile, soilless media that comes from sterile sources, lacks biological potential, or has been previously treated to eliminate pathogens
 - iii. Use heat/steam and solar pasteurization methods to sterilize media, a costly but effective method that will eliminate pathogens and beneficial organisms simultaneously
 - c) Seed/plant stock can also be a source of contamination. The grower can protect against this potential by:
 - i. Using seed/propagule material that comes from reliable sources and is certified to be pest and disease free
 - ii. Using seed pre-treatment techniques such as hot water baths to kill fungi and other pathogens
 - d) Exclude pests from growing environment
 - i. Screen at all points of entry into the greenhouse, including vents, fans, and doorways
 - ii. Use floating row covers over cell trays to keep flying insect pests off of emerging crops
 - iii. Use physical barriers such as water basins or sticky resins on table legs to prevent ants and other crawling insects from having access to young crops

2. Good cultural practices are a critical component in the management/prevention of pest/disease challenges
 - a) Select pest- and disease-resistant varieties and avoid crops vulnerable to known potential problems. Check with local growers and extension agents for issues common in your area for the crops you grow.
 - b) Grow crops at appropriate seasonal junctures, where environmental conditions naturally facilitate healthy, vigorous, pest- and disease-resistant growth
 - c) Manage environmental conditions to mitigate against the presence of pests/disease and promote vigorous, uninterrupted growth. This includes the management of:
 - i. **Temperature:** Especially important in the prevention of damping off organisms, which thrive when soils are constantly moist and temperatures are steadily in the 68°F to 86°F range. While this range is both ideal for damping off organisms and for the growth of many common crops, damping off damage can be prevented by using high quality soil media, making sure the soil goes through adequate wet to dry swings, and sacrificing optimal temperatures when cooling will control damping off fungi.
 - ii. **Moisture:** The quantity and frequency of moisture delivery is critical to healthy seedling development. Constantly wet soil deprives roots of necessary oxygen, limits the mobilization of organic nutrients in the soil mix, and can create conditions that favor damping off and root rotting fungi. Excess irrigation can also lead to nutrient leaching from the soil media, depriving plants of valuable resources and potentially compromising local surface or groundwater quality (see Supplement 2, Conserving Water and Protecting Water Quality).
 - iii. **Air circulation:** Circulation or oxygen exchange within the greenhouse, as previously highlighted, helps regulate greenhouse temperatures, is critical in promoting strong cells and healthy growth, and prevents pathogen buildup
 - iv. **Fertility:** In concert with other cultural practices, adequate but not excessive soil fertility promotes healthy, uninterrupted growth. Excess fertility can lead to lush, rangy growth and attract aphids and other insects that feed on nitrogen rich crops (see Appendix 6, Sample Soil Mix Recipes, for examples of mixes with appropriate fertility).
3. Management also includes monitoring and early detection of pest/disease problems to minimize crop loss and need for intervention
 - a) Monitor at regular frequency: Make close observations to look for early signs of disease and pest presence; use yellow or blue sticky traps to sample for and or control flying insects such as shore flies and fungus gnats
 - b) Use pest and disease identification tools such as the books and websites listed in the Resources section of this unit (see also Unit 1.8, Managing Arthropod Pests and Unit 1.9, Managing Plant Pathogens). These resources can help with understanding life cycles, seasonal and environmental conditions that favor pests and pathogens, cultural strategies that can prevent or minimize problems, and in some cases, suggest organically approved inputs to use when intervention is necessary.
 - c) Establish clear tolerance thresholds to initiate control actions, when shifts in cultural practices and environmental management does not provide adequate controls
 - d) Rogue (cull), or quarantine infected crops to prevent the spread of problems to nearby crops susceptible to the same pests or diseases. Roguing requires sacrificing some for the good of the whole. Quarantining allows treatment strategies to be applied selectively and in isolation from other susceptible crops, thus reducing the likelihood of more widespread outbreaks.

- e) As a last resort, use organically acceptable chemical controls, or biological control agents that specifically and selectively target the pest or disease problem you are trying to manage. Following as many as possible of the above strategies and intervening early can greatly reduce losses and increase the efficacy of the inputs organic growers have at their disposal.
- f) While most greenhouse pests and pathogens are common across the country because of the similarity of environmental conditions created in greenhouses, speak with local growers, cooperative extension agents, and IPM practitioners to find out what problems to anticipate in your region, which crops may be most vulnerable, the potential severity of particular pests and pathogens, and the times of year to be especially vigilant

Lecture 3: Greenhouse Heating, Cooling, Lighting, Irrigation, & Climate Control Systems

A. Passive and Active Environmental Management

As discussed briefly in Lecture 2, passive and active methods are the two general categories of techniques used to manage environmental conditions in greenhouses

1. Passive methods

Passive methods are part of the functional design of most greenhouse structures and represent a low-tech approach that does not involve the ongoing use of energy to regulate conditions

- a) Heating is achieved by the natural capture or trapping of solar radiation as sunlight passes through the greenhouse glazing and warms the air within the structure. The extent to which you can heat or even overheat a greenhouse solely through trapped solar radiation depends on your regional climate, how the greenhouse is situated relative to other buildings, trees, etc., and the aspect or slope orientation of the site.
- b) Double Wall Glazing: Double wall polycarbonate roofing and double layers of polyethylene film held aloft by fans can provide a measure of insulation and a buffer against rapid temperature swings
- c) Internal Curtains: Retractable by day to maximize light infiltration and deployed at night, modern curtains reflect heat back into the greenhouse and further buffer crops against nighttime low temperatures
- d) Cooling occurs principally through the use of side and end wall vents that draw in cooler air from outside of the greenhouse, and by vents located along the ridgeline that allow the heated air to escape. The capacity to cool greenhouses solely by passive means is partly a function of structural design, but is largely determined by local climate conditions, exposure to prevailing winds, and the intensity of sunlight heating the house. When it is 90°F outside, an unvented greenhouse can easily rise to 130°F. Even with early, preventive venting, it can be difficult to keep interior temperatures below 100°F.
- e) Some cooling can be achieved by covering structures with shade cloth or whitewashing to reflect solar radiation, but the efficacy of these methods is again dictated by local climate. This also reduces light transmission, which can negatively impact crop performance, slowing growth rates, creating weaker, leggy plants and softer, more tender tissue.
- f) Air circulation occurs exclusively via the design, functionality, and deployment of the venting system. As with cooling, exterior air enters the structure through side and end wall vents; the air already in the greenhouse exits primarily via ridge vents and vents placed high on end walls. Despite a lack of active mechanisms (fans, blowers, etc.) to exchange air, the side, end wall, and ridge vents sized appropriately for the structure, can effectively promote air circulation and exchange. This can be a vital tool in limiting the presence of disease pathogens, as discussed in Lecture 2.
- g) Irrigation in passive structures can be delivered by hand or by overhead spray systems. The greenhouse manager must make ongoing, real time decisions to determine when and how much water to apply to what crops.
- h) Lighting in passive structures comes exclusively from the sun and is dictated by your regional climate, how the greenhouse is situated relative to other buildings, trees, etc., and the aspect or slope orientation of the site. Light reduction via whitewashing and shade cloth is another form of passive management.

2. Active methods

Active methods are also part of the functional design of greenhouse structures, but use an external energy source to power mechanisms that enhance the greenhouse grower's ability to more precisely manage temperatures, air circulation, and water delivery

- a) Active environmental controls inherently drive up construction costs because additional mechanisms must be purchased and installed. In many climates, and for some crops, these tools are critical to achieve appropriate environmental control. Over time, increased labor efficiency and improved crop performance can make up for upfront costs.
- b) Active control mechanisms are not a substitute for passive methods, but rather, are complimentary tools that allow growers to more precisely and predictably create desired conditions
- c) Design considerations are based on how hot or cold your climate gets, combined with the desired temperature ranges for the crops you grow. These will determine the importance of and type of heating and cooling infrastructure to incorporate into greenhouse design.

B. Principle Heating and Cooling Mechanisms

1. Active/Supplemental Heating can be delivered to the greenhouse environment several ways:

- a) **Conduction:** Conductive heating occurs when growing containers are in direct contact with the heat source. Heat is transferred from the source to the soil media and then to the plant roots and canopy. Electric heat mats, benchtop hot water piping, and radiant floors are all examples of conductive heating.
- b) **Convection:** Convective heating occurs when warmed air is moved around plants via fans or other means of air circulation, transferring warmth to the soil and crop. Unit heaters and perimeter fin/pipe systems, combined with fans, are examples of convective heating.
- c) **Radiation:** Radiant heating occurs by way of infrared waves transferring heat energy to the crops. This takes place when crops are placed close to the heat source, such as when growers install hot water piping under benches, and for the crops closest to perimeter fin/pipe systems. Most mechanical heat sources actually deliver a combination of radiant and convective heat.

3. Heating mechanisms

- a) Unit heaters, functioning by convection, are normally suspended from the upper structure of the greenhouse, and can be gas or electric powered, depending on available energy sources and costs. A unit heater consists of a heating element/fuel combustion chamber and fans to move the heat from the source through the greenhouse. In larger greenhouses and in colder climates, growers use multiple unit heaters and/or perforated duct systems to more uniformly distribute heat.
- b) Hot water systems, such as the perimeter fin/pipe, and under-bench hot water piping, heat the air of the greenhouse, which then radiates and is moved by convection to the containers/soil and crops. These systems can be powered by natural gas, propane, oil, wood waste, geothermal, or solar batch collectors, depending on resource availability and costs.

- c) Micro-climate heating: In the form of bottom heat, whether electric mats or hot water tubing directly on the bench tops, can be the most energy efficient because the grower does not necessarily strive to heat the air of the entire greenhouse, but rather the soil/ root zone and by extension the leaf canopy through conduction. Heat mats are normally electric, must be plugged in to a power source and generally are used for smaller-scale operations. Closed loop, bottom heat hot water tubing, such as the Biotherm system, can be powered by electricity, gas, or be connected to a solar hot water system to efficiently heat the root zone. This type of system can be particularly useful for heat-loving crops such as Solanums and Cucurbits.

4. Cooling mechanisms

Cooling mechanisms are required for summer greenhouse production in all but the mildest environments. In virtually all other growing environments, trapped solar radiation can create an environment too hot for most seedlings. The importance of active cooling mechanisms cannot be overstated unless you are only producing heat-loving crops.

Depending on the crops you grow, the size of your facilities, and the nature of your climate, different cooling mechanisms may be available to you

a) Evaporative Cooling

- i. Fan and pad systems combined with exhaust fans are commonly used in actively managed commercial greenhouses
 - Fan and pad systems are electrically powered and are made up of corrugated cellulose pads housed on one wall of the greenhouse. A water reservoir and pump system saturates the pads, and a fan evaporates the water in the saturated pads. Air coming into the greenhouse is cooled via the heat energy absorbed as the water evaporates.
 - Fan and pad systems, combined with exhaust fans, must be appropriately sized for the greenhouse structure, and the environmental conditions that need modification
 - These systems work most efficiently in drier climates; in high humidity environments, systems should be over engineered by approximately 20% to compensate for the inefficiency of evaporative cooling in already water-saturated air
 - While highly effective, fan and pad systems can be costly to operate during peak electricity rate periods, which coincide with the times/conditions when the systems are most needed
 - Typical fan and pad systems operate at about 85% efficiency and have a temperature differential of as much as 7–10°F because cooling is centralized at the fan and pad, and depends on the fans and exhaust system for distribution across the structure
- b) Swamp coolers work on the same principle as fan and pad systems, but are usually installed in smaller structures, often without active exhaust fans. Instead, the evaporatively cooled air is moved across the structure by strong fans within the swamp cooler; warmed air exits the structure passively through ridge and end wall venting.
- c) Fog systems also work on the same evaporative cooling principles, but distribute fog across the entire greenhouse through careful placement of atomizing nozzles
 - i. Results in nearly 100% cooling efficiency, with temperature differentials at no more than 1°F
 - ii. Can be used in greenhouses with only natural ventilation and/or mechanical ventilation
 - iii. Operate under high pressure, with water forced through very fine-aperture fog nozzles. Clean water and regular maintenance are required to keep the systems operating properly.

5. Physical methods for heating and cooling

Additional heating efficiency and cooling can be achieved through physical/mechanical means such as the use of shade cloth, white washing, and energy curtains

- a) Shade cloth can be purchased in a range of shade densities and can be installed on the interior or exterior of the greenhouse. Shade cloth reduces light intensity and thus heat from solar radiation. Relatively inexpensive materials can provide years of service and reduced cooling costs. However, excess shade for sun-loving crops can lead to weak, leggy growth that will be more vulnerable to pests and to damage by winds and frosts when transplanted.
- b) White washing, a traditional method of reducing light intensity and temperatures, reflects solar energy away from the greenhouse, thus reducing interior heat and the need for cooling. Very inexpensive, but must be removed in the winter months to improve solar heating potential and reapplied the following season. As with shade cloth, reduced light levels can lead to weak, leggy growth in some crops.
- c) Energy curtains, are the most expensive but most versatile of these physical/mechanical tools. Energy curtains are retractable coverings, made of either plastics or aluminized polyesters. When deployed, they trap an insulating layer of air between the crops and the greenhouse roofing; they reduce the total volume of air that must be heated to satisfy crop requirements and the metallic fabrics heat energy back into the crop zone. Additionally, on hot, sunny days, they can be deployed to act as a shade barrier, thus reducing greenhouse temperatures and the need for additional cooling. Energy curtains can cost several dollars per square foot to purchase and install, but with every rising energy costs, the improved energy efficiency they provide can be recouped in as little as two to three years.

C. Air Circulation

1. Active air circulation moves cooler exterior air into the greenhouse to keep temperatures down. Simultaneously, air movement induces evaporative cooling when plants respire and when humidity in the air evaporates and absorbs local heat energy.
 - a) Exhaust fans should be sized according to your climate, crop needs, and the size of the structure requiring ventilation
 - i. Propeller-type exhaust fans should be large enough to exchange the entire interior air volume in just one minute. While this might sound extreme, this is the standard for active ventilation and can normally prevent interior air from being more than 10°F above exterior temperatures.
 - ii. Inlet vents and pad and fan type cooling systems are normally positioned on the windward side of the greenhouse to maximize the potential for the movement of exterior air into the greenhouse
 - iii. Exhaust fans are normally positioned on the leeward side of the greenhouse to maximize their potential to move heated air out of the structure
 - b) Horizontal Air Flow (HAF) Fans, are usually 1-3" in diameter and are attached to the greenhouse structure at the height of the top of the side walls
 - i. HAF fans serve to provide consistent air circulation even when the greenhouse is tightly closed to retain internal heat
 - ii. HAF fans help reduce excess humidity in the greenhouse, especially when condensation builds up over night, helping reduce the incidence of fungal issues
 - iii. HAF fans are normally suspended no more than 50-80" apart and work best when positioned so that fans on opposite sides of the greenhouse are blowing air in opposite directions, thus creating a circular movement pattern
 - iv. HAF fans add little extra air movement beyond what passive and active air circulation systems provide and are not normally powered on when venting and fans are in use

D. Supplemental Lighting

Lighting systems that supplement available sunlight can increase crop productivity and quality

1. Can improve plant growth in low light and short day length conditions, e.g., during winter in northern climates
2. Can manipulate photoperiod, and bring day length-sensitive crops to bloom out of their normal cycle and thus have crops such as sunflowers blooming year round
3. Benefits must be weighed against the cost of purchasing and installing supplemental lighting, as well as ongoing energy costs. Careful Return on Investment (ROI) calculations should be made prior to purchasing any supplemental lighting to see if the initial expense and ongoing costs can be justified by yields.
4. Incandescent and fluorescent lighting are the least expensive options but are only effective in impacting day length sensitivity, and will not improve quality of growth
5. High Intensity Discharge (HID) and High Pressure Sodium (HPS) lighting units are required if growers need to increase available light to improve plant growth. These are more expensive to purchase and operate. If you are growing photoperiod-sensitive crops in low light and short day length regions, then HID and HPS lighting can be used both to impact day length and the quality of crop growth.

E. Irrigation Systems

1. Manual irrigation

Hand delivery requires the lowest amount of capital investment. One only needs a water source, faucets, hoses, and tools such as a Fogg-It nozzle, the "rose on a hose," or a wand and water breaker combination to deliver water across the seedling life cycle. However, relying exclusively on hand watering is very labor intensive and can lead to uneven plant performance unless water is being delivered by a highly skilled irrigator.

2. Overhead delivery via semi-automated and automated sprinkler systems

A well designed sprinkler system can uniformly deliver water to an entire crop with very little time/labor required

- a) In semi-automated systems, typically the grower must assess plant/soil needs and then determine when and how much water to apply. However, using mechanical timers to semi-automate the system, delivery and shut off are provided by the timer and overhead sprinkler system.
- b) In fully automated systems, environmental sensors and computer-driven programming are synchronized to respond to current environmental conditions and the needs of developing seedlings. While much more costly to set up, well-designed automated systems typically have a rapid return on investment, due to improved crop quality and huge savings in labor.
- c) Because of the "edge effects" of increased sun exposure and air circulation, plants at the edges of benches and blocks will normally dry out faster than those in the interior, so even automated and semi-automated systems usually require some hand watering follow up. Even with this limitation, the labor savings such systems offer is immense and can pay for the cost of investment in a single season.

F. Automated and Semi-Automated Climate Control Infrastructure

1. **Thermostats** are the least expensive and unfortunately least accurate environmental management tools available for automation
 - a) Thermostats are positioned in the greenhouse to turn heating and cooling equipment on at pre-determined temperature thresholds, based on your climate and crop needs
 - b) Older thermostats, while convenient, are notoriously inaccurate and may not give the precise control desired. Additionally, separate thermostats are required to control heating and cooling equipment.
 - c) Modern thermostats, while more expensive, offer more accurate control by using digital or electronic technology to monitor temperatures and operate environmental control equipment
2. Stage controllers offer dramatic improvement in precision of environmental control by linking the operation of heating and cooling devices, air circulation mechanisms, and even the deployment of energy curtains and shade cloth in the higher-end models
 - a) Stage controllers typically provide one or two set points to activate the heating mechanisms in your greenhouse and three, four, or more stages of activation of the cooling mechanisms
 - i. For example, as the greenhouse heats beyond a given threshold, at stage one vents will open
 - ii. With continued heating, vents and fans will operate
 - iii. And with further heating, the pad and fan cooling system will be activated to maintain the desired temperature
 - b) Stage controllers are only limited by the range of set points that activate your heating and cooling mechanisms; higher-end models may also offer a data recording feature
3. Computer directed environmental controls offer the maximum level of precision in the total environmental control of the greenhouse
 - a) Computer zone controllers, with or without a PC, links all aspects of environmental control—temperature, air circulation, water delivery, and lighting—through a single device, offering a high degree of flexibility and the ability to customize the system
 - b) Integrated computer systems, using a PC, also provide maximum control of all aspects of environmental conditions, with the added advantage of being able to control multiple zones or separate structures from a single device. The most sophisticated systems offer remote access through smart phones, tablets, and laptops, as well as the ability to receive alarm warnings whenever conditions are out of the desired range or components are malfunctioning.

Lecture 4: Soil Media, Fertility, & Container Formats

A. Soil Media and Plant Propagation

1. Role of propagation media
 - a) Whether purchased or made on farm, soil mixes for propagation and seedling production are designed to provide an idealized growing environment by:
 - i. Providing a readily available nutrient supply to support steady, healthy plant growth
 - ii. Holding/retaining adequate moisture to meet plant needs without the need for constant watering
 - iii. Allowing excess water to drain rapidly from the media. This prevents or limits the presence of fungal pathogens and thus allows for proper aeration in the pore space to promote healthy root development.
 - iv. Providing an environment for root anchorage and development
 - v. Being free of pathogens and weed seeds, which could compromise crop growth
 - b) **Nutrients** are primarily supplied in organic soil mixes by:
 - i. Compost: Source of moderate quantities of NPK, and micronutrients
 - ii. Soil: Field-based soils can provide NPK and micronutrients in small quantities
 - iii. Organically derived amendments and byproducts: Such as blood meal (13-0-0), bone meal (4-14-0), cottonseed meal (5-2-1), feathermeal (12-0-0), fish meal (9-3-0), soybean meal (7-2-1)
 - iv. Mineral amendments: Such as dolomite (Ca, Mg), greensand (K), rock dusts (Ca, Mg, micronutrients), sulphate of potash (K, S), soft rock phosphate (P, Ca, micronutrients)
 - c) **Moisture retention** in soil media is achieved through the use of:
 - i. Composts
 - ii. Peat moss
 - iii. Coco Peat/Coir Fiber
 - iv. Vermiculite
 - v. Leaf mold
 - vi. To a lesser extent, moisture retention also provided by soil, sand, perlite
 - d) **Adequate drainage** in soil mixes is primarily provided by:
 - i. Coarse sand
 - ii. Perlite
 - iii. To a lesser extent, drainage is also provided by compost, vermiculite, peat moss, coco peat, leaf mold (partially decomposed leaf litter), and partially decomposed wood byproducts
 - e) Growing media must also provide **aeration**, allowing soil pore spaces to exchange O₂ and CO₂. This is accomplished through the use of:
 - i. Perlite
 - ii. Sand
 - iii. Vermiculite
 - iv. Leaf mold
 - v. To a lesser extent by peat, coir fiber, and coarse composts
 - f) Soil media should be **pathogen-free** and by the nature of its composition and careful cultural practices, should not be conducive to the development of pathogens

B. Properties and Considerations of Principle Soil Media Ingredients

1. Composts

- a) Can be an excellent source of short- and long-term nutrient availability, provide moisture-holding capacity, are a source of bulk density, and provide some degree of drainage and aeration
- b) Can be produced on farm, are a way to use animal residues and recycle on-farm nutrients
- c) Can be a source of beneficial bacteria and fungi that promote plant health
- d) Can also be the source of weed seeds and pathogens if not from a well-managed, high quality source
- e) Similarly, if not made from nutrient-rich sources or if too old, they can be a poor source of nutrients

2. Field and garden soils

- a) Assuming they are well managed sources, can be a decent source of macro and micro nutrients
- b) Can be a source of beneficial bacteria and fungi
- c) Can provide valuable bulk density but at the same time contribute considerable weight to propagation mixes
- d) If used in too high a proportion, can create a poorly aerated and poorly draining growing environment
- e) Can be the source of weed seeds and pathogens if not from a well-managed, high quality site, and can lead to the spread of weed and pathogens as soils are moved from field to greenhouse to new fields

3. Coarse sand

- a) Provides excellent drainage and aeration for soil mixes
- b) Provides valuable bulk density but at the same time contributes considerable weight to propagation mixes and is not suitable for use in polystyrene (Speedling type) containers because sand readily scars the containers, creating sites that roots will cling to or that can harbor pathogens
- c) Although not a renewable resource, it is abundant around the world and thus does not create long- distance transportation impacts

4. Perlite

Of volcanic origin, perlite is a mined mineral, ground, graded, and heated in kilns to 1600°F, which causes microscopic quantities of water in the ore to turn into a gas. This in turn causes the raw perlite to expand, popcorn style, to 4–20 times its original size.

- a) An excellent source of drainage and aeration in soil mixes, while also being very light weight and easy to handle
- b) Can retain 2–3 times its weight in water
- c) Is sterile when first removed from its packaging and is therefore not a source of weed seeds or pathogens, and normally has a pH of 7.0
- d) Greece, the United States, especially NM, UT and OR, along with China are the biggest producers of perlite
- e) Production is very energy intensive, from mining, to expansion of the raw ore, to transport from remote locations to market
- f) Alternatives to perlite include sand, pumice, rice hulls, processed corncob waste, and composted grape seed

5. Vermiculite

A micaceous mineral, vermiculite is mined and then processed in kilns heated to 1000°F. While in the kilns, microscopic water molecules trapped in the ore are vaporized, which in turn causes the ore to exfoliate, accordion style, into a material that has a huge surface to volume ratio.

- a) Outstanding ability to hold water, at least four times its own weight
- b) High cation exchange capacity (CEC) and especially effective at holding on to K, Mg, Ca, and P
- c) By virtue of its size and shape, provides good drainage and aeration, while also being lightweight and easy to handle
- d) Is sterile when first removed from its packaging and is therefore not a source of weed seeds or pathogens, and has a pH of 7.0
- e) Produced domestically in South Carolina and Virginia, imported from South Africa, Brazil, China, and several other sources
- f) Alternatives to vermiculite include partially composted cotton gin waste, ground pine and fir bark, sand, and leaf mold

6. Peat moss

Derived from wetland bogs in many countries in the far North, consists of the remains of partially decomposed sphagnum moss, and allied plants, held in a state of very slow decomposition because of the water-saturated, anaerobic environment in the depths of the bogs

- a) An outstanding source for water retention, holding 4–6 times its weight in water, while at the same time providing for good drainage and aeration
- b) Brings high CEC potential to mixes, and has a pH of approximately 4.5
- c) There is debate as to the sustainability of peat mining practices. Also, peat bogs are the world's largest carbon repositories and trap more CO₂ than even tropical rainforests. The disruption caused by extraction releases huge quantities of CO₂ into the atmosphere, adding to greenhouse gases even after sites are restored.
- d) Alternatives to peat moss include coco peat, partially composted wood waste, mushroom compost, locally harvested leaf mold, and perhaps in the future, dairy waste fiber sourced from anaerobic digesters

7. Coco Peat/Coir Fiber

A byproduct of the coconut industry, coconut husks/fibers were once disposed of, but now have become a significant input in the horticulture industry, often used in place of peat moss in nursery and greenhouse operations

- a) Has outstanding ability to retain water, roughly six times its own weight, while at the same time providing for good drainage and aeration
- b) Has good CEC capacity and is a small source of NPK at .5-.03-.25 and an average pH of 6.5
- c) If not properly leached before packaging and shipment, can contain excess salts, which are detrimental to most developing seedlings and subsequent growth; leaching of salts consumes significant quantities of fresh water
- d) Sourced in the United States principally from the Philippines, India, Sri Lanka, and Madagascar, this ingredient has a carbon footprint needing further investigation given its long distance transport to market
- e) Alternatives to coco peat include locally harvested leaf mold, partially decomposed wood wastes, mushroom compost, and perhaps in the future, dairy waste fiber sourced from anaerobic digesters

8. Beneficial fungal inoculation

Products such as Rootshield can provide growers with a buffer against fungal pathogens in soil media

- a) Trichoderma fungi, when introduced into soil media, can occupy the physical niche that might otherwise be occupied by pathogenic fungi that can harm seeds and seedlings
- b) Trichoderma fungi can also act as direct antagonists to pathogenic fungi, functioning on your behalf to keep crops healthy
- c) Like other living organisms, fungal inoculants should be protected against degradation and stored refrigerated to extend their shelf life
- d) While human health concerns are limited, basic safety precautions like wearing gloves, long sleeves, a dust mask and eye protection are all recommended when handling beneficial fungi, as with all other dry, powdered ingredients

C. Environmental Impacts and Sustainability in Soil Mixes and Media

1. As noted above, many of the most commonly used ingredients in soil mixes come either from non-renewable or questionably sustainable sources. Selecting soil mixes for container grown plants is one of the decisions where organic growers often make choices that may not be fully in alignment with their philosophical principles.
 - a) Sustainably oriented growers should seek out non-toxic, naturally occurring, non-extractive, and renewable resources and byproducts of other processes as a starting point when trying to build soil mix recipes. When less sustainable choices are made, it is important to use these costly resources wisely in an effort to maximize their efficacy and reduce your overall environmental impacts.
 - b) Live, biologically active mixes are principally reliant on diverse soil organisms, in the presence of water, for pest and disease suppression, for the decomposition of undigested organic matter in mixes, and for the release of nutrients from the plant and mineral derived components of the growing media
 - c) The grower can control the structure and texture of soil mixes, which dictate drainage, aeration, and moisture retention, when creating or selecting soil media
 - d) The structure and texture of your growing media, combined with your cultural practices—frequency of water delivery, temperature regulation, and the management of air circulation—should work synergistically to foster healthy, steady, and uninterrupted growth of seedlings as they move toward transplant maturity
2. Storage and handling of soil ingredients and mixes

To maintain the integrity and quality of ingredients and mixes, growers need to take some basic precautions

- a) Protect ingredients from degradation by sun, wind, rain, and extreme temperatures
- b) Store ingredients in a cool, well-aerated, rain-free location, away from potential sources of pathogens and weed seeds infestation. Protecting against these possibilities will go a long way toward improving crop health, minimizing losses, and reducing labor inputs.
- c) Blend mix media in small batches for near-term use:
 - i. Small batch production is particularly important to maximize the benefits of live, biologically active ingredients such as the bacteria and fungi present in composts, and purchased inoculants, e.g., Trichoderma fungi
 - ii. Long-term storage of large volumes of mix can lead to compaction, loss of structural properties, and diminished nutrient supply due to volatilization or leaching
 - iii. If allowed to dry, large volumes of soil can be much more difficult to evenly re-wet for use in mixes

D. Supplemental Fertility in the Greenhouse

1. Conditions where supplemental fertility may be necessary or useful

Although organic mixes ideally contain all the fertility needed to sustain steady, uninterrupted plant growth, there may be times where additional inputs are necessary

- a) To compensate for poor quality, nutrient-deficient ingredients, especially immature or older, poorly stored compost
- b) To promote biological activity and nutrient release by supplying nitrogen to the soil microbial population; microbes use supplemental nitrogen to facilitate the release of plant-based nutrients from the soil mix
- c) To alleviate stress, especially in cell-type containers when plants are past optimal transplant stage, have become root bound, or are showing signs that previously available nutrients have been exhausted
- d) To stimulate growth, such as when the grower needs to accelerate plant growth for a specific plant-out date or when seedlings have been contracted for sale and it is clear that they will not reach salable size quickly enough

2. Potential concerns when using supplemental fertility

- a) Water soluble nutrients such as the nitrogen in fish emulsion can easily be leached out of growing containers and potentially enter local waterways if irrigation is poorly managed and vegetative buffer strips are not present to preserve water quality (see Supplement 2, Conserving Water and Protecting Water Quality)
- b) Inputs can be expensive, and need to be available on site so that fertility issues can be quickly addressed
- c) Supplemental fertility typically requires substantial additional labor for application
- d) Additional application equipment is required; in some cases, additional filtration is needed if being applied through drip or fine-nozzled spray systems
- e) Excess nitrogen application can promote highly nitrogenous, pest-susceptible growth, which may then lead to using more inputs to control pests
- f) Overreliance on highly soluble nutrient inputs mimics the conventional mindset of feeding plants directly, with readily available ingredients, rather than building soil health and biology to promote nutrient release and pathogen resistance

3. Ways to apply supplemental fertility

- a) Inputs can be blended into soil mixes at time of mix making. This common strategy requires advance knowledge of need for additional fertility and is most useful with medium- to slower-acting meals and powdered ingredients.
- b) Powdered, granular, and pelletized ingredients can be “top dressed” on the surface of container soils. This can be effective with fast- to medium-acting inputs, depending on the crop life cycle and extent of immediate need.
- c) Water soluble inputs are commonly applied as a soil drench as part of a regular irrigation set, thus becoming a “fertigation.” This is a particularly useful, quick-fix approach to address immediate nutrient deficiencies or to rapidly increase the rate of plant growth using readily available, water-soluble nutrients, delivered with irrigation directly to the root zone.
- d) Water-soluble nutrients can also be delivered as foliar sprays, specifically directed at the leaf undersides where stomata are concentrated to maximize uptake potential

4. Commonly used supplemental fertilizers for soil drenches and foliar application (see Resources section for sources of OMRI-/NOP-certified supplemental fertilizers)

- a) Fish emulsions and soluble fish powders for N-P-K (2-5N-2-4P-0-2K) are regularly used for both soil and foliar applications. They provide immediately available nutrients to support growth.

- b) Kelp extracts and powders supply micronutrients, naturally occurring growth hormones, a minor amount of N and up to 4%K, all in a form readily accessible to crops. Care should be taken using kelp meal extracts in seedling mediums, as too much can stunt plant growth.
- c) Worm castings tea (dilute N-P-K and disease suppression)
- d) Compost teas, brewed on farm from high quality composts can provide a dilute source of N-P-K and micronutrients. By inoculating soil and foliage with beneficial bacteria and fungi, they can also suppress diseases.
- e) As the market for inputs has expanded, a wide array of soluble products has become available. Growers should consult with others in their area to see what products have been most valuable and provide the greatest return on investment.

E. Container Formats for Seedling Production (see Appendix 6, Examples of Propagation Containers)

1. Cell/plug type trays: The most common containers for contemporary seedling production. They are manufactured in a huge array of cell sizes and cell shapes. The key is to match cell size with root nature of the crop, size of desired transplant, appropriate media, and available space in the greenhouse. These containers are normally made out of expanded polystyrene, high density polypropylene, or polyethylene. Each has advantages and disadvantages.
 - a) Advantages of cell/plug trays
 - i. The close spacing of cells allows growers to maximize plant density in valuable greenhouse space
 - ii. Because cell size are relatively small when compared to traditional wooden flat-grown crops, growers use very little soil media to produce thousands of plants
 - iii. Because each plant grows individually, in a separate cell, roots do not intertwine and thus do not have to be separated at time of transplanting
 - iv. Roots are “air pruned” when they reach the bottom of the cell, in most plug tray designs, which causes roots to branch higher up and more rapidly fill out the root ball
 - v. Because plants with well “knitted” roots that hold the soil ball together can be easily removed from the plug trays, it is possible to plant most crops with little to no transplant shock, assuming the grower otherwise uses good transplanting practices
 - b) Disadvantages of cell/plug trays
 - i. The small volume of soil used cells/plugs means that each individual plant has limited access to soil nutrients, thus increasing the likelihood growers will have to use supplemental fertility to keep plants growing strong or to hold them if transplanting time is delayed
 - ii. Small cells have limited root runs, which shortens the window of opportunity for optimal transplant timing, again leading to the potential need for supplemental fertility
 - iii. The small volume of soil means that growers will have to water more frequently to compensate for the rapid soil drying that is likely when temperatures are hot and plug sizes are small
 - iv. Some flat bottom cell designs drain poorly and actually hold water at the bottom of the cell. This “perched water table” can be problematic for crop roots sensitive to rotting or those needing abundant oxygen throughout the root zone.
 - v. Some round cell designs can promote “root spiraling,” causing plants to become root bound early in their development

- vi. Cell/plug trays are currently all manufactured from non-renewable sources and even when recyclable, their manufacture, recycling and eventual disposal have high life environmental footprints (see Appendix 8, Environmental Impacts of Cell/Plug Trays)
2. Traditional wooden flats, though seldom used in contemporary greenhouse and on-farm production systems, have many valuable characteristics as well as several inherent disadvantages
- a) Advantages of wooden flats for propagation
 - i. By growing plants at a relatively low density, this format provides a very large root run. This expanded resource base can grow large, vigorous starts resistant to pest and disease pressure and tolerant of weather variables.
 - ii. Substantial nutrient supply per plant means that plants have plenty of nutrients to grow steadily and without interruption
 - iii. Substantial soil volume per plant also means growers will have to deliver water less frequently.
 - iv. The large soil volume and nutrient supply gives growers a long window of opportunity to transplant while crops are still in their prime, even if soil or weather conditions delay planting beyond what would normally be acceptable for cell/plug-grown crops
 - b) Disadvantages
 - i. This format consumes large volumes of soil media, thus increasing production costs for both labor and materials
 - ii. Lower plant density afforded by typical spacing in wooden flats means that precious greenhouse space may not be being used to optimum capacity
 - iii. Flats filled with well-watered mix, especially mixes that use substantial quantities of compost, sand, or soil can be very heavy, requiring more labor, and increasing the risk of lower back injuries
 - iv. Because roots all grow together in the open flats, this format has much greater potential for root disturbance and transplant shock even with the most delicate handling, when individual plants and roots are separated from the inevitable intertwined root mass.

Demonstration 1: Greenhouse Management

for the instructor

OVERVIEW

This demonstration provides students with an understanding of the working components of the greenhouse facility and the tools available to manage environmental conditions that best meet the needs of pre-emergent and seedling crops in the facility. Students should become familiar with the fundamental skills and concepts to create ideal growing conditions, such as temperature and air circulation management.

PREPARATION AND MATERIALS

- A working greenhouse structure where the essential management tools and techniques can be discussed and demonstrated
- Thermometer and Appendix 12, Greenhouse Records Sheet, to show current conditions and records of recent temperature fluctuations
- Thermometers positioned in different microclimatic zones (if applicable) to show how differences can be used to meet different plant needs under a single management regimen

PREPARATION TIME

1 hour

DEMONSTRATION TIME

1 hour

DEMONSTRATION OUTLINE

A. Managing Greenhouses

1. Discuss and demonstrate orientation of greenhouse (i.e., solar aspect)
2. Discuss and demonstrate methods for air circulation via venting, fans, etc.
3. Discuss and demonstrate temperature management
 - a) Ideal temperature ranges (see Appendix 3)
 - b) How heat is retained
 - c) The use of thermal mass in heat retention
 - d) Techniques for evaporative cooling
 - e) The role of venting in maintaining ideal temperature, humidity, and gas exchange
 - f) Active heating systems
4. Use of microclimates within greenhouse
5. Discuss and demonstrate record keeping in the greenhouse (see Appendix 12)
 - a) Date
 - b) Previous high/low
 - c) Current temperature
 - d) Weather description
 - e) Description of environmental conditions in greenhouse
 - f) Management actions taken

Demonstration 2: Propagation Media

for the instructor

OVERVIEW

Students will examine both unblended propagation ingredients and the completed propagation media. By looking at the individual ingredients, finished propagation media, and typical garden soils in containers, students will see the components of propagation media that are critical to creating proper drainage, aeration, and moisture retention. The instructor should also emphasize the importance of proper moisture in propagation media so that root-to-soil and/or seed-to-soil contact can be achieved with only minimal additional water inputs. Instructors should be certain to discuss the importance of proper storage and handling of media to maintain fertility and protect against contamination by pathogens.

PREPARATION AND MATERIALS

1. Have both wet and dry samples of several possible raw ingredients that are used in propagation media: Compost, soil, sand, perlite, vermiculite, composted wood chips, grape seed pumice, peat moss, and coir fiber, etc.
2. Have wet and dry samples of the media commonly used in your operation and perhaps others such as the Cornell Peat Lite Mix and the UC Potting Mix (see Resources section) and/or commercial propagation media for comparison
3. Assemble necessary tools (flat head shovels, wheelbarrows) and hoses to supply moisture
4. Assemble ingredients to make the desired mix of ingredients

PREPARATION TIME

1.5 hours

DEMONSTRATION TIME

1.5 hours

DEMONSTRATION OUTLINE

A. Propagation Media

1. Review desirable characteristics of propagation media
2. Review individual media constituents and properties imparted by each
 - a) Show ingredients that provide nutrients (N, P, K, and micronutrients)
 - b) Show ingredients that promote drainage and aeration
 - c) Show ingredients that serve to retain moisture
3. Demonstrate the techniques of blending materials to create homogenized media
4. Assess and adjust media for appropriate moisture
5. Discuss use and proper storage techniques for propagation media

Demonstration 3: Sowing Seed

for the instructor

OVERVIEW

In this demonstration students should observe and participate in sowing a variety of different seed types and sizes in both cell trays and wooden flats. Students will review the advantages and disadvantages of each format and why certain crops may be better suited to a particular method. In this session, a discussion and look at various seed sizes will illustrate the importance of sowing seeds to appropriate depths to ensure a high percentage of germination and seedling survival.

PREPARATION AND MATERIALS

1. Assemble a selection of different cell/plug trays
2. Assemble wooden flats suitable for seed sowing
3. Bring both large (sunflowers, squash, etc.) and small seeds (lettuce, larkspur, snapdragon, etc.) to illustrate the range of seed sizes
4. Bring any mechanical seeding devices such as sliding plate seeders and seeds appropriate to their use

PREPARATION TIME

1 hour

DEMONSTRATION TIME

1 hour

DEMONSTRATION OUTLINE

A. Seed Sowing Techniques

1. Demonstrate container-filling techniques
2. Discuss the advantages and disadvantages of each container format
3. Demonstrate sowing and coverage techniques
 - a) Discuss and demonstrate techniques for broadcasting and drilling seed into flats, including proper depth
 - b) Discuss the significance of seed density as it relates to potential future competition and timing of pricking out
 - c) Discuss and demonstrate sowing by hand into cell type trays
 - d) Discuss and demonstrate sowing into cell trays with a sliding plate seeder or other mechanisms
4. Discuss labeling and record keeping and their importance in maintaining variety distinctions, trouble shooting, and future crop planning (see Appendix 11)
5. Discuss and demonstrate watering-in techniques
6. Discuss and demonstrate optimal min/max germination temperatures (see Appendix 3)
7. Discuss days to germination at varying temperatures (see Appendix 4)
8. Discuss and demonstrate optimal post-germination growing temperatures for seedlings (see Appendix 5)

Demonstration 4: Transplanting or “Pricking Out” *for the instructor*

OVERVIEW

This demonstration illustrates the technique of transplanting immature seedlings from a high-density flat format to a lower-density format. The importance of doing this work under appropriate environmental conditions (low light levels, low temperatures, high relative humidity, and still air/low wind velocity) cannot be overemphasized. Students will have the chance to look at plant development and its relevance to successful transplanting or “pricking out” in the greenhouse setting. Be sure to emphasize the significance of seedling density and proper timing of pricking out to prevent undue competition for resources and to prevent diseases.

PREPARATION AND MATERIALS

1. Have plants available for visual inspection that only show taproot development
2. Gather plants that have initiated a branched root system suitable for pricking out
3. Have plants showing signs of overdevelopment that would make pricking out more difficult
4. Have undersown (very low-density) flats to illustrate inefficient use of space as well as the wider window of opportunity possible when young plants are not competing for resources
5. Have oversown flats illustrating the effects of competition and the imperative of moving swiftly to prevent disease and alleviate the effects of nutrient stress
6. Have flats sown at appropriate density to demonstrate best use of space and proper timing for movement.
7. Have plants of basal rosette nature (e.g., statice, *Limonium sinuatum*) and upright nature (e.g., snapdragons, *Antirrhinum majus*) to discuss and demonstrate appropriate planting depth relative to seedling architecture and physiological adaptations such as adventitious rooting

PREPARATION TIME

1 hour

DEMONSTRATION TIME

1.5 hours

DEMONSTRATION OUTLINE

A. Transplanting and Pricking Out Techniques (see Appendix 9)

1. Review/discuss environmental conditions appropriate to plant handling
2. Discuss and demonstrate stages of plant development appropriate for pricking out
3. Discuss and demonstrate plant root systems appropriate for pricking out
4. Discuss and demonstrate the significance of seedling density relative to timing of pricking out
5. Discuss and demonstrate proper/gentle handling techniques when dealing with young/easily injured seedlings
6. Discuss and demonstrate techniques for watering-in transplants
7. Discuss labeling and record keeping and their importance in maintaining variety distinction, trouble shooting, and future crop planning (see Appendix 11)
8. Discuss considerations for post-transplant care

Demonstration 5: Greenhouse Irrigation

for the instructor

OVERVIEW

In this demonstration, students will learn about the various tools and techniques used to deliver water to pre-emergent seeds and seedlings in a given propagation facility. Emphasis should be placed on creating optimal soil moisture conditions to facilitate healthy plant growth through proper irrigation frequencies and volumes of water applied. You should also discuss the advantages and disadvantages of the systems and tools used.

PREPARATION AND MATERIALS

- All irrigation equipment commonly used in the propagation facility (e.g., hoses, watering cans, fixed spray nozzles, irrigation timers and solenoid control valves, mist systems, etc.)
- Recently sown seeds in flat and cell tray format
- Seedlings in flat and cell tray format

PREPARATION TIME

1 hour

DEMONSTRATION TIME

1 hour

DEMONSTRATION OUTLINE

A. Irrigating Seeds and Seedlings

1. Discuss and demonstrate irrigation techniques prior to seedling emergence with attention to the differences in wet-to-dry swing for large- and small-seeded crops
2. Discuss and demonstrate irrigation techniques used for post-seedling emergence and early seedling development
3. Discuss the typical changes in frequency and volume of water delivered during seedling development (i.e., from pre-germination—frequent, shallow applications—to lower frequency, greater volume of water supplied as seedlings mature)
4. Discuss and demonstrate any necessary adjustments needed based on germination, disease or pest problems, and/or plant growth observations
5. Emphasize the importance of paying extra attention to corners and edges of greenhouse; these are often overlooked

Demonstration 6: Seedling Development & the “Hardening Off” Process

for the instructor

OVERVIEW

This demonstration shows students how to prepare seedlings for field transplanting.

PREPARATION AND MATERIALS

- Seedlings at varying stages of maturity

PREPARATION TIME

0.5 hour

DEMONSTRATION TIME

0.5 hour

DEMONSTRATION OUTLINE

A. The Hardening Off Process

1. Define the hardening off process and its role in seedling maturation and survival
2. Discuss characteristics of seedling maturity (see Appendix 10)
3. Discuss regional importance and influence on duration of hardening off process. Greater temperature differences between greenhouse and field conditions will require a longer hardening off period.
4. Discuss and demonstrate the various propagation structures and techniques used in the hardening-off progression
 - a) Highly controlled environment of greenhouse settings
 - b) Partially moderated conditions: Hoophouses
 - c) Outdoor benches approximating field conditions
5. Provide examples of seedlings prepared for transplanting

Assessment Questions

- 1) List two pre-conditions that must be met for seed germination and four environmental conditions that must be achieved for optimal seed germination.
- 2) What is the optimal average daytime temperature *range* that should be maintained in the greenhouse for the germination and early growth of most annual vegetables and cut flowers? What would be the minimum nighttime temperature?
- 3) List four advantages of the use of greenhouse-raised transplants over direct seeding of crop plants. Describe two disadvantages.
- 4) Why is the careful selection of crop *varieties* important?
- 5) What are four important qualities of a propagation mix? List two propagation mix constituents that may be used to assure each of the previously listed qualities.

- 6) What pieces of information are commonly documented in the propagation process and why?
- 7) What is the “hardening off” process?
- 8) List two characteristics of cell-tray-grown seedlings at transplanting maturity.
- 9) List two necessary steps for preparing seedlings before transplanting them to the field or garden.
- 10) List the environmental conditions most favorable for successful bare-root transplanting/ pricking out seedlings grown in a flat format.
- 11) Describe four preventive measures and two active measures used to control fungal plant pathogens in greenhouse facilities.

Assessment Questions Key

- 1) List two pre-conditions that must be met for seed germination and four environmental conditions that must be achieved for optimal seed germination.

Pre-conditions:

- *Viable seed*
- *Dormancy factor released*

Necessary environmental conditions for seed germination and role of each:

- *Optimal temperature range: To increase the rate of respiration*
- *Optimal moisture range: To soften seed coat and increase the rate of respiration*
- *Aeration: To provide adequate air circulation for supplying oxygen used in respiration and remove carbon dioxide produced during respiration*
- *Light: Though not needed for germination of all seeds, light stimulates increased respiration in some plants*

- 2) What is the optimal average daytime temperature *range* that should be maintained in the greenhouse for the germination and early growth of most annual vegetables and cut flowers? What would be the minimum nighttime temperature?

- *Optimal average temperature range is between 65–85°F. (The average optimal germination temperature for most vegetables and cut flowers is 82°F. Please see appendix 2 for specific minimum, maximum, and optimal germination temperatures.)*
- *Minimum nighttime temperature should not dip below 55°F*

- 3) List four advantages of the use of greenhouse-raised transplants over direct seeding of crop plants. Describe two disadvantages.

Advantages of transplants:

- *Season extension*
- *Ability to manage environmental conditions: Temperature, moisture, air circulation and growing media*

- *Crop selection*
- *Ability to intensively manage large numbers of plants in a small area*
- *Efficient use of seed, water and space*

Disadvantages of transplants:

- *Additional infrastructure costs*
- *Additional skill and labor required*
- *Not all crops grow or transplant well from containers*
- *Additional non-renewable resource use*
- *Often results in more total days of growth*

- 4) Why is the careful selection of crop varieties important?

- *To help assure disease resistance*
- *To help assure good crop performance in different climates or micro-climates*
- *To help assure other crop qualities such as storage, visual aesthetics, flavor, etc.*

- 5) What are four important qualities of a propagation mix? List two propagation mix constituents that may be used to assure each of the previously listed qualities.

- *Drainage. Constituents that impart this quality: Perlite, sand, soil, leaf mould, gravels and lava rock, and to a lesser extent, vermiculite, compost, peat moss, and coir fiber*
- *Aeration. Constituents that impart this quality: Perlite, sand, soil, leaf mould, gravels and lava rock, and to a lesser extent, vermiculite compost, peat moss and coir fiber*
- *Density. Constituents that impart this quality: Sand, soil, gravel, compost, and leaf mould*
- *Nutrient availability. Constituents that impart this quality: Compost, soil, mineral and organic matter amendments, and leaf mould*
- *Water-holding capacity. Constituents that impart this quality: Compost, peat moss and coir fiber, vermiculite*

6) What pieces of information are commonly documented in the propagation process and why?

- *Genus and species of crop*
- *Variety of crop*
- *Date sown*
- *Date pricked out (if applicable)*
- *Seed company name*
- *Seed lot (year seed was produced for)*

Why: The above would provide adequate information for future trouble shooting and the selection of crops during variety trials

7) What is the "hardening off" process?

The gradual exposure and acclimation of greenhouse-raised transplants to the environmental conditions of the field.

8) List two characteristics of cell-tray-grown seedlings at transplanting maturity.

- *Second set of true leaves initiated*
- *Root knit*

9) List two necessary steps for preparing seedlings before transplanting them to the field or garden.

- *Pre-moistened to 75% field capacity*
- *Hardened-off for 3–21 days*

10) List the environmental conditions most favorable for the successful bare-root transplanting/ pricking out seedlings grown in a flat format.

- *Low light levels*
- *Low temperatures*
- *Low wind velocity*

11) Describe four preventive measures and two active measures used to control fungal plant pathogens in greenhouse facilities.

Preventive measures:

- *Proper sanitation of propagation media, facilities, and containers*
- *The selection and use of disease-resistant varieties*
- *The selection and use of climate-appropriate varieties*

- *The use of disease-free seed stock*
- *Management of environmental conditions of greenhouse (air circulation, temperature, light) and propagation media (moisture, aeration, nutrients) within the optimal range. Good cultural practices.*

Monitoring

Active measures:

- *Roguing affected crops*
- *Biological control*
- *The use of acceptable chemical controls*

Resources

PRINT RESOURCES

*Books that are particularly useful, best places to spend your money.

*Beytes, Chris (ed.). 2011. *Ball RedBook, Volume 1: Greenhouses and Equipment, 18th Edition*. Greensboro Books.

Covers all aspects of greenhouse equipment—the structures themselves, benches, irrigation, curtains, environmental controls, machination, and the greenhouse as a retail facility. The most recent developments in greenhouse evolution are discussed, as are the varieties of available greenhouse structures, from freestanding and gutter-connected greenhouses to shade houses and open-roof greenhouses. Includes information on how to market products and how to operate a retail store from a greenhouse.

Cranshaw, Whitney. 2004. *Garden Insects of North America: The Ultimate Guide to Backyard Bugs*. Princeton, NJ: Princeton University Press.

A comprehensive, user-friendly guide to the common insects and mites affecting yard and garden plants. Uses full-color photos and concise, clear, scientifically accurate text, to describe the vast majority of species associated with shade trees and shrubs, turfgrass, flowers and ornamental plants, vegetables, and fruits. For particularly abundant bugs adept at damaging garden plants, management tips are also included. Provides basic information on host plants, characteristic damage caused to plants, distribution, life history, habits, and, where necessary, how to keep “pests” in check.

Deno, Norman. 1994. *Seed Germination Theory and Practice, 2nd Printing*. Self published, State College, PA. naldc.nal.usda.gov/download/41278/PDF

Important reference on principles of seed germination and the use of specific techniques for a wide array of cultivated crops.

Dirr, Michael A., and Charles W. Heuser, Jr. 2006. *The Reference Manual of Woody Plant Propagation: Seed to Tissue Culture, 2nd Edition*. Cary, NC: Varsity Press, Inc.

Over 1,100 species and their propagation

requirements by seeds, cuttings, grafting and budding, and tissue culture are discussed in detail.

*Dreistadt, Steve, and Mary Louise Flint. 2001. *Integrated Pest Management for Floriculture and Nurseries*. Publication 3402. Oakland, CA: University of California Division of Agriculture and Natural Resources.

Outstanding resource for developing a pest management program.

Flint, Mary Louise. 1998. *Pests of the Garden and Small Farm and Garden: A Grower's Guide to Using Less Pesticide, Second Edition*. Publication 3332. Oakland, CA: University of California Division of Agriculture and Natural Resources.

Excellent tool for the identification of common greenhouse pests and pathogens.

Flint, Mary Louise, and Steve Dreistadt. 1998. *Natural Enemies Handbook: The Illustrated Guide to Biological Pest Control*. Publication 3386. Oakland, CA: University of California Division of Agriculture and Natural Resources.

A valuable resource for biological control of pests and pathogens.

Greer, Lane. 2005. *Plug and Transplant Production for Organic Systems*. ATTRA, National Center for Alternative Technology (NCAT). www.attra.ncat.org/attra-pub/PDF/plugs.pdf.

Describes the process of producing transplants using methods that conform to National Organic Program (NOP) regulations. Includes information on containers, media, equipment, nutrition, irrigation, pest management, and more.

Hanan, Joe. 1998. *Greenhouses: Advanced Technology for Protected Horticulture*. Boston, MA: CRC Press.

Exhaustive reference on all aspects of greenhouse design and management, written principally from a conventional perspective, but with much valuable information for the organic grower.

Hartmann, Hudson, Dale Kester, Fred Davies, Jr., and Robert Geneve. 2010. *Plant Propagation: Principles and Practices, 8th Edition*. Upper Saddle River, NJ: Prentice Hall.

The standard reference tool for propagators, covering all aspects of sexual and asexual propagation, principally from a large-scale, conventional focus.

Johnston, Robert Jr. 1983. *Growing Garden Seeds: A Manual for Gardeners and Small Farmers*. Albion, ME: Johnny's Selected Seeds.

Brief but valuable reference on seed viability and seed production strategies.

Jozwik, Francis X. 2000. *The Greenhouse and Nursery Handbook: A Complete Guide to Growing and Selling Ornamental Container Plants*. Mills, WY: Andmar.

Good general information for small- to medium-scale growers.

Maynard, Donald N., George J. Hochmuth, and James Edward Knott. 2007. *Knott's Handbook for Vegetable Growers, 5th edition*. Hoboken, NJ: John Wiley & Sons, Inc.

The standard reference for field-scale vegetable production, but also provides many valuable charts on seed viability, germination temperatures, days to germination, etc.

Milne, Lorus Johnson, and Margery Milne. 1980. *National Audubon Society Field Guide to North American Insects and Spiders*. New York: Alfred A. Knopf.

Great visual reference for identifying both beneficial and pest species.

Olkowski, William, Sheila Daar, and Helga Olkowsk. 1991. *Common Sense Pest Control*. Newtown CT: Taunton Press.

Excellent reference for non-toxic pest control strategies geared both for homeowners and production-oriented growers.

Rubatzky, Vincent E., and Mas Yamaguchi. 1999. *World Vegetables: Principles, Production, and Nutritive Values, 2nd edition*. Gaithersburg, MD: Aspen.

Invaluable resource on the history and origins of major world vegetable crops and their cultural requirements.

*Styer, Roger, and David Koranski. 1997. *Plug and Transplant Production*. Batavia, IL: Ball Publishing.

Excellent discussion on soils and containers and detailed information on managing environmental conditions for vegetable and cut flower transplants.

Thompson, Peter. 2005. *Creative Propagation, 2nd edition*. Portland: Timber Press.

Very user-friendly guide to growing plants from seed, cuttings, and divisions.

Walls, Ian. 1996. *The Complete Book of the Greenhouse*. London: Ward Lock.

Geared toward small-scale and backyard growers, this book provides good information on greenhouse design and management tools.

WEB-BASED RESOURCES

Appropriate Technology Transfer for Rural Areas

www.attra.org

ATTRA provides excellent information on numerous topics. For Propagation, see especially titles from the Greenhouse Production of the Master List of Publications for topics such as soil mixes for containers, plug and transplant production, amendments, supplemental fertilizers, compost tea and much more.

Biology Resources DG Mackean

www.biology-resources.com

An excellent website with links to illustrations of bean, pea, sunflower, and wheat seed structure and germination; time lapse videos of mung beans, corn and peas germinating; digestible Powerpoint presentations on photosynthesis, cell division, and respiration.

Cornell Resource Guide for Organic Insect and Disease Management

web.pppmb.cals.cornell.edu/resourceguide/

Thorough guide to pest and disease identification in vegetable crops, primarily for in-the-ground issues, but can be applied to seedlings as well. Useful content on organic materials/inputs for pest and disease control, most of which have direct application in the greenhouse.

eXtension, Organic Potting Mixes

www.extension.org/pages/20982/organic-potting-mix-basics#.VN0ZB7DF_v6

Covers basic information about organic potting mixes for organic farming systems.

Integrated Pest Management, UC Davis

www.ipm.ucdavis.edu

Excellent resource for insect identification and non-chemical control strategies, as well as links to other sites concerned with pests and pathogens. While focused on California, the content is highly transferable to growers in other regions.

New York State/Cornell IPM Program

www.nysipm.cornell.edu

Valuable resource covering many fruit and vegetable crops, including identification information, cultural practices and inputs to manage pests and diseases.

Royal Horticultural Society

www.rhs.org.uk/Advice/Profile?PID=710

Provides clear definition of F1 Hybrids and explanation of how F1 Hybrids are produced, as contrasted with open pollinated seed varieties.

www.rhs.org.uk/advice/profile?PID=501

Provides straightforward explanation of methods and conditions for growing seedlings indoors.

Soil Foodweb

www.soilfoodweb.com

A clearinghouse for information and research summaries on soil ecosystem process and a product, services and resource for how to grow crop plants without the use of pesticides or inorganic fertilizers. Includes how-to manuals on the production of compost teas.

University of Massachusetts Extension Greenhouse Crops and Floriculture Program

extension.umass.edu/floriculture/fact-sheets/greenhouse-management-engineering

Links to many valuable website pages for organic and conventional greenhouse producers on design, energy efficiency, water management, environmental management, pest and disease monitoring, and more.

extension.umass.edu/floriculture/fact-sheets/organic-greenhouse-production-and-resources

Provides information and links to a wide array of topics germane to organic growers, including biocontrol, growing media and fertility inputs.

extension.umass.edu/floriculture/greenhouse-best-management-practices-bmp-manual

Provides link to lengthy publication on Best Management Practices for greenhouses. Focus is on conventional production, but contains lots of information relevant to organic production.

SEED COMPANIES

The following sources offer exclusively GMO-free varieties, specify if their seed is fungicide treated, and can supply letters for your Certifier stating that your purchases are in compliance with the USDA's National Organic Program (NOP) regulations.

Baker Creek Heirloom Seeds

www.rareseeds.com

Large collection of heirloom and difficult-to-find vegetable seeds.

Botanical Interests

botanicalinterests.com

Purveyor of vegetable, flower, and herb seeds, many organic and heirloom varieties.

Bountiful Gardens

www.bountifulgardens.org

Vegetable and small grain seeds, seeds for compost biomass production, principally open-pollinated varieties, nutritionally dense crops.

Fedco

www.fedcoseeds.com

Vegetable, flower, and herb seeds, tubers and allium bulbs, many organic and open pollinated varieties.

Fred C. Gloeckner Co.

www.fredgloeckner.com

Flower seeds, bulbs, plug broker, and grower supplies.

Geo Seed

www.geoseed.com

Flower, ornamental grass, and perennial seeds for cut flower growers.

Germania Seed

www.germaniaseed.com

Flower seeds, select vegetables, plug broker representing many annual and perennial plug producers.

Gourmet Seed International

www.gourmetseed.com

Focusing on vegetable and herb seeds of unusual varieties, many heirlooms.

Harris Seeds

www.harrisseed.com

Vegetable and flower seeds, good line of organic varieties, plug broker, catering to both home gardeners and professional growers.

Hearne Seeds

hearneseed.com

Full line of cover crop seeds, both conventional and organic.

High Mowing Seed Co.

www.highmowingseeds.com

Offers over 600 varieties of heirloom, open pollinated, and hybrid seeds, 100% organic collection of vegetable, herb, and some flower seed.

Horizon Herbs

www.horizonherbs.com

Extensive collection of medicinal and culinary herbs and other useful plants from around the world.

Ivy Garth Seed Co.

www.ivygarth.com

Flower and vegetable seed featuring the latest varieties, and a broker for many plug growers.

J. L. Hudson Seedsman

www.jlhudsonseeds.net

A “public access seed bank,” focused on the preservation of botanical diversity and the distribution of rare plants from every continent; species span the scope of ethnobotanical interests.

Johnny’s Selected Seeds

www.johnnyseeds.com

Vegetable, herb, and flower seed, production supplies, numerous organic varieties and a range of seed pack-out sizing.

Kitazawa Seed Co.

www.kitazawaseed.com

Packet and bulk vendor of vegetable seeds, featuring many Asian varieties not readily available from other sources.

Modena Seed Co.

www.modenaseed.com

Extensive cut flower seed selection, great pricing and volume sizing.

Native Seed SEARCH

www.nativeseeds.org

Vegetable and non-cereal grain seeds, land race peppers, with core mission to preserve and distribute the traditional crops of the native peoples of the Southwestern U.S.

Ornamental Edibles

www.ornamentaledibles.com

Large collection of salad and braising greens, along with many other vegetables.

Osborne Seed Co.

www.osborneseed.com

Good selection of vegetables and herb seeds for the professional grower.

Redwood City Seed Co.

www.ecoseeds.com

Eclectic collection of heirloom and open pollinated varieties and huge selection of hot peppers.

Renee’s Garden Seeds

www.reneesgarden.com

Vegetable, herb, and flower seeds, great diversity geared principally toward gardeners.

Richter’s Herbs

www.richters.com

Extensive line of culinary and medicinal herb seeds; many varieties sold as young plants.

Seed Savers Exchange

www.seedsavers.org

Heirloom vegetable and flower seed, some bulk packaging and some organic offerings, commercial sales are an extension of non-profit network of membership organization.

Seeds from Italy/Franchi

www.growitalian.com

Many hard-to-find European vegetable varieties, and an extensive collection of chicories, untreated and mostly open pollinated offerings.

Siskiyou Seeds

www.siskiyouseeds.com

100% organic seeds, offering vegetables, grains, flowers, and herbs. All seed sources listed in catalogue.

Snow Seed Co.

snowseedcompany.com

Large selection of vegetable seeds, with many organic offerings, sold in bulk quantities for larger-scale production.

Southern Exposure Seed Exchange

www.southernexposure.com

Vegetable, herb, and flower seeds, geared especially for Atlantic seaboard growing conditions, seed saving supplies.

Sustainable Seed Co.

sustainableseedco.com

Large collection of small grains and vegetable seed, many organic varieties.

Territorial Seed Co.

www.territorialseed.com

Vegetable, flower, and herb seeds, garlic bulbs, some supplies, geared to smaller-scale growers.

Wild Garden Seed

www.wildgardenseed.com

100% organic and open pollinated seeds, many unique greens and other vegetables, with a focus on varieties geared to the Pacific Northwest.

PLUG/SEEDLING GROWERS AND BROKERS

Fred C. Gloeckner Co.

www.fredgloeckner.com

Broker

Germania Seed Co.

www.germaniaseed.com

Broker

Gro'n Sell

www.gro-n-sell.com

Grower of huge collection of annuals and perennials for cut flower and bedding plant production.

Growers Transplanting, Inc.

growerstrans.com

Vegetable transplant producer geared toward larger-scale producers.

Harris Seed Co.

www.harrisseed.com

Broker

Headstart Nursery

www.headstartnursery.com

Producer of vegetable and ornamental transplants for mid-scale and larger growers.

Ivy Garth

www.ivygarth.com

Broker

Pacific Plug and Liner

www.ppandl.com

Producer of huge selection of annual and perennial plugs.

Pioneer Gardens

www.pioneergardens.com

Producer of quality plugs and bareroot perennials.

C. Raker & Sons

www.raker.com

Growers of vast collection of annual and perennial plugs and liners.

Skagit Gardens

www.skagitgardens.com

Growers of an extensive of collection of annual and perennial plugs.

Speedling Inc.

www.speedling.com

Producer of vegetable transplants and many ornamentals for commercial growers.

SUPPLIERS

Agra Tech Inc.

www.agratesh.com

Manufacturer of greenhouses, high tunnels, and distributor of environmental controls systems, heating and cooling devices.

Anderson Pots

www.andersonpots.com

Manufacturer of a wide range of nursery pots, carrying trays, and heavy-duty plastic propagation flats. Products widely available through distributors listed on their website, direct sales to licensed resellers.

Carolina Greenhouses

www.carolinagreenhouses.com/page/page/1872691.htm

A supplier and manufacturer of a full range of greenhouse structures, environmental controls, germination chambers, Speedling trays.

Crop Production Services

www.cpsagu.com

A nationwide company supplying growers with fertility inputs, pest and disease control supplies, greenhouse films, weed barrier, cloth, growing containers. Supplier to both conventional and organic growers.

Farm Tek

www.farmtek.com

Distributor of greenhouses, high tunnels, heating and cooling equipment, controllers, and growing supplies.

Hummert International

www.hummert.com

Supplier of a huge array of equipment and supplies for greenhouse production, including germination chambers, soil media mixing equipment, vacuum seeders, wand seeders, bench systems, ventilation, heating and cooling equipment.

Johnny's Selected Seeds

www.johnnyseeds.com

Offers a wide range of tools and growing supplies.

J M McConkey

mcconkeyco.com

Manufacturer and distributor of nursery pots, paks, and carrying trays, lightweight plug trays, shade cloth, weed fabric, and environmental controls for greenhouses and high tunnels.

Peaceful Valley Farm Supply

www.groworganic.com

Supplier of a full range of materials to support organic growers: Tools, vegetable and flower seeds, cover crop seeds, fertility inputs, pest, disease, and weed control supplies, growing containers, bare root trees, garlic.

Speedling, Inc.

www.speedling.com/eps.html

Supplier of Speedling EPS plug trays direct from the manufacturer.

Stuewe & Sons

www.stuewe.com

Supplier of "conetainers," plug trays, propagation trays and vacuum seeder equipment. Geared toward the forestry industry, but widely applicable for greenhouse growing supplies.

Stuppy Greenhouse

www.stuppy.com

Greenhouses, high tunnels, glazing and shade cloth, control systems, heating and cooling, bench systems.

SUPPLEMENT 1

Examples of Cool- & Warm-Season Greenhouse Management in a Passive Solar Greenhouse

Greenhouses modify environmental conditions to optimize plant health and growth. In passive solar greenhouses, the greenhouse manager uses a combination of techniques to moderate temperatures, moisture levels, and air circulation. Here we offer some examples of cool- and warm-season greenhouse management methods used at the UC Santa Cruz Farm's greenhouses.

Cool Season Greenhouse Management

Sunlight, appropriate irrigation, temperature management, and air circulation are of paramount importance during the cooler period of limited sunlight.

SUNLIGHT

During the winter, prime plant growth by way of photosynthesis takes place principally between 9:30 am and 2:30 pm. While we cannot control the amount of sunlight available to plants during the cool season, we can optimize crop use of what light is available by working with the microclimatic differences within our greenhouse structures.

- The impacts of nearby trees, buildings, and greenhouse infrastructure may all be exaggerated in the winter and early spring; plants and containers should be placed so as to optimize growth.

- It may be necessary to turn flats/containers 180° 1–2 times per week to compensate for phototropism, the natural leaning of plants towards available sunlight. Phototropism is a common challenge in the winter due to the sun's low trajectory as it moves from east to west.

- Typically, recent prickouts (seedlings that have been transplanted to larger containers) don't need shade protection, and can be immediately returned to one of the greenhouses. However, if we are experiencing a heat wave or a pattern of intense sunlight, prickouts will need to be held over in the shade for 2–4 days to minimize transplant shock.

- If necessary, cleaning the glass/plastic glazing increases sunlight penetration.

WATERING

Cool season conditions dictate a more conservative approach to watering in order to ensure opti-

mal plant health. This is especially true during the ungerminated, germinating, and very young seedling stage of development.

- When the weather is consistently cool and/or overcast, water loss through the stomata and evaporation from the soil surface (together called evapotranspiration), water uptake by plant roots, and rates of plant growth are at a minimum. Thus, we can and should wait much longer between waterings.

- Allowing a more significant wet-to-dry swing of and near the soil surface is one of the primary cultural tools we have to prevent the presence and proliferation of damping off organisms. Once established, damping off fungi will kill many vulnerable species. Facilitating a wet-to-dry swing is absolutely critical for all large-seeded crops: Cucurbits, legumes, sunflowers, etc.

- Water is best delivered during the warmest portion of the day, usually between 11 am and 2 pm. Don't water first thing in the morning, to avoid dropping soil temperatures, or late in the day, also to keep soil temperature up and to allow time for some dry down before the air temperature drops.

- Water temperature should be approximately the same temperature as the air to avoid significant soil temperature fluctuations. Applying 45° water to 65° soil will cool soil significantly and rapidly. Soil temperatures are slow to rebound during the cool season, which slows down germination and root growth.

- Water lightly and more frequently—the opposite of the summer pattern. The only common exception is crops growing on bottom heat, such as the solanums, which are drying from above and below and thus need deeper, but less frequent watering.

- It is easier to go back and add more water if things are drying down quickly, but impossible to

“subtract” water if once your soil is overly wet. Under more extreme weather conditions it can take upwards of a week to achieve adequate dry down.

■ One watering a day is usually the maximum. Check depth of water penetration before and after watering, especially if flats are very dry.

TEMPERATURE MANAGEMENT

Temperature management in a passive solar structure is a balancing act between heating and cooling. Heating occurs via solar radiation/trapped air mass as dictated by available sunlight. Cooling happens by way of ventilation, or the importation of cool exterior air into the “heated” greenhouse environment.

■ Managing temperatures is a sophisticated art that requires careful attention to daily weather patterns, awareness of changes in sunlight intensity over the course of the day, and attention to fluctuations in outside air temperatures.

■ As greenhouse managers we must use this heightened awareness to manipulate venting appropriately, thus maintaining optimal temperature conditions within the greenhouse. In a greenhouse filled with diverse crops, target temperatures are:

Daytime temperature range: 60-80°

Optimal temperature: 65-75°, 70-85° for warm season crops

Nighttime temperature range: 55-60°

■ Temperatures greater than 50° are needed for steady/stocky growth.

■ Temperatures greater than 85°, if not sustained for more than a few hours, such as when vents are closed in the afternoon, should not be a problem. In fact, this spiking is necessary in a passive structure to allow for a buffer and the gradual dissipation of heat into the evening, rather than an abrupt drop in temperature as the sun passes off of the greenhouse.

■ Winter concerns: Too cool/too wet. Damping off occurs during extended wet and cool periods. **Always sacrifice air temperature in favor of air movement.**

VENTILATION/AIR CIRCULATION

Airflow is critical to avoid damping off, which can be a problem when we have consecutive cool, wet gray days with little day/night temperature fluctuation. 68°–86° is the optimal temperature for damping-off fungi to thrive. This is also approxi-

mately the optimal temperature range for warm season crops and close to the range for cool season crops. Always sacrifice air temperature in favor of air movement.

Cool season venting is more nuanced than in the summer. More frequent and slight adjustments are often necessary to balance proper airflow and maintain ideal temperatures.

Typical venting pattern on **cool/clear** days in Santa Cruz, California:

10:00-10:30: Open bottom vents and crack ridge vent to allow air circulation and prevent rapid temperature spiking

11:30-1:30: Adjust venting as necessary to maintain optimal temperatures and water as necessary

3:00-3:30: Close vents 1-half to 1 hour before sun moves off of the house. Exact timing will change as days lengthen

To maintain warmer temperature on cool, overcast or rainy days, venting will be minimal, but still crucial to facilitate air exchange and prevent the stale/dank conditions that allow damping off organisms to proliferate and prosper.

Typical venting pattern on **cool/overcast/rainy** days:

9:00-10:00: Crack ridge vent and open side vents for approximately one half hour

10:00-12:00: Water only if absolutely necessary

11:00-12:00: Again crack ridge vent and open side vents for approximately one half hour

1:00-2:00: Again crack ridge vent and open side vents for approximately one half hour

2:30-3:00: Close vents half to 1 hour before sun moves off of greenhouse. Exact timing will change as days lengthen. Do not water.

Horizontal Air Flow (HAF) fans should be on whenever vents are closed and always left on at night.

Typical venting pattern on **warm/clear** days:

9:00-9:30: Crack ridge vent and open side vents

10:00-11:00: Open ridge vent halfway to fully open, leave door wide open. Water as necessary or wait until midday.

12:00-1:00: If not already wide open, consider opening vents fully and deliver water as necessary

3:00-4:00: Close all venting and doors half to 1 hour before sun moves off of house. Exact timing will change as days lengthen.

ANTICIPATE—READ AND REACT

■ Close the greenhouse earlier when you anticipate cold nights. Closing early and the consequent temperature rise will help retain warmth longer into the night.

■ Be aware of 3–5 day weather forecasts to assist in venting and watering decisions. Check NOAA online weather information or other reliable source to help anticipate what to do and when to do it.

Warm Season Greenhouse Management

As with cool season conditions, maintaining a good wet-to-dry swing is critical during the warm season. Ventilation is the primary means to regulate temperature and maintain circulation.

WATERING

In summer, water plants as needed. As a general cultural practice, water earlier in the day so there is time for plants to dry down some before the evening while still having enough moisture to get through the night. If you are closing on a hot day and plants have dried down too much, water them as needed. If it is a plant susceptible to damping off, water conservatively.

There are 4 main watering “pushes”:

- Morning
- Midday (expect to water through lunch time)
- Mid Afternoon (3:00)
- Evening (5:00) on a HOT day

VENTILATION

Ventilation is the primary tool for cooling, so in warmer weather it is critical to proactively vent to keep temperatures from climbing. At its most basic, warm season venting simply involves opening and closing at the proper times. The recommendations below are intended as a guide. Use your senses, intuition, and knowledge of the current weather conditions as your primary indicator of what to do and when to do it.

Typical venting pattern on **warm/clear** days (65-75°):

By 8:30 am: Open the ridge vent to 6” and open sides

By 10:00 am: Fully open ridge vent and leave door wide open

5:30-6:00 pm: Close all venting and doors, knowing that temperatures will climb. Be sure plants have adequate moisture to get through the night. Be sure all side vents are closed and turn on HAF fans.

To maintain appropriate temperature on cool, overcast, or foggy days, venting can begin a bit later in the morning and may not require the ridge vents to be fully open, but venting is still crucial to facilitate air exchange and prevent the stale/dank conditions that allow damping off organisms to proliferate and prosper.

Typical venting pattern on **cool/overcast/foggy** days (50-65°):

9:00-ish am: Crack ridge vent to 6” and open side vents

11:00 am: Open ridge to halfway open

12:30-1:00 pm: Open ridge vent fully if inside temps are >75°

2:30-3:00 pm: Return ridge vents to halfway open

5:00-5:30 pm: Close all vents. Turn HAF fans on.

Typical venting pattern on **hot** days (outside temps predicted to be >80° and no fog):

By 8:00 am: Open side and ridge vents fully. Keep vents and doors wide open all day

As late as 6:30-7:30 pm: Close ridge and side vents. Turn on HAF fans.

Consider wetting down the floors to facilitate evaporative cooling if greenhouse temperature exceeds 90°.

Based on anticipated weather pattern, consider moving out all cool season crops, especially lettuces, brassicas, larkspur, stock, etc. to protect crops from thermodormancy and other heat-induced stress.

SUPPLEMENT 2

Conserving Water & Protecting Water Quality

A number of simple, straightforward, and easy-to-implement greenhouse practices will help conserve water and protect water quality while enhancing the health of your plants.

Water Conservation Tips

- Use a soil mix that includes ingredients such as compost and coco peat, which hold water effectively so that you don't have to irrigate as frequently. Just as with soil, you want a media that holds water but doesn't get waterlogged.

- Understand the natural cycling of water in your soil mixes, and how water use changes under different environmental conditions. By being aware of the rates at which your developing plants use water you can respond with sufficient irrigation but avoid overwatering.

- Water in advance of your plants' needs: early in the day when they can get fully hydrated and not lose water to evaporation. If plants are on outdoor benches, avoid watering during hot, windy conditions to minimize evaporation.

- Be conscious of the amount of water you're applying, especially to Speedling/plug trays and gallon pots. You need to wet the plants' roots but don't let excessive water run through the containers and onto the ground.

- "Block" or organize your trays of plants in the greenhouse by life stage and irrigation needs. Group those that can dry down between waterings and those that need more consistent irrigation.

- Leave a minimum of space between plant trays to limit watering empty tabletops and bare ground.

- Whatever your water delivery system (fixed spray, boom irrigation that moves on a track over the tables, or hose/watering can with a rose), make sure it is sized to match your tables/benches so that you're not spraying the walls and floors.

- Make sure to have shutoffs on all your hoses. In a greenhouse or outside, e.g., when irrigating potted up perennials, use "zonal shutoffs" for fixed irrigation systems so that you only water areas that have plants.

Water Quality Considerations

Using water efficiently and avoiding unnecessary runoff will also help protect water quality. But inevitably, there will be runoff from your greenhouse

operation. Consider implementing ways to protect water quality:

- Just as you do in the field or garden, try and meet the plants' nutrient needs without overfertilizing. Too much fertility can make your starts vulnerable to pests and diseases, as well as lead to nutrients lost in runoff water. To minimize nutrient loss from the soil mix of your perennials, use a stable, slow release nutrient source, e.g., compost.

- Some nurseries use an "ebb and flow" irrigation system; plants are set in a basin and wick water up from below. Once the plants are irrigated, the remaining water is drained off to reuse, thus saving water and "recycling" any leached nutrients. The potential drawback to this system in an organic operation is that if diseases are present there's a risk of spreading them amongst the plants.

- Water can pick up particulate matter from potting soil and other growing media and deposit it into your water supply; this is true of both organic and conventional mixes. Figure out where the runoff is going: Can it be directed to crops or non-crop vegetation that would benefit? For example, can it irrigate a windbreak or hedgerow that will cycle nutrients, rather than having nutrients running off site into surface or groundwater?

- Develop a system that captures all your runoff (greenhouse roof, benches, and floors, hardening off tables, outdoor sites where perennials are watered, etc.) and put it through a biofilter or sand filtration, store it in a pond or tank, and then reuse that same water. Although potentially expensive, such a system could be eligible for funding from the Natural Resources Conservation Service's Environmental Quality Incentive Program (EQIP) to encourage water conservation and protect water quality.

To minimize the risk of introducing pesticides and herbicides into the water supply, manage environmental conditions to reduce pests and diseases. Emphasize cultural controls and biological controls before using controls such as soaps, oils, and Neem (a broad spectrum insecticide and fungicide).

SUPPLEMENT 3

Low-Cost & Sustainable Alternatives to Traditional Greenhouse Propagation

Seed propagation is one of the most important—and potentially expensive—processes for a successful farm or garden. In agroecological systems that rely heavily on transplanting for some crops, continuous propagation in the greenhouse is crucial for successive cropping.

The greenhouses, growing containers, and growing media needed to grow healthy transplants are not only costly, adding to the already high initial capital investment required to begin a farming operation, but also use large quantities of non-renewable resources. As input costs and impacts continue to rise worldwide, farmers need to find alternative sources of energy and inputs to support their plant's growing needs.

Although many of the costs related to farming that make it financially risky are fixed or inelastic, meaning they are difficult to change (e.g., land rents, water costs, fossil fuel costs), there are some that can be minimized. Without easy access to government-subsidized credit, it is essential that organic farmers (new ones especially) minimize costs wherever possible to make their operation economically viable. Likewise, in urban areas where fixed costs may be even higher and access to raw materials and farmer know-how is limited, low-cost alternatives to traditional greenhouse propagation that include do-it-yourself options can mean the difference between success and struggle, and often provide more environmentally sustainable and socially just solutions.

Here are a few options for greenhouse propagation that reduce the costs, and in turn the barriers, to starting a farm or market garden.

Seed Saving

Seed saving not only reduces the cost of propagation, it provides adaptive on-farm benefits and preserves genetic diversity. Saving seed also embodies the philosophy of sustainability that guides agroecological farming. Seed costs, while not the largest operating expense on a farm, can be significant, especially when the cost of cover crop seed is factored in. Additionally, there is a price differential between conventional and organic seed—and organic seed for a number of varieties isn't always available, even from commercial organic seed companies.

Seed saving requires some botany and ecology knowledge to preserve varietal integrity. It also requires additional in-ground time commitment for most crops as well as the labor to harvest, process/clean saved seed.

As discussed in Supplement 1 in Unit 1.4, by saving seed you can select for plants adapted to local climate and soil features, and maintains genetic diversity in an era when genetic engineering and hybrid technology threaten crop diversity worldwide. By saving seed, farmers can lower overall operating costs as well as supply the farm with its own organic, locally adapted seed.

Seed saving can be a central part of developing a closed-loop system, minimizing external dependence and enhancing the process of community seed sovereignty. These benefits and challenges should be carefully weighed against the cost and convenience of buying seed from existing sources.

Passively Solar Heated Greenhouses

The greenhouse is by far the largest propagation-related investment for a farmer. Most commercial greenhouses are expensive to buy or have built, and often maximize only the sun's light energy while relying on fossil fuels in the form of electrically powered vents, fans, lights, heating tables, and thermostats to moderate heat. Passive solar greenhouses, on the other hand, are designed to maximize use of the sun's light and heat energy with little to no reliance on other sources of energy to control temperature or air circulation. Passive solar heating relies on maximizing sunlight during the day and then storing the trapped heat overnight using a thermal mass, usually large drums of water, blocks of stone, or gravel beds, within the greenhouse.

Besides their use of "free" energy from the sun, passive solar greenhouses are relatively inexpensive to build when compared to commercial greenhouses

and can be built by someone without extensive construction experience. Building a greenhouse independently not only reduces one of the few variable capital costs in starting a farm, but also allows the farmer to customize the design for her/his specific location, climate, and production goals.

Shared Propagation Infrastructure

For new farmers, and urban farmers in particular, finding the resources and in some instances the space for greenhouse propagation can be a challenge. Some farms contract with commercial nurseries or larger farms with available greenhouse space to grow their seedlings. While this may provide some benefits, including saving time, labor, and the need for propagation infrastructure, another approach is to share the costs of building and maintaining a greenhouse with other local farms or gardens. If no other farms in the area share this need, then finding a nearby greenhouse from which the farmer can borrow or rent space is an alternative.

While sharing greenhouse space may be logistically challenging, perhaps more so in rural areas than in urban areas, there are several benefits to this arrangement. Most importantly, each farmer can control her/his propagation process, materials, and irrigation. In urban settings, farmers and gardeners can use the greenhouse as a communal space to share information and techniques, as well as an educational resource on self-sufficiency for urban populations.

Sustainable Propagation Potting Mixes

Growing media used in propagation often rely on soilless mixes to minimize disease risks from soil borne pathogens. Unfortunately, the most common ingredients in these mixes often originate hundreds or thousands of miles off-farm and require environmentally destructive processes to produce (see Lecture 4). Standard mixes in organic agriculture (including those used at the CASFS Farm & Garden) include compost, sand, perlite, vermiculite, and coconut coir. Other than compost, all other materials are purchased as needed. Perlite and vermiculite are strip-mined materials and coconut coir is a by-product of coconut production, originating mainly in India and Sri Lanka. Aside from the added cost of purchasing off-farm inputs, these materials carry an embedded energy and environmental cost that detracts from the sustainability of an agroecological farm. While not yet certified for use in organic systems, Growstones offer one alternative to the widely used, but unsustainably sourced perlite in potting media. Lecture 4 describes additional materials that may be more sustainably sourced and serve the same function.

Glossary

Aeration

To add oxygen

Annual

A plant that completes its life cycle (germination through death) in one year or growing season, essentially non-woody

Asexual propagation

Propagation by vegetative means, rather than by seed. Not sexual, i.e., not involving the fusion of male and female sex cells.

Biennial

A plant completing its life cycle (germination through death) in two years or growing seasons (generally flowering only in the second) and non-woody (at least above ground), often with a rosette the first growing season)

Cell Tray

Multi-cell propagation container, also known as “plug tray”

Cotyledon

Seed-leaf; a modified leaf present in the seed, often functioning for food storage. Persistent in some annuals and helpful in their identification.

Cross pollination

The transfer of pollen from one flower to another, either on the same plant or between compatible plants, to effect fertilization and the seed development

Dicot

Flowering plant having two cotyledons (e.g., poppy, cactus, rose, sunflower)

Damping Off

A fungal pathogen whose populations are encouraged by consistently high moisture levels in the propagation media and high humidity. Negatively affect developing seedlings, often leading to lodging. Presence indicated by brown ring of compromised tissue around stem of plant. Often leads to losses.

Embryo

An immature plant within a seed

Endosperm

The starch- and oil-containing tissue of many seeds used by the seedling in the initial stages of development prior to the beginning of photosynthesis

F-1 Hybrid

A plant resulting from a cross between two genetically distinct individuals, which allows for the combination and expression of desirable traits in the F-1 generation

Fertigation

Fertilizer delivered through irrigation equipment

Fertilization

The use of concentrated forms of nutrients (e.g., fish emulsion to deliver soluble sources of nitrogen)

Hardening Off

The process of gradually exposing greenhouse-raised transplants to field conditions resulting in the development of more resistant and resilient seedlings

Imbibition

The process of water absorption by a dry substance or structure, causing it to swell

Monocot

Flowering plant having one cotyledon (e.g., lily, orchid, grass, cat-tail, palm)

Open pollination

The placing of pollen on a stigma or stigmatic surface by natural means, e.g., insect, wind, etc.

Perennial

A plant with a life cycle of more than two years

Photoperiodism

The response of a plant to the relative duration of day and night, especially in regard to flowering

Plumule

The young shoot as it emerges from the seed on germination, usually after the appearance of the radicle

Pricking Out

A traditional French-intensive method of raising seedlings in wooden flats, where seedlings are transplanted from a sowing flat at high density to a second propagation flat at lower density

Propagation Media

The growing media in which seeds are germinated and seedlings are grown

Radicle

The young root as it emerges from the seed, normally the first organ to appear on germination

Roguing

The selective removal of seedlings affected by pests or pathogens

Scarification

Scratching or etching a thick seed coat to improve water uptake

Self Pollination

Self pollination occurs when pollen is transferred from the anther to the stigma of the same flower

Sexual Propagation

The intentional reproduction of a new generation of plants by the germination and growth of seeds that were created in the previous generation through the fertilization of a plant ovary via the union of male and female sex cells. Results in a genetically unique plant generation.

Stratification

The exposure of ungerminated seeds to either warm or cold temperature extremes to release chemical dormancy factors

Transpiration

The loss of water vapor from a plant, mostly from the stomata of leaves

Viability

Capability of germination

Appendix 1: Characteristics of Open-Pollinated (OP) & Hybrid Seed

Open-pollinated seed is produced when the flowers are fertilized by pollen from within a genetically stable population. Offspring grown from open-pollinated seed bear traits or qualities that closely resemble the parent population. Open-pollinated seeds may come from:

Self-pollinated populations, which are typically of a stable homozygous genetic makeup, thus limiting problems of lack of vigor associated with inbreeding depression. Self-pollination occurs when pollen is transferred from the anther to the stigma of the same flower. This pollen germinates and grows down the style, to effect fertilization within the ovary of an individual flower.

Cross-pollinated populations, which are typically heterozygous in genetic makeup, and maintain their vigor and adaptability through the sharing of genetic information within a stable population. Cross-pollination within stable OP populations occurs when pollen is transferred between different flowers, either on the same plant or between compatible plants, to effect fertilization and the seed development. Cross-pollination may be carried out by insects, mammals, wind, water, or by hand. Cross-pollination can occur within a stable population, leading to predictable results, or it can occur when distinct but compatible populations cross, leading to less predictable results. The generation that results from this cross-pollination will display characteristics of the parent population, whether stable or distinct.

Advantages

- Genetic diversity within open-pollinated populations potentially provides a measure of naturally occurring resistance and adaptability to pests, pathogens, climate shifts, etc.
- By maintaining appropriate isolation procedures to preserve varietal integrity and adequate population sizes to prevent inbreeding depression and maintain vigor, open-pollinated seed of most crops can be easily and inexpensively produced and saved

Disadvantages

- In certain species uniformity, yield, and overall performance may not match that of hybrid varieties from F1 parent lines

F1 Hybrid seeds are the product of deliberate, controlled cross-pollination of two genetically different, but homogeneous, inbred, stable parent lines, each of which contribute enhanced, desirable characteristics to the subsequent F1 generation. Seeds saved from this next generation, the F2 filial line, typically possess a highly heterogeneous characteristics and will produce highly variable offspring unlike the hybrid parent population.

Advantages

Homogeneity, uniformity, and predictability of characteristics throughout the F1 population (for example: Vigor, uniformity, flavor, high yield, earliness, lateness, pest and/or disease resistance, fruit quality, storage ability, etc.)

Disadvantages

- If new pest or disease issues arise, the genetic uniformity of F1 hybrid populations may mean that the population lacks ability or the necessary resistance to adapt to new challenges
- Seed saved from F1 Hybrids will produce highly variable, unpredictable populations in the F2 generation
- In the F2 generation, populations typically display the full range of characteristics, both dominant and recessive, that were present in the parent lines used to create the F1 generation. While individuals within the F2 population may possess many desirable characteristics, uniformity and predictability of traits across the population will normally be absent.
- Complex, controlled breeding process and the need to maintain distinct parent lines makes it difficult for growers to produce and save their own F1 hybrid seeds
- The complexity and labor involved in maintaining distinct parent lines and in controlling pollination to produce seeds make F1 Hybrid seed more expensive to purchase

For more information on F1 hybridization, see the Royal Horticultural Society website:
www.rhs.org.uk/Advice/Profile?PID=710

Appendix 2: Seed Viability Chart

SEED TYPE	WITH NO SPECIAL STORAGE CONDITIONS (YEARS)	IN CONSISTENTLY COOL/DRY CONDITIONS (YEARS)
Beans, all	2–3	4 – 6
Beets	2	3 – 4
Broccoli	2	4 – 5
Brussels Sprouts	2	4 – 5
Burdock	2	4 – 5
Cabbage, regular	2	4 – 5
Cabbage, Chinese	3	5 – 8
Cantaloupe	3 – 4	6 – 10
Carrot	1 – 2	3 – 5
Cauliflower	2	4 – 5
Celery	1 – 2	3 – 5
Collard	2	4 – 5
Corn, all	1 – 2	4 – 6
Cucumber	3	5 – 7
Eggplant	1 – 2	3 – 5
Endive/Escarole	2	3 – 4
Kale	2	4 – 5
Kohlrabi	2	4 – 5
Leeks	up to 1	2 – 4
Lettuce	1 – 2	3 – 4
Mustard	2 – 3	5 – 8
Onion	up to 1	2 – 4
Parsley	1 – 2	3 – 5
Parsnip	up to 1	1 – 3
Peas	1 – 2	4 – 6
Pepper	1 – 2	3 – 5
Potato (true seed)	2 – 3	5 – 7
Pumpkin	1 – 2	3 – 5
Radish	2	3 – 5
Rutabaga	2	3 – 5
Salsify	2	3 – 4
Scorzonera	2	3 – 4
Spinach	1 – 2	3 – 4
Squash	1 – 2	3 – 5
Strawberry	2 – 3	3 – 6
Sunflower	2	4 – 6
Swiss Chard	2	3 – 4
Tomato	2 – 3	4 – 7
Turnip	2 – 3	5 – 8
Watermelon	2 – 3	4 – 6

Appendix 3: Soil Temperature Conditions for Vegetable Seed Germination

VEGETABLE	MINIMUM (°F)	OPTIMUM RANGE (°F)	OPTIMUM (°F)	MAXIMUM(°F)
Asparagus	50	60 – 85	75	95
Bean	60	60 – 85	80	95
Bean, lima	60	65 – 85	85	85
Beet	40	50 – 85	85	95
Cabbage	40	45 – 95	85	100
Carrot	40	45 – 85	80	95
Cauliflower	40	45 – 85	80	100
Celery	40	60 – 70	70 ¹	85 ¹
Chard, Swiss	40	50 – 85	85	95
Corn	50	60 – 95	95	105
Cucumber	60	60 – 95	95	105
Eggplant	60	75 – 90	85	95
Lettuce	35	40 – 80	75	85
Muskmelon	60	75 – 95	90	100
Okra	60	70 – 95	95	105
Onion	35	50 – 95	75	95
Parsley	40	50 – 85	75	90
Parsnip	35	50 – 70	65	85
Pea	40	40 – 75	75	85
Pepper	60	65 – 95	85	95
Pumpkin	60	70 – 90	90	100
Radish	40	45 – 90	85	95
Spinach	35	45 – 75	70	85
Squash	60	70 – 95	95	100
Tomato	50	60 – 85	85	95
Turnip	40	60 – 105	85	105
Watermelon	60	70 – 95	95	105

¹Daily fluctuation to 60° F or lower at night is essential.

Compiled by J.F. Harrington, Dept. of Vegetable Crops, University of California, Davis.

Source: *Knott's Handbook for Vegetable Growers*, by Donald Maynard and George Hochmuth, Wiley & Sons, Inc., 1997. Used by permission of Wiley & Sons, Inc.

Appendix 4: Days Required for Seedling Emergence at Various Soil Temperatures from Seed Planted 1/2-inch Deep

VEGETABLE	32°	41°	50°	59°	68°	77°	86°	95°	104°
Asparagus	NG	NG	53	24	15	10	12	20	28
Bean, lima	—	—	NG	31	18	7	7	NG	—
Bean snap	NG	NG	NG	16	11	8	6	6	NG
Beet	—	42	17	10	6	5	5	5	—
Cabbage	—	—	15	9	6	5	4	—	—
Carrot	NG	51	17	10	7	6	6	9	NG
Cauliflower	—	—	20	10	6	5	5	—	—
Celery	NG	41	16	12	7	NG	NG	NG	—
Corn, sweet	NG	NG	22	12	7	4	4	3	NG
Cucumber	NG	NG	NG	13	6	4	3	3	—
Eggplant	—	—	—	—	13	8	5	—	—
Lettuce	49	15	7	4	3	2	3	NG	NG
Muskmelon	—	—	—	—	8	4	3	—	—
Okra	NG	NG	NG	27	17	13	7	6	7
Onion	136	31	13	7	5	4	4	13	NG
Parsley	—	—	29	17	14	13	12	—	—
Parsnip	172	57	27	19	14	15	32	NG	NG
Pea	—	36	14	9	8	6	6	—	—
Pepper	NG	NG	NG	25	13	8	8	9	NG
Radish	NG	29	11	6	4	4	3	—	—
Spinach	63	23	12	7	6	5	6	NG	NG
Tomato	NG	NG	43	14	8	6	6	9	NG
Turnip	NG	NG	5	3	2	1	1	1	3
Watermelon	—	NG	—	—	12	5	4	3	—

NG = No germination, — = not tested

Adapted from J.F. Harrington and P.A. Minges, Vegetable Seed Germination, California Agricultural Extension Mimeo Leaflet (1954).

Source: *Knott's Handbook for Vegetable Growers*, 1997, John Wiley & Sons, Inc. Used by permission of John Wiley & Sons, Inc.

Appendix 5: Approximate Monthly Temperatures for Best Growth & Quality of Vegetable Crops

Some crops can be planted as temperatures approach the proper range. Cool season crops grown in the spring must have time to mature before warm weather. Fall crops can be started in hot weather to ensure a sufficient period of cool temperature to reach maturity. Within a crop, varieties may differ in temperature requirements; hence this listing provides general rather than specific guidelines.

OPTIMUM °F	MINIMUM °F	MAXIMUM °F	VEGETABLE
55°–75°	45°	85°	Chicory, chive, garlic, leek, onion, salsify, scolymus, scorzonera, shallot
60°–65°	40°	75°	Beet, broad bean, broccoli, Brussels sprouts, cabbage, chard, collards, horseradish, kale, kohlrabi, parsnip, radish, rutabaga, sorrel, spinach, turnip
60°–65°	45°	75°	Artichoke, cardoon, carrot, cauliflower, celeriac, celery, Chinese cabbage, endive, Florence fennel, lettuce, mustard, parsley, pea, potato
60°–70°	50°	80°	Lima bean, snap bean
60°–75°	50°	95°	Sweet corn, Southern pea, New Zealand spinach
65°–75°	50°	90°	Chayote, pumpkin, squash
65°–75°	60°	90°	Cucumber, muskmelon
70°–75°	65°	80°	Sweet pepper, tomato
70°–85°	65°	95°	Eggplant, hot pepper, martynia, okra, roselle, sweet potato, watermelon

Source: *Knott's Handbook for Vegetable Growers*, by Donald Maynard and George Hochmuth, Wiley & Sons, Inc., 1997. Used by permission of John Wiley & Sons, Inc.

Appendix 6: Examples of Propagation Containers

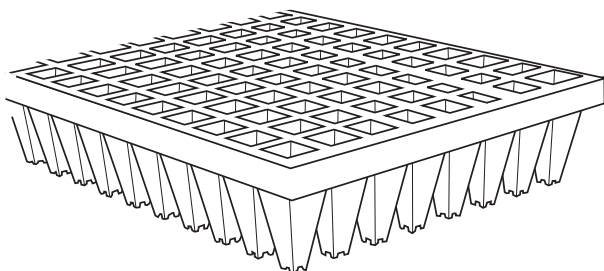

Cell Tray or Plug Tray

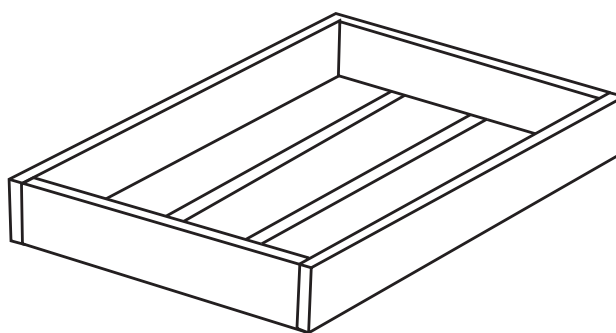

Wooden Flat

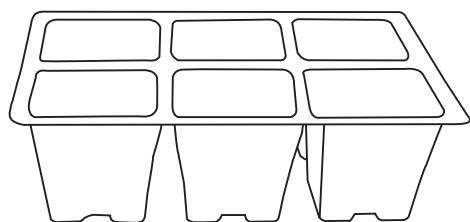

Six-Pack

Illustrations by Cathy Genetti Reinhard; not to scale

Appendix 7: Propagation Media— Ingredients & Properties Imparted

INGREDIENT	FUNCTION / QUALITIES IMPARTED	SOURCE	SUSTAINABILITY COSTS / COMMENTS
Peat Moss	<ul style="list-style-type: none"> • Fungistatic/acidic • H₂O-holding capacity 10 times dry weight 	Canadian peat bogs	\$\$\$ • pH 3.5–5.0 • Non-renewable by most counts
Perlite 5–8 lbs/cu ft	<ul style="list-style-type: none"> • H₂O-holding capacity 3–4 times dry weight • Aeration • Drainage 	Mined silica, volcanic origin Arizona	\$\$\$ • Non-renewable • No CEC ¹ • No nutrients • Energy intensive production
Vermiculite 6–10 lbs/cu ft	<ul style="list-style-type: none"> • Drainage • High CEC • H₂O-holding capacity 6–8 times weight • Has Mg/K 	Mica from Montana North Carolina	\$\$\$ • Energy intensive production • Non-renewable
Compost	<ul style="list-style-type: none"> • Moisture retention • Drainage • Nutrients • Pathogen suppression 	Produced on-site or purchased	Requires labor to produce • Potential source of weed seed
Soil	<ul style="list-style-type: none"> • Minerals • Minor NPK • Bulk density 	On-site	Free • Weed seed potential
Sand	<ul style="list-style-type: none"> • Drainage • Aeration 	Quarried, typically local	\$ • 0.05–2.0mm diameter • No CEC or nutrients
Leaf Mold (decomposed leaf litter)	<ul style="list-style-type: none"> • Serves as peat substitute • Acid/fungistatic • Drainage • H₂O-holding 	On-site	Free • Required labor to harvest if suitable material exists locally
Coir Fiber aka Coco Peat	<ul style="list-style-type: none"> • H₂O-holding • Drainage 	Coconut industry byproduct from Sri Lanka, Madagascar, Philippines, and India	\$\$ • Hard to handle/break up • Non-fungistatic • Travels far to Western market
Grape Seed Pomace	<ul style="list-style-type: none"> • Drainage • Aeration • K source • Minor N 	Winery byproduct	Time/labor • Perlite substitute for mixes • Could have high potassium

¹CEC = Cation Exchange Capacity (see Unit 2.2, Soil Chemistry and Fertility)

\$\$\$ = expensive input

\$\$ = moderately expensive input

\$ = low-cost input

Appendix 8: Sample Soil Mix Recipes

FLAT/SOWING MIX

3 parts compost (sifted .5 inch screen)
2 parts soil
1 part sand
2 parts coir fiber (premoistened) or 1 part coir fiber
+ 1 part leaf mold (sifted .5 inch screen)

GARDEN SPEEDLING MIX

2-1/2 compost (sifted .5 inch screen)
1 soil
2 coir fiber (premoistened) or 1 coir fiber + 1 leaf
mold (sifted .5 inch screen)

POTTING MIX

1-1/2 compost
1-1/2 partially decomposed duff
1 used mix
1 sand
1 grape pomace (or used mistbox mix)
1/2 soil

DRYLAND POTTING MIX

3 potting mix
1 sand
1 perlite (or used mistbox mix)
or
1 grape pomace

UCSC FIELD SPEEDLING MIX

2 compost (sifted .5 inch screen)
1 coir fiber (premoistened)
1 vermiculite (medium/fine)
3 cups blood meal*

*This amount of blood meal is based on when the
measure of one part is equal to a wheelbarrow.

LIQUID SUPPLEMENTAL FERTILIZER

Using watering can, per gallon of water:

1/4 cup liquid fish emulsion
1/2 tsp. Kelp powder

Using foliar sprayer:

Also add 1/4 tsp. sticker-spreader (surfactant),
added last into the tank to avoid excess foaming (see
Resources section).

In a bucket, mix ingredients with a small amount of
water, first making a paste to avoid clumping, and
then dilute with water for application. For basal
applications, remove spray nozzle end from sprayer
wand.

Fertigation, especially foliar applications, is best
done in the early morning or in the evening.

Appendix 9: Pricking Out Technique & Depth of Transplanting

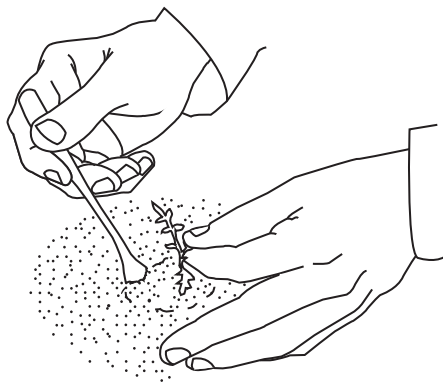

Gently prick out seedling from densely planted flat, carefully separating individual plants/roots

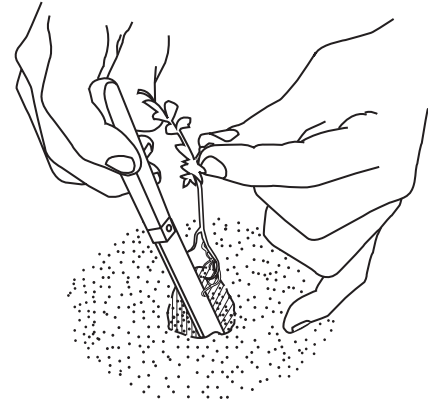

Place seedling in a new flat planted at lower density

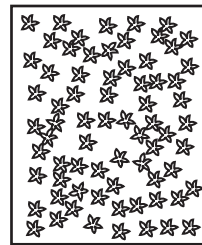

Plants sown at a high density (e.g., 200/flat) are pricked out into several flats at a lower density (e.g., 50/flat) to mature

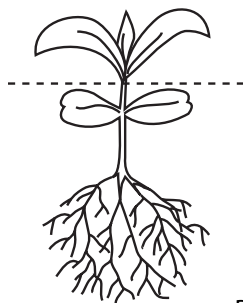
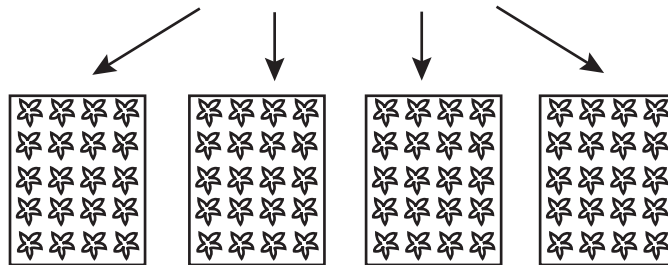

Proper transplanting depth

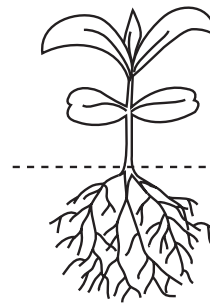
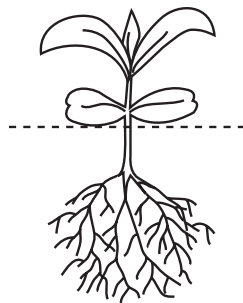

Improper transplanting depth

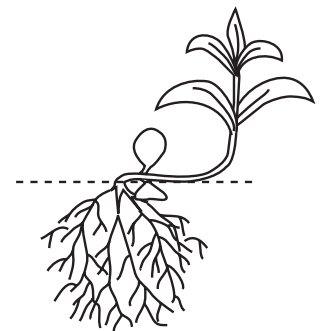

Illustrations by Cathy Genetti Reinhard; not to scale

Appendix 10: Flat-Grown & Cell-Grown Seedlings

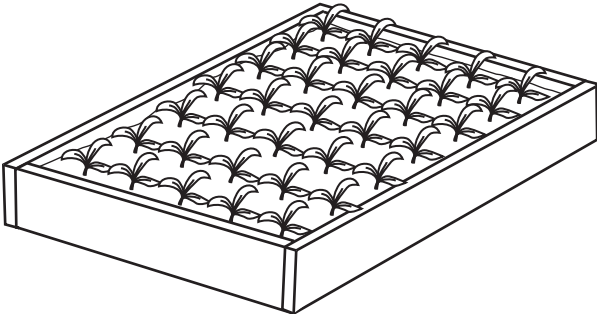

Flat-grown seedlings at transplant maturity —note balance of roots and shoots

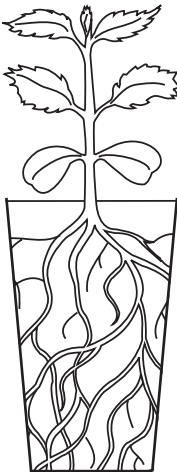
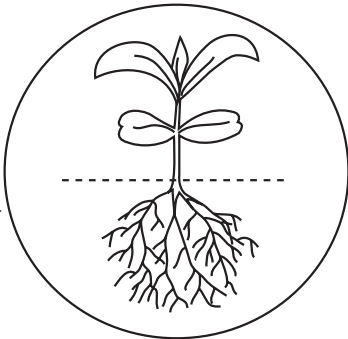
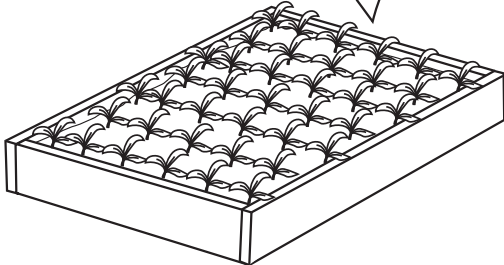

Cell-grown seedling at transplant maturity —note balance of roots and shoots with roots holding whole root ball together

Illustrations by Cathy Genetti Reinhard; not to scale

Appendix 11: Propagation & Crop Performance Records Sheet

CROP	DATE & AMOUNT SOWN	SEED CO. & SEED LOT / YEAR	COMMENTS ON GERMINATION & SEEDLING GROWTH	PRICKOUT DATE (IF APPL.)	TRANSPLANT DATE (TO FIELD)	1ST & LAST HARVEST DATES	YIELD INFO	OTHER

Appendix 12: Greenhouse Records Sheet

DATE/ TIME	PREVIOUS HIGH & LOW TEMP	CURRENT TEMP	WEATHER CONDITIONS	GREENHOUSE ENVIRONMENTAL CONDITIONS	MANAGEMENT ACTIONS TAKEN	OTHER

Transplanting and Direct Seeding

Introduction	167
Lecture 1: Transplanting and Direct Seeding	169
Demonstration 1: Garden-Scale Transplanting and Direct Seeding	
Instructor's Demonstration Outline	175
Students' Step-by-Step Instructions	179
Demonstration 2: Hand Transplanted and Tractor-Mounted Seeding Equipment	
Instructor's Demonstration Outline	183
Assessment Questions and Key	186
Resources	188
Supplement 1: Genetic Engineering and Seed Diversity: Impacts on Farmers and Agricultural Communities	189
Appendices	
1. Field-Scale Transplanting Guide	191
2. Common Transplant Spacings; Common Seeding Rates and Thinning Distances	192
3. Transplanting and Irrigation Equipment	194
4. Seedlings at Transplant Maturity; Planting Depths	196
5. Estimating Soil Moisture By Feel	197
6. Garden-Scale Seed Bed Irrigation	198
7. Garden Sowing Log	199
8. Garden Transplanting Log	200
9. Field Sowing Log	201
10. Field Transplanting Log	202

Introduction: Transplanting & Direct Seeding

UNIT OVERVIEW

Learning to recognize optimal soil moisture and weather conditions, grow and prepare healthy seedlings, properly prepare planting beds, and follow up with optimal irrigation, weed control, and plant protection are keys to successful transplanting and direct seeding.

In this unit, a short lecture compares transplanting and direct seeding, including the benefits of each; reviews the plant, soil, and environmental conditions to consider prior to transplanting and direct seeding; and briefly addresses post-transplanting/seeding practices. Two field demonstrations introduce students to the basic equipment and practices associated with direct seeding and transplanting techniques used in traditional French-intensive gardening, and in small- to medium-scale field production.

Refer to Unit 1.2, Garden and Field Tillage and Cultivation, and to Unit 1.3, Propagating Crops from Seed, and Greenhouse Management, for additional information relevant to the material presented here.

MODES OF INSTRUCTION

- > LECTURE (1 LECTURE, 45–60 MINUTES)
The lecture introduces the basic concepts associated with transplanting and direct sowing in the garden and field
- > GARDEN-SCALE TRANSPLANTING DEMONSTRATION (1–1.5 HOURS)
The garden-scale demonstration outline details the basic skills and concepts for direct seeding annual crops and transplanting both annual and perennial container-grown plants. Following the outline is a set of step-by-step instructions for students on seedling and soil preparation, direct seeding, and transplanting techniques.
- > ASSESSMENT QUESTIONS (0.5 HOUR)
Assessment questions reinforce key unit concepts and skills
- > POWERPOINT
See casfs.ucsc.edu/about/publications, and click on Teaching Organic Farming & Gardening.

LEARNING OBJECTIVES

CONCEPTS

- The optimal physical environment conditions favorable for successful transplanting
- The optimal soil moisture conditions favorable for successful transplanting
- The optimal seedling development and pre-treatments necessary for successful transplanting

SKILLS

- How to cultivate and prepare a bed appropriate for sowing seeds of various sizes or for transplanting starts
- How to sow small- and large-seeded crops using hand methods and push seeders
- How to transplant from a cell tray and flat format
- How to water-in/irrigate recently transplanted seedlings
- How to irrigate seed beds for optimal germination

Lecture 1: Transplanting & Direct Seeding

Pre-Assessment Questions

1. What is the difference between transplanting and direct seeding?
2. What are some of the reasons to transplant vs. direct seed crops?
3. What type of crops are better suited to transplanting vs. direct seeding?
4. Why do crops need to be “hardened off” prior to transplanting?
5. What are some of the environmental conditions most conducive to successful transplanting?

A. Transplanting versus Direct Seeding: Advantages and Appropriateness of Each Technique

1. Transplanting and direct seeding defined
 - a) “Transplanting” refers to the act of transferring seedlings from containers in the greenhouse (cell trays, flats, pots, etc.) into the garden or field
 - b) “Direct seeding” or “direct sowing” refers to planting seeds in the field to germinate in place
 - c) Note that there are no hard and fast rules about which crops are transplanted vs. directly sown; there are advantages and disadvantages to each method, and a number of factors will play into the decision regarding which approach to use. These include scale of planting, labor availability, length of season, types of seeders available, weed management capacity, and greenhouse and land availability. In some cases, transplanting a difficult-to-transplant crop can pay off if the market offers a premium for early harvest. See Appendix 1, Field-Scale Transplanting Guide, for recommendations regarding transplanting vs. direct sowing of various crops.
2. Transplanted crops
 - a) Advantages of starting crops in greenhouse
 - i. Greater climate control: Temperature, humidity, water
 - ii. Soil mix can be tailored to specific crop, as per fertility and drainage capabilities (see Appendix 8, Sample Soil Mix Recipes, in Unit 1.3, Propagating Crops from Seed, and Greenhouse Management)
 - iii. Offers protection from predators and elements: Wind, rain, birds, snails, etc.
 - iv. Greater season extension (can start crops earlier indoors)
 - v. Intensive rather than extensive management of seedlings: E.g., one 12” x 24” flat of leeks can plant a 4’ x 50’ bed with 6 rows at 6”/row (600 seedlings). Fewer resources—time, water, weeding, etc.—are required to care for 1 flat of leeks vs. 1 direct-sown bed.
 - vi. Weed management: Transplanted crops have a better chance at outcompeting weeds than seeds sown directly in the ground
 - b) Advantages of using greenhouse-grown transplants
 - i. Rapid crop successions (e.g., from cover crops to cropping and from one crop to another), as ground is not “tied up” with developing seedlings
 - ii. May allow for greater control over specific density of crops; save labor on thinning
 - iii. Get ahead of weeds (till in or “flame” weeds ahead of transplanting), thus saving labor on hoeing and weeding (see Unit 1.10, Managing Weeds)
 - iv. Conserves water: Less water required to irrigate transplants vs. irrigating seed beds
 - v. Fewer seeds needed to grow starts vs. direct seeding/thinning
 - vi. Creates better stand: Possible to have almost perfect establishment; less regular if thinning direct-seeded crops to a stand

- c) Root nature of transplanted crops: Fibrous roots transplant better than taproots (see Unit 1.3 for additional details)
 - d) Examples of transplanted crops: Lettuce, chard, kale, brassicas, fennel, tomatoes, peppers, fresh onions (in clusters), storage onions, basil (in clusters); at a garden scale, squash and cucumbers are often transplanted (see Appendix 2, Common Transplant Spacings; Common Seeding Rates and Thinning Distances for suggested spacings)
3. Direct-sown or seeded crops
- a) Advantages of direct seeding
 - i. Scale of production: Many crops are direct sown on a large scale to avoid costs associated with greenhouse production and transplanting
 - ii. Certain crops grow well at high density and/or are more easily harvested at high density, and are therefore better suited to direct sowing (e.g. cilantro, baby spinach)
 - b) Root nature of direct-sown crops: Often taprooted crops (e.g. beets, carrots, spinach, parsnips) are direct sown so as not to disrupt the taproot by transplanting
 - i. Exceptions: Most crops, including taprooted crops, may be transplanted if sown and transplanted in clusters
 - c) Intended density of crops: Direct-seeded crops require sowing at a high density and eventual thinning (see Appendix 2). Precision seeders, such as Earthway and Jang (pronounced “yang”), can help reduce the need for thinning in the garden. Other precision seeders used on a field scale include the John Deere 33 (for small seed) and John Deere 71 (for large seed). Stanbay seeders are commonly used in large-scale field production. See illustrations in Appendix 3, Transplanting and Irrigation Equipment.
 - d) Examples of direct-sown crops: Sweet corn, snap beans, carrots, beets, turnips, spinach, cilantro, dill
4. “Pelleted” seed
- a) Pelleted seed is used in both transplanting and direct sowing. It is coated with a clay-based material to make it larger, more uniform, and easier to handle.
 - b) Advantages and disadvantages of pelleted seed
 - i. The uniform size and shape of pelleted seeds makes them better suited for tractor-mounted or push seeders, as well as for vacuum seeders in a greenhouse
 - ii. The “pelleting” process decreases seeds’ length of viability; it is viable for a shorter time than raw seed
 - iii. Pelleted seed is more expensive than raw seed

B. “Hardening Off” Period Prior to Transplanting: What It Is and Why It’s Important

1. Hardening-off period (3–30 days) defined: “Hardening off” a transplant refers to making a gradual transition from greenhouse to outdoor field conditions
2. Physiological adjustments plant makes in the process of hardening off:
 - a) As seedlings are exposed to increased airflow (wind) and a greater temperature swing, the cells of the plant “toughen up.” Stems thicken and strengthen, making them more suitable to field conditions.
3. The hardening-off process:
 - a) Depending on environmental conditions, a hardening off period might start with bringing transplants outdoors for a few hours a day in mild conditions and bringing them in at night for a few days. The length of time the seedlings stay outdoors is increased gradually over a period of a week or a few weeks. In mild climates, a hardening off period of 3–4 days may be sufficient.

- b) Examples of hardening-off progressions:
 - i. From an enclosed greenhouse to an open-ended hoop house, and then to the field.
 - ii. From an enclosed greenhouse to tables or pallets under cover (e.g., shade cloth, plastic, or row cover) that can be rolled up during the day and rolled down at night in cooler temperatures, and then to the field

C. Assessments of Plant, Soil, and Environmental Conditions Prior to Direct Seeding or Transplanting

1. Seedling development necessary for successful transplanting
 - a) Shoot development: Generally 4–6 true leaves; for quick-growing plants such as lettuce and Asian greens, 2 sets of leaves may be adequate if there is adequate root development (“root knit”)
 - b) Root development: Roots should be well developed and branching. If started in a cell tray, roots should knit together in a well-formed unit that can hold up when pulled from the cell. In flats, roots should hold together in a root ball without dropping soil (assuming soil is wet). See Appendix 4, Seedlings at Transplant Maturity; Planting Depths for illustration of root knit.
2. Seedling pre-treatments necessary for successful transplanting
 - a) Soil/media moisture: With transplants started in cell trays or in flats, it is best to water thoroughly soon before transplanting (an hour or less)
 - i. Flat-grown seedlings: Planting media at 75–80% of field capacity
 - ii. Cell-grown seedlings: Seedling trays saturated (dripping wet)
 - b) Thorough watering helps the soil/root ball hold together, and gives the plant a boost before and during transplanting, which—even when done at optimum conditions—is still a disruptive event for young plants. By starting with wet roots, planting under optimum conditions and irrigating immediately/soon after transplanting, the “shock” of transplanting can be reduced.
 - c) Alliums are an exception—they can be “bare rooted” during transplanting, and therefore need drier soil in the cell tray or flat to allow the roots to be separated from each other and from the planting mix
3. Soil conditions favorable for successful transplanting or direct sowing (see Unit 1.2, Garden and Field Tillage and Cultivation, for more information on bed preparation)
 - a) Soil moisture: 75–80% of field capacity at a garden scale; 50–60% field capacity at field scale to avoid soil compaction when using planting equipment (see Appendix 5, Estimating Soil Moisture by Feel in this unit, and Unit 1.5, Irrigation—Principles and Practices, for more on field capacity)
 - b) Degree of secondary cultivation: Smaller seeds and small transplants such as lettuce require greater secondary cultivation, i.e. finer tilth. E.g., small-seeded crops such as carrot seeds need a finely tilled bed for seeds to have adequate soil contact, and for the cotyledons to penetrate the soil surface.
 - c) Large transplants, e.g., tomatoes and peppers, can handle less fine tilth as they will not have to push through the soil surface
4. Optimal physical environment conditions favorable for successful transplanting of flat-grown seedlings
 - a) Low light levels, e.g., cloudy or foggy conditions, or late afternoon/early evening. Planting late in the day gives the plant time to recover and adjust during a period of low transpiration (night and early morning hours).
 - b) Low temperatures: Plant in morning or later in afternoon to avoid exposing roots to the heat of midday
 - c) Low wind speed

- d) High humidity
 - e) As environmental conditions are rarely optimal, steps can be taken to reduce stress by having at least some, if not all, conditions right. E.g., if it is windy, wait until the temperature is cooler. Or if it is hot, wait until the wind dies down. Irrigating immediately after transplanting will help the plant recover from stress.
5. Irrigation must be ready to go prior to transplanting; at the field scale, make sure sprinklers or t-tape are set up before or immediately after transplanting takes place. Transplants must be watered in immediately after planting to establish root-soil contact and minimize transplant shock.

D. Additional Field-Scale Considerations

1. Incorporation of cover crop residue through primary tillage (see Unit 1.2, and Unit 1.6, Selecting and Using Cover Crops)
 - a) Mowing (flail or rotary)
 - b) Apply compost prior to residue incorporation, if necessary
 - c) Incorporate cover crop residue with spader or offset wheel disc
 - d) Wait an appropriate amount of time for cover crops to break down in the soil (irrigating can speed this process) so as not to plant into soil with partially-decomposed residue (usually 2–4 weeks, depending on soil moisture, temperature, and volume of cover crop residue)
2. Review field soil conditions prior to tillage
 - a) Soil moisture range: 50–60% of field capacity to avoid soil compaction
3. Establishment of seedbed through secondary tillage techniques
 - a) Rototill or disc field to improve surface uniformity following residue breakdown. Note that with some soils/implements, this step can be skipped. E.g., mechanical spading or multiple passes with a disk can act as both primary and secondary cultivation.
4. Bed formation
 - a) Form beds with lister bar and shovels or rolling cultivator
 - b) Shape bed with bed shaper (see Appendix 3)
 - i. In wet conditions (e.g., coastal California winters), raised beds can improve drainage
 - ii. In dry conditions, flat beds can minimize drainage
 - c) Pre-irrigate to germinate weed seed; if using drip tape, pre-irrigate 1 week in advance
 - d) Cultivate unplanted beds at as shallow a depth as possible with an under-cutter or “weeder” bar, sweeps, knives, or rolling cultivator to knock back the newly germinated weeds and reduce weed pressure. See Unit 1.10, for additional information.
 - e) Ensure good tilth: It is important for roots of transplants to have access to water held in soil pores; large clods don’t hold water
 - f) Plant beds with seeder, transplanter, or by hand

E. Post-Transplanting and Direct Seeding Considerations

1. Irrigation
 - a) Maintain adequate soil moisture for seeds and transplants: This is particularly critical for small, direct-seeded crops
 - i. Garden scale: Microsprinklers, oscillators, or a hose with a watering wand or “rose” attachment can be used to maintain surface soil moisture; seed beds should be watered when half the soil surface has dried (see Appendix 6, Garden-Scale Seed Bed Irrigation). At the depth of the transplant’s root ball (usually 2–4 inches deep) soil should be watered when it is at the edge of “balling up.” It’s better to apply water earlier than needed than to wait until the plant is stressed.

- ii. Overhead irrigation may be appropriate until field crops are established, at which point it may be appropriate to switch to drip irrigation to minimize water use and weed growth (see Unit 1.5)
 - iii. Large-seeded crops and large transplants can be planted to moisture following irrigation and weed cultivation; irrigation can then be delayed to allow the crop to get a jump on weed growth (see Unit 1.10)
2. Insect and mammal damage
- a) Floating row covers can be used for the first 2–3 weeks after crop emergence or transplanting to minimize or prevent damage by insect pests (e.g., flea beetles, cucumber beetles), birds, and mammals: Covers can be placed directly over the crop or draped over easy-to-make hoops and staked to form low tunnels. After 2–3 weeks crops are usually large enough, and have developed tougher, less succulent leaves, for the row covers to be removed (unless pest pressure is intense).
 - b) Row covers can also help “jump start” warm-season crops such as peppers early in the season and protect frost-sensitive crops at the end of the season
 - c) Nutrient needs: In spring, heat-loving crops growing in cool, wet soils may require supplemental fertility, as nutrients may not be readily available in these conditions. Supplements may include granular fertilizer (e.g. blood meal, feather meal) or liquid fertilizer (e.g., fish emulsion, liquid kelp) applied as a foliar spray or soil drench.

Demonstration 1: Garden-Scale Transplanting & Direct Sowing

for the instructor

OVERVIEW

The following demonstration outline covers the basic skills and concepts used to direct seed and transplant crops for garden-scale production. Following the outline below, discuss and demonstrate the tools and techniques used in garden-scale transplanting and direct seeding, as well as post-planting considerations (irrigation, pest control, etc.).

PREPARATIONS AND MATERIALS

- Recently prepared garden bed at 65–80% of field capacity, including a section prepared as fine/particulate surface soil for direct sowing of seeds and a section of less particulate surface soil for transplanting
- Flats of plants at transplanting maturity with well-developed root system (allium and broad-leaf crops)
- Cell tray at seedling maturity and immaturity
- Hand trowel and hand fork
- Watering wand
- Dibble (see Appendix 3, Transplanting and Irrigation Equipment)
- Measuring tape
- Rose and hose
- ½” poly line and micro-sprinklers (pre-assembled)
- String, string jig, and stakes (see Appendix 3)
- Large and small seed (e.g., peas/beans and carrots)
- Push seeders: Show different models, if available
- Bed end markers and indelible marker
- Appendices 7 and 8, Garden Sowing Log and Garden Transplanting Log

PREPARATION TIME

1.5 hours

DEMONSTRATION TIME

1.5 hours

DEMONSTRATION OUTLINE

A. Assess Plant, Soil, and Environmental Conditions Prior to Transplanting

Briefly review and assess the compatibility of the following environmental conditions and seedling maturity with the planned tasks, then demonstrate the following:

1. Seedling development necessary for successful transplanting
 - a) Shoot development
 - b) Root development
2. Seedling pre-treatments necessary for successful transplanting
 - a) Soil/media moisture
 - i. Cell-grown seedlings with media at field capacity
 - ii. Flat-grown seedlings with media at 75–80% of field capacity
 - b) Hardening-off period: A minimum of three days of full exposure to field conditions
3. Soil conditions favorable for successful transplanting or direct sowing
 - a) Soil moisture: Should be 75-80% of field capacity (see Appendix 5, Estimating Soil Moisture by Feel)
 - b) Degree of secondary cultivation: Smaller seeds require greater secondary cultivation
4. Optimal physical environment conditions favorable for successful transplanting of flat-grown seedlings
 - a) Low light levels
 - b) Low temperature
 - c) Low wind speed
 - d) High humidity
 - e) Steps to take if environmental conditions are not optimal (see Lecture)

B. Demonstrate Transplanting

1. Plant spacing: Talk about the way the following factors influence crop spacing
 - a) Pre-irrigation and cultivation considerations
 - b) Root and shoot size at maturity: Include depth and spread
 - c) Disease prevention/air circulation
 - f) References: See Appendix 2, Common Transplant Spacings; Common Seeding Rates and Thinning Distances of this unit, and Resources section of Unit 1.3, Propagating Crops from Seed, and Greenhouse Management
2. Tools used to assure uniform plant spacing: Demonstrate tools used to guide planting
 - a) Parallel lines of string between stakes
 - b) String jig
 - c) Transplant marker, e.g., dibble
 - d) Triangulation
 - e) One's hand
3. How to plant: Demonstrate the following
 - a) Knowledge of crop being planted
 - b) Plant selection criteria (development and vigor of seedling)
 - c) Plant handling technique
 - d) Depth of planting (see Appendix 4, Seedlings at Transplant Maturity; Planting Depths)

4. Watering in: Demonstrate why, how, and irrigation options
 - a) Why? To assure even soil moisture between transplant and surrounding soil in order to assure uninterrupted regrowth
 - b) Options for how to irrigate after transplanting (water in)
 - i. Basal application with watering wand
 - ii. Overhead sprinkler and considerations of scale
 - iii. Microsprinkler
 - iii. Overhead sprinkler, transition to drip irrigation
5. Documenting
 - a) Demonstrate documenting as learning tool
 - b) Where to document?
 - i. Field or bed marker
 - ii. Garden log book with crop seeding and transplanting dates, variety, and seed company (see Appendices 7 and 8)
6. Post-transplant follow up
 - a) Irrigation
 - i. Method of irrigation: Microsprinklers, oscillators, hand watering
 - ii. Monitoring root zone for 50–60% of field capacity: At the depth of the root ball (usually 2–4 inches deep) soil should be at the edge of “balling up.” It’s better to apply water earlier than needed than to wait until the plant is stressed.
 - b) Observations of subsequent growth. Discuss the following considerations:
 - i. Predation: Monitor seedlings for insect or pest damage. Replace as needed. Use remay or other floating row cover to protect seedlings from insects (e.g., flea beetles on brassicas and eggplants, cucumber beetles on cucurbits) and from bird and mammal damage.
 - ii. Nutrient needs: In spring, heat-loving crops growing in cool, wet soils may require supplemental fertility such as granular fertilizer (e.g. blood meal, feather meal) or liquid fertilizer (e.g., fish emulsion, liquid kelp) applied as a foliar spray or soil drench
 - iii. Root development: Carefully digging up seedlings to observe root development provides information for depth of irrigation requirements
 - c) Excess/replacement seedlings
 - i. Management of excess seedlings in propagation area: If necessary, pot up “extra” plants to maintain/extend their viability
 - ii. Treatment: Supplemental fertility may be required to sustain replacement seedlings

C. Discuss and Demonstrate Direct-Sowing Techniques

1. Briefly review optimal environmental considerations for seed germination
 - a) Soil moisture should be 65–80% of field capacity
 - b) Degree of secondary cultivation: Describe here, talk about differences between needs of small vs. large seeds
 - c) Soil temperature: For warm-season crops, surface soil temperature should exceed 60° in the top 6 inches for majority of daylight hours
 - d) Depth of planting: General rule is to plant seeds twice as deep as the seeds are long. Refer to seed packets or seed catalogs as reference

2. Demonstrate and discuss the pros/cons of the various direct-sowing techniques
 - a) Drills/sowing into furrows by hand
 - b) Push seeder: Demonstrate multiple types, if available
 - c) Broadcast sowing
3. Irrigation
 - a) Objective: For small-seeded crops (e.g., lettuce, salad mix, carrots), maintain even soil moisture until seed germination, when the oscillation between wet and dry can be stretched gradually. Larger-seeded crops (e.g. peas, squash, seed potatoes) can tolerate more of a wet-dry swing from the time they are planted; overwatering can lead to rot.
 - b) Techniques and frequency used
 - i. Micro sprinklers
 - ii. Overhead sprinklers
 - iii. Dripline
 - iv. Discuss flow rates of each system in regards to frequency
4. Thinning established stand
 - a) Stage of development: Discuss when to thin
 - b) Density: See Appendix 1, Field-Scale Transplanting Guide
5. Questions and answers

Demonstration 1: Garden-Scale Transplanting & Direct Sowing

step-by-step instructions for the students

A. Assess Plant, Soil, and Environmental Conditions *Prior* to Sowing or Transplanting

1. Seedling development
 - a) Shoot development
 - i. Second set of true leaves (cell format)
 - ii. Filling out allotted space and second set of true leaves established (flat format)
 - b) Root development
 - i. Root knit (cell format)
 - ii. Filling out allotted space (flat format)
2. Seedling pre-treatments
 - a) Soil/mix moisture
 - i. Field capacity (cell format)
 - ii. 75%–80% of field capacity (flat format)
 - b) Hardened-off
 - i. 3–21 day range (minimum of 3 days with 24 hours at field conditions)
 - ii. Hardening-off period should increase in duration with increased differential between field and greenhouse conditions
3. Field or garden soil conditions
 - a) Soil moisture
 - i. 75–80% of field capacity
 - b) Degree of secondary cultivation
 - i. Extensive secondary cultivation for small-seeded, direct-sown crops and transplants with small, weak, or inefficient root systems (e.g., carrots)
 - ii. Slightly less secondary tillage for large, vigorous, and resilient transplants (e.g., tomatoes, peppers)
4. Optimal environmental conditions favorable to successful transplanting from flat format
 - a) Low light levels
 - b) Low temperature
 - c) Calm winds
 - d) High relative humidity
 - e) Late afternoon and early evening

Note that you will seldom have all of these conditions in place; see information in lecture outline for ways to compensate for less-than-ideal transplanting conditions

B. Transplanting

1. Gather necessary tools and materials
 - a) Seedlings at transplant maturity
 - b) Hand trowel and hand fork
 - c) Watering wand
 - d) Dibble or other transplant marker

- e) String jig
 - f) Measuring tape
 - g) Ross and hose
 - h) Micro-sprinklers
 - i) String and stakes
 - j) Seed
 - k) Push seeders (if available)
2. Plant spacing considerations: Consider how the following factors influence crop spacing
 - a) Irrigation and cultivation considerations
 - i. Rows should be straight and between-row crop spacing should be large enough to accommodate drip irrigation line and cultivation tools
 - b) Root and shoot size
 - i. How large is the root system and vegetative portion of the plant at maturity?
 - c) Stem length and stem number in cut flowers
 - i. By increasing crop density in certain cut flowers, flower stem lengths may be increased.
 - d) See Appendix 2, Common Transplant Spacings; Common Seeding Rates and Thinning Distances, for recommendations
 3. How to plant
 - a) Know the crop being planted
 - i. Review the crop culture information on the back of the seed package, in seed catalogues, online, or in books on crop culture
 - b) Plant selection criteria (seedling vigor): Select for vigor
 - c) Plant handling
 - i. Crops grown in a flat format should be handled carefully by the rootball, attempting to disturb the root system as little as possible during the transplanting process. Crops grown in a flat format should only be transplanted during the late afternoon/early evening or on cloudy days.
 - ii. Crops grown in a cell tray format may be planted throughout the day and with less concern for disturbance of the root system during planting
 - d) Depth of planting
 - i. Most crops should be planted to the depth of the cotyledons (see Appendix 4, Seedlings at Transplant Maturity, Planting Depth)
 - ii. Crops in the Solanaceae family (tomatoes, peppers, eggplants, etc.) and Brassicaceae family (broccoli, cabbage, cauliflower, etc.) are adventitious rooters and may be buried to the bottom of the first set of true leaves
 4. Watering in
 - a) Seedlings should be immediately irrigated following transplanting
 - b) Bring the root zone of the crop to saturation (all pore spaces filled) using drip irrigation, overhead sprinklers, micro sprinkler, or basal soaking with a watering wand or rose
 5. Documenting
 - a) Transcribe the information on the horticultural label (including the transplanting date) to a bed-end stake and the garden record log book (see Appendix 8)
 6. Follow-up
 - a) Determine the type of irrigation to be used and set up any necessary irrigation equipment at this time

- b) Return remaining seedlings to the propagation area. Refill flats with propagation mix and water thoroughly
- c) Over the following approximately 2–5 days, monitor soil moisture in the root zone of the recently transplanted crop. Irrigate once the soil in the root zone has reached 50–60% of field capacity; at the depth of the root ball (2–4" deep) the soil should be right on the edge of not "balling up" when squeezed. Note that it is better to water too early than to stress new transplants by underwatering.
- d) Periodic, light overhead irrigation will raise the relative humidity around the seedlings, reduce the rate of evapotranspiration, and help minimize transplant shock
- e) Observe the growth and development of the roots and shoots of the seedlings, noting the following: Rates of growth, changes in color, and damage due to predation
- f) Replace seedlings lost to predation. Use remay or other floating row cover to protect seedlings from insect damage, as appropriate

C. Direct Sowing

1. Consider the optimal environmental conditions for seed germination in terms of:
 - a) Soil moisture
 - i. 75%–80% of field capacity
 - b) Degree of secondary cultivation
 - i. Extensive secondary cultivation is necessary for small-seeded direct-sown crops and transplants with small, weak, or inefficient root systems
 - c) Soil temperature
 - i. Compare the existing soil temperatures with the optimal germination temperatures found on the back of the seed package, in Knott's Handbook for Vegetable Growers, or in Appendix 2, Seed Viability Chart, of Unit 1.3, Propagating Crops from Seed, and Greenhouse Management
2. Direct-sowing techniques
 - a) Sowing into furrows with hands
 - i. Open furrow with fingers or hand tool to a depth of approximately 2 times the diameter of the seed to be sown
 - ii. Sow seed at 2–3 times the density desired at maturity (seedlings are later thinned to desired spacing when the first set of true leaves have developed)
 - iii. Cover seed by pinching furrow together
 - iv. Gently tamp soil with head of rake to assure soil-to-seed contact
 - b) Sowing into furrows with push seeder
 - i. Consult the seed plate chart for use of push seeder
 - ii. Test seeder output on hard, flat surface to confirm desired seed rate/spacing
 - iii. Periodically check to assure seed output and seed supply in hopper
 - c) Broadcast sowing
 - i. Broadcast evenly over surface of soil
 - ii. Cover lightly with a mixture of 50% garden soil and 50% mature compost
3. Irrigating seed beds
 - a) Using Ross, oscillator, or mist/micro-sprinklers, maintain surface soil moisture with light, frequent applications of water each time 50%–100% of the surface of the soil has dried and discolored (see Appendix 6, Garden-Scale Seed Bed Irrigation)
4. Thinning direct-sown crops
 - a) Thin directly seeded crops to desired spacing, if necessary, once the first set of true leaves has developed (see crop-spacing chart in Appendix 2 and in seed packages and catalogues)

Demonstration 2: Field-Scale Transplanting & Tractor-Mounted Seeding

for the instructor

INSTRUCTOR OVERVIEW

This field demonstration outline introduces the tractor-mounted equipment and skills used to transplant and direct seed crops. It first covers the sequence of techniques and equipment used to prepare the soil for both transplanting and direct seeding. The outline then introduces the range of equipment and techniques used to transplant and direct seed crops, followed by irrigation techniques.

PREPARATION AND MATERIALS

- Bed shaper/marker
- Tractor-mounted seeder
- Push seeder
- Plate planter
- Tractor-mounted transplanting equipment
- Hand trowels
- Irrigation equipment: Drip and sprinkler
- Record sheets for recording crops sown, and planted (see Appendices 7 and 8)
- Labels for marking bed
- Shovels for single row plantings

GROUND PREPARATION

This demonstration requires access to an area of ground that has received primary and secondary tillage, pre-irrigation, and weed cultivation. These techniques should be included in the demonstration if not covered previously in Unit 1.2, Garden and Field Tillage and Cultivation.

PREPARATION TIME

1 hour

DEMONSTRATION TIME

1 hour

DEMONSTRATION OUTLINE

A. Review and Discuss Tools and Sequence Used to Prepare Ground

1. Review field soil conditions prior to tillage
 - a) Soil moisture range: 50%–60% of field capacity (see Appendix 5 in this unit, and Unit 1.5, Irrigation—Principles and Practices, for discussion of field capacity)
2. Review steps involved in incorporation of cover crop residue through primary tillage
 - a) Mowing (flail or rotary)
 - b) Apply compost prior to residue incorporation, if necessary
 - c) Incorporate cover crop residue with spader or off-set wheel disc (see Unit
3. Establishment of seedbed through secondary tillage techniques
 - a) Rototill or disc field to improve surface uniformity following residue breakdown
4. Review steps involved in bed formation
 - a) Form beds with lister bar and shovels or rolling cultivator
 - b) Shape bed with bed shaper
 - c) Pre-irrigate to germinate weed seed; if using drip tape, pre-irrigate one week in advance
 - d) Cultivate unplanted beds with sweeps, knives, or rolling cultivator to minimize weed pressure and exhaust seed bank
 - e) Ensure good tilth: Important for roots of transplants to have access to water held in soil pores; large clods don't hold water
 - f) Plant beds with seeder, transplanter, or by hand

B. Demonstrate Bed Shaper/Seeder for Direct-Sown Crops

1. Review attachment of implement(s)
2. Demonstrate adjustment of bed shaper height
3. Demonstrate adjustment of seeder shovels' height for seeding various crops
4. Demonstrate using markers on bed shaper to pull scratch lines for guiding straight planting
5. Review examples of crops that are directly sown and why

C. Demonstrate Implements Used to Prepare Beds for Single-Line Plantings

1. Review attachment and adjustment of implement(s) used
2. Review examples of single-line crops

D. Review Planting Plan

1. Prepare planting map: Calculate how many feet of which crop will be planted (and where), and have map ready for planting crew
2. Prepare list of plants to pick up from hardening-off area

E. Review Preparation for Transplanting

1. Transplant preparations: Irrigation and hardening off (see Unit 1.5, and discussion of hardening off in this unit)
2. Ensure that transplants are ready: Knit together root plug, hardened off for one week, firm stems, roots that are not wrapped
3. Planting considerations to minimize transplant shock
 - a) Plug trays should be saturated (dripping wet) prior to planting
 - b) Soil should be pre-irrigated

- c) Plant in cool of the day, or going into cool; e.g., in Central Valley, plant late afternoon
- d) Leave trays in shade if not planting immediately
- e) Reschedule planting if extremely hot or windy
- f) Have irrigation ready to turn on as soon as planting is done and before plants stress; note that for sprinkler irrigation, planting block is equal to irrigation block

F. Review Hand Transplanting Techniques

1. Review of transplanted crops
 - a) Single line crops (tomatoes, peppers, eggplant, squash, melons, cucumbers)
 - b) Double line crops (brassicas, lettuce, celery, onions, leeks)
2. Handling and placement
 - a) To remove plants from plug trays, grasp stem firmly or drop tray on flat ground to loosen plugs
 - b) Work in teams: one person drops plant in furrow, one person plants
 - c) Drop and plant one line at a time (i.e., don't try and cover both lines of a raised bed)
 - d) Pay attention to designated spacing (i.e., 8", 12", etc.) and stay in scratch line so plants don't later get cultivated out during mechanical cultivation
 - e) Don't leave plugs on soil surface for longer than 3–5 minutes
 - f) Planting depth: Cover plug entirely (Note: Sometimes, plants are placed on their side if stems are leggy, e.g., tomatoes, sunflowers; or plant up to cotyledons, e.g., broccoli)
 - g) Avoid planting plug above air pockets

G. Demonstrate the Use of Mechanical Transplanter

1. Review attachment of implement(s)
2. Demonstrate adjustment of transplanter
3. Transplant preparations: Review irrigation and hardening off
4. Demonstrate handling and placement of transplants
5. Review examples of crops that are mechanically transplanted and why
6. Demonstrate adjustment of transplanter

H. Review Irrigation Techniques Used Immediately Following Transplanting and Direct Seeding

1. Drip irrigation
2. Sprinkler irrigation: Irrigation pipe is ready to hook up, pump is tested, etc.
3. Note that if block is mixed between direct sown and transplanted crops, direct sow first so that water can be turned on as soon as transplants are in the ground

I. Demonstrate Clean Up

1. Wash out plug trays and sun-sterilize

J. Review Record Keeping

1. Record information on bed-end stakes (cultivar, planting date)
2. Record information in field logs (see Appendices 9 and 10)

Assessment Questions

- 1) List three physical environmental conditions favorable for successful transplanting of flat-grown seedlings.

- 2) What is the optimal range of soil moisture for transplanting or direct seeding of crops?

- 3) Describe how the size, root nature, and vigor of transplants and the size of seeds influence the degree of secondary cultivation needed.

- 4) List two characteristics of seedlings at transplanting maturity.

- 5) List two necessary steps in preparing seedlings for transplanting.

Assessment Questions Key

- 1) List three physical environmental conditions favorable for successful transplanting of flat-grown seedlings
 - *Low light levels*
 - *Low temperature*
 - *High relative humidity*
 - *Calm winds*
- 2) What is the optimal range of soil moisture for transplanting or direct seeding of crops in the garden? In the field?
 - *Garden: 75–80% of field capacity*
 - *Field: Between 50%–60% of field capacity (lower in order to minimize compaction from equipment)*
- 3) Describe how the size, root nature, and vigor of transplants and the size of seeds influence the degree of secondary cultivation needed
 - *Directly sown crops (especially small-seeded crops) require extensive secondary cultivation in order to reduce the surface soil particle size and produce a quality seed bed. Small, inefficient, weak, or shallow-rooted crops (e.g., onions, leeks, lettuce) also respond favorably to being transplanted into soils having received extensive secondary cultivation.*
 - *Large, vigorous transplants may be transplanted into more coarsely tilled soils*
- 4) List two characteristics of seedlings at transplanting maturity
 - *Second set of true leaves initiated*
 - *Root knit*
- 5) List two necessary steps in preparing seedlings for transplanting
 - *Pre-moistened to 75–80% and 100% of field capacity (flats and cell tray transplants respectively)*
 - *Hardened-off for 3–21 days*

Resources

PRINT RESOURCES

Coleman, Elliott. 1995. *The New Organic Grower: A Master's Manual of Tools and Techniques for the Home and Market Gardener, 2nd Edition*. White River Junction, VT: Chelsea Green Publishing.

The classic introduction to small-scale organic vegetable production. Includes sections on direct seeding, transplanting, and using soil blocks.

Maynard, Donald M., and George H. Hochmuth. 2006. *Knott's Handbook for Vegetable Growers, 5th Edition*. Hoboken, New Jersey: John Wiley & Sons.

A widely used reference book designed for commercial vegetable growers. Includes basic information on planting rates, schedules, and spacing of myriad vegetable crops.

Fortier, Jean-Martin. 2014. *The Market Gardener: A Successful Grower's Handbook for Small-Scale Organic Farming*. Gabriola Island, BC: New Society Publishers.

Includes a section on starting seeds indoors and direct seeding.

Volk, Josh. 2009. *Tools That Make Direct Seeding Easier*. Growing for Market. www.growingformarket.com/articles/20090428_6

WEB-BASED RESOURCE

USDA, Natural Resources Conservation Service. 1998. Estimating Soil Moisture by Feel and Appearance. Program Aid Number 1619.

www.ext.colostate.edu/sam/moisture.pdf

Describes techniques for using the “feel and appearance” method to estimate soil moisture content and schedule irrigation.

SUPPLEMENT 1

Genetic Engineering & Seed Diversity: Impacts on Farmers & Agricultural Communities

Seed saving has been an integral component of agriculture throughout history. Starting with humankind's earliest efforts to domesticate wild plants, farmers around the world grew crops by saving and replanting seeds from the previous season. Almost universally viewed as a shared resource entrusted to the public, farmers have always enjoyed the freedom to save, breed, replant, and exchange seeds, resulting in the great diversity of plants we rely on for food and fiber around the world.

Genetic diversity among seeds is vital not only to the resilience of plants, but also to the resilience of communities that depend on plants for their livelihoods.

Both crop diversity and farmers' freedom to grow crops of their choice have been severely diminished in the last eight decades, as production agriculture's focus on high yield intensified and as patent law gave agrichemical companies private patent rights to seeds. Today, global crop diversity is shrinking as the worldwide adoption of patented, genetically engineered (GE) seeds accelerates. GE varieties are quickly becoming dominant in commodity crop agriculture in many countries. As of 2009, 90 percent of corn, 84 percent of soybean and cotton, and 64 percent of canola grown in the United States is from GE seed.¹

As a consequence of changes to U.S. patent law in 1980, seeds were, for the first time, subject to patents and ownership by individuals or corporations. Nearly all GE and hybrid seeds are now patented and owned by the companies that sell the seeds commercially. As of 2009, five companies (Monsanto, DuPont, Dow, Bayer, and Syngenta) accounted for 58% of global commercial seed sales.²

Dramatic increases in seed prices have accompanied seed industry consolidation, due in part to technology fees on GE seeds that companies can charge with their increased market share. Farmers who buy

GE seeds are also required to sign technology use agreements (TUGs), essentially legally enforceable contracts, limiting how the seed is used, to whom it is sold or transferred, and what it can be used for. Most TUGs prohibit research trials using GE seed or comparing yield performance between GE and other seed. Nearly all TUGs prohibit seed saving, requiring farmers to purchase new seed each year.

To enforce the restriction on seed saving, one company in particular, Monsanto, employs 75 or more investigators with a budget of \$10 million to aggressively patrol and sample crops from farmers' fields to test for unauthorized use of their GE seeds.³ Any unauthorized use of its seed—intentional or not—is considered patent infringement, thus giving Monsanto a financial incentive to police farm communities. Indeed, the company has sued nearly 150 farmers in several U.S. states for infringement, resulting in 72 recorded judgments totaling \$24 million and an estimated \$80–160 million more in out-of-court settlements against farmers⁴ (see also Unit 3.2, Social Issues in Current U.S. Agriculture, Lecture 2). The other seed companies mentioned above engage similar tactics against farmers who save their patented seeds.

India has also seen drastic impacts on farmers as a result of GE seed use. GE cotton was introduced to Indian farmers in 2002 as part of new development policies aimed at stimulating economic growth. By 2009, nationwide adoption of GE cotton reached 85 percent, with rates as high as 95 percent in some states. While crop yields initially rose, the new varieties, owned and licensed by Monsanto, increased monetary and resource costs for cash-strapped Indian farmers with limited access to water.

1 USDA Economic Research Service. Genetically engineered varieties of corn, upland cotton, and soybeans, by State and for the United States, from 2000–14. www.ers.usda.gov/data-products/adoption-of-genetically-engineered-crops-in-the-us.aspx#.VCzU_CldWyo

2, 3, 4 Center for Food Safety. Seed Giants vs. U.S. Farmers, February 13, 2013. www.centerforfoodsafety.org/reports/1770/seed-giants-vs-us-farmers#

GE cotton seeds cost farmers two to ten times more than non-GE varieties⁵ and, because of TUG requirements, had to be purchased each season, forcing many farmers to borrow money just to buy seed. Then, in order to secure the high yields these new, expensive seeds promised, farmers who traditionally relied on rainfall for irrigation borrowed more money for wells and irrigation equipment to provide the thirsty GE crops with a steady supply of irrigation water. GE seeds are genetically identical clones bred in closely monitored field trials under optimum conditions. As a result, they require optimum conditions to produce the increased yield they are advertised as capable of producing and that is necessary for farmers to be able to pay back the mounting debt from seed, pesticide, and irrigation purchases. In a year of poor rainfall or when a well pump fails, many farmers suddenly find themselves paralyzed by debt. In the years following India's adoption of GE cotton, farmers fell deeper and deeper into debt to recoup their investment in GE seeds, and scores of smallholder farmers eventually gave up trying. From 2002 and 2010, 153,727 farmers committed suicide in India.⁶

Many more farmers, in India and elsewhere, find themselves in a similar situation, heavily burdened by debt and pressured to cultivate more land just to make ends meet. In an effort to provide farmers with more options, organizations such as the Organic Seed Alliance and The Land Institute are researching and breeding organic seeds for commercial production and (in The Land Institute's case) for sustainable farming systems based on perennial crops. Unlike hybrid and GE seed, these are generally open-pollinated varieties that farmers can save from season to season. Still a minor source of seeds even for organic growers, more government-funded research is needed to develop commercially viable organic seeds for the wide variety of crops grown in the U.S. and abroad.

Although the debate about genetically engineered crops is likely to continue for the foreseeable future, it is important to recognize the serious impacts of this technology on the viability of farm communities around the world today. From public research to farmer sovereignty and suicides, the effect of corporate control and ownership of seed on a farmer's ability, and right, to save and replant seeds has far-reaching implications for the wellbeing of individuals and of agricultural communities.

5 Center for Human Rights and Global Justice, *Every Thirty Minutes: Farmer Suicides, Human Rights, and the Agrarian Crisis in India*; p.7 (New York: NYU School of Law, 2011). www.chrgj.org/publications/docs/every30min.pdf

6 Compiled from Crime Records Bureau, *Accidental Deaths and Suicides in India*, available at ncrb.nic.in/ (Scroll over "Publications", then click "Accidental Deaths & Suicides in India")

Appendix 1: Field-Scale Transplanting Guide

Crop	VERY EASY TO TRANSPLANT	MODERATELY EASY TO TRANSPLANT	CHALLENGING TO TRANSPLANT	ALMOST NEVER TRANSPLANTED	COMMENTS
Broccoli	X				slight stress in plant trays will result in premature flowering
Cabbage	X				
Cauliflower	X				
Chard	X				
Collards	X				
Kale	X				
Lettuce	X				
Tomatoes	X				OK to overharden / handles stress well
Celery		X			
Eggplant		X			
Leeks		X			
Onions (bulbing)		X			can be planted in "nursery bed" in field
Onions (bunching)		X			can be planted multiple seeds per cell
Peppers		X			
Beets*			X		
Cucumbers**			X		
Melons**			X		
Pumpkins**			X		
Radishes*			X		rapid seed emergence makes direct sowing desirable
Salad Mix*			X		
Spinach*			X		
Squash (Summer)**			X		
Squash (Winter)**			X		
Turnips			X		rapid seed emergence makes direct sowing desirable
Beans				X	
Carrots*				X	
Corn				X	
Peas				X	

* close spacings make transplanting uneconomical in most situations

** transplanting often results in reduced yield compared to direct sown

Appendix 2: Common Transplant Spacings: Common Seeding Rates & Thinning Distances

CROP	Transplant (TP) or Direct Sow (DS)	Spacing / Thin to	Notes for Central Coast CA
Arugula	DS	20-50 seeds/ft	Seeding rate depends on seeder type/seed plate
Basil	TP	8"	Plant out clusters from plug tray, 4-6 seeds/cell
Beans, bush	DS	thin to 3"	1.5# per 300' row, plant 2 beds at a time, = 3#/sowing
Beets	DS	thin to 3"	2 oz sows 300'; 4 oz per 2-line bed. Divide seed total between Red, Golden and Chioggia varieties.
Broccoli	TP	12"	
Brussels Sprouts	TP	16"	
Cabbage	TP	12"	
Carrots	DS	Thin to 2"	1 oz raw seed sows 600 feet
Cauliflower	TP	14"	
Celeriac	TP	8" -12"	
Celery	TP	8"	
Chard	TP	8-10"	Early and late season (break leaf miner cycle with summer gap)
Chinese Cabbage	TP	12"	Cover well with remay for flea beetles
Cilantro	DS	50 seeds/ft	1 oz sows 275 linear feet. Good beneficial habitat when flowering.
Collards	TP	12"	
Corn	DS	10-12"	
Cucumbers	DS or TP	12"-24"	
Dill	DS	thin to 3"	20,000 seeds/oz 1 oz plants 2500 linear feet
Fennel	TP	8"	
Garlic	DS	6"	
Greens, Asian: baby Bok Choy	DS	thin to 6-8"	1 oz seeds 830' (cover with remay)
Kale	TP	10"	Plant early and late. Aphid problems in spring – use Red Ursa.
Kohlrabi	TP	8"	
Leeks	TP	4-8"	
Lettuce, full size	TP	10"	
Lettuce, mini heads	TP	6"	
Onions, storage	DS	thin to 5"	1 oz plants 300
Onions, "Purplette" fresh bunching	TP	8"	Sow as clusters of 5 in TP trays
Onions, Cipollini	TP	8"	Plant in mid-April from transplant for harvest mid-July. Plant in clusters.
Pac Choi	TP	10"	
Parsley, Italian	TP	12"	

Appendix 2 (cont'd): Common Transplant Spacings: Common Seeding Rates & Thinning Distances

CROP	Transplant (TP) or Direct Sow (DS)	Spacing / Thin to	Notes for Central Coast CA
Peppers, Sweet	TP	12-18"	4 peppers = about 1.15#
Peppers, Hot	TP	12"	
Potatoes	DS	10-12"	
Radishes	DS	2"	
Salad Mix	DS or TP	TP: 4-6", DS:	
Spinach	DS	swath	
Squash, Summer	DS	Thin to 24"	Sow 1/ft and thin. Leave empty bed next to planted bed for ease of harvest/cultivation.
Squash, Winter & Pumpkins	DS	Thin to 24"	30-40" between row spacings for bush type squash, 6"-80" for vining types
Strawberries	buy plants	12"	Plant into plastic
Tomatoes, Dry Farm	TP	24-36"	Skip a row for less water competition
Tomatoes, Heirlooms	TP	24"	
Turnips, Tokyo type	DS	Thin to 3"	

Appendix 3: Transplanting & Irrigation Equipment

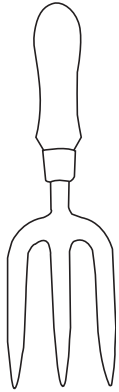

Hand Fork



Hand Trowel

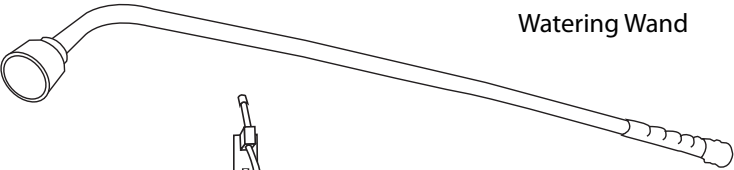

Watering Wand

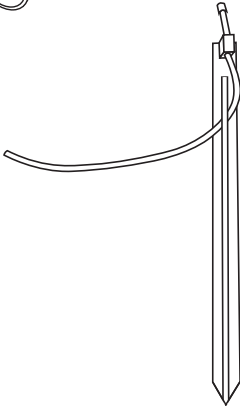

Micro-sprinkler

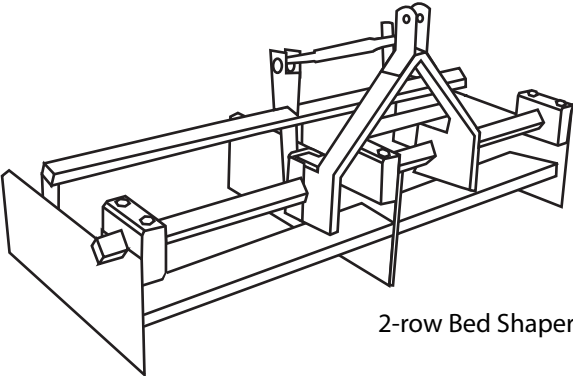

2-row Bed Shaper

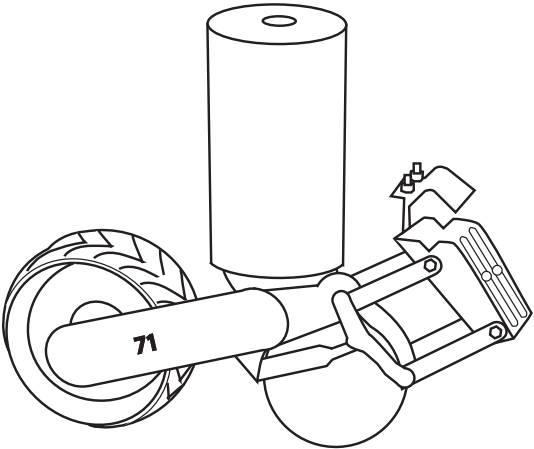

John Deere Model 71 Plate Planter

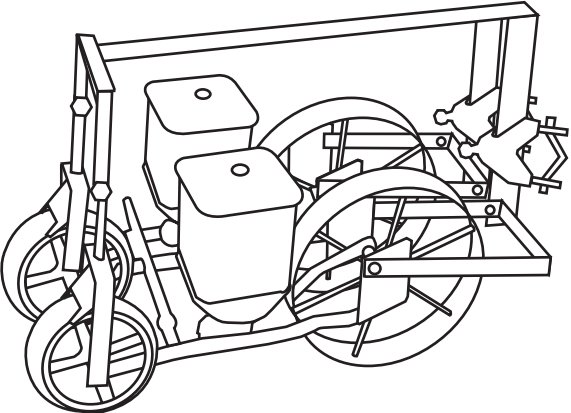

Planet Jr. Vegetable Planter

Illustrations by Cathy Genetti Reinhard; not to scale

Appendix 3 (cont'd): Transplanting & Irrigation Equipment

Dibble



Dibble for creating lines of holes for transplanting. Note that the shape of the dibble creates a hole that fits transplant "plugs."

String Jig

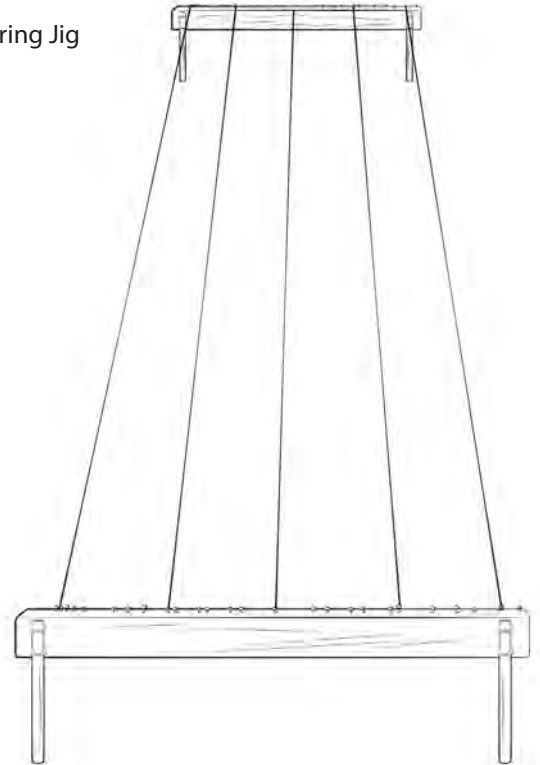

String jig used to delineate rows for direct seeding and transplanting. The jig has screws set at different widths; string is wrapped onto the head of the screws to mark different row spacings.

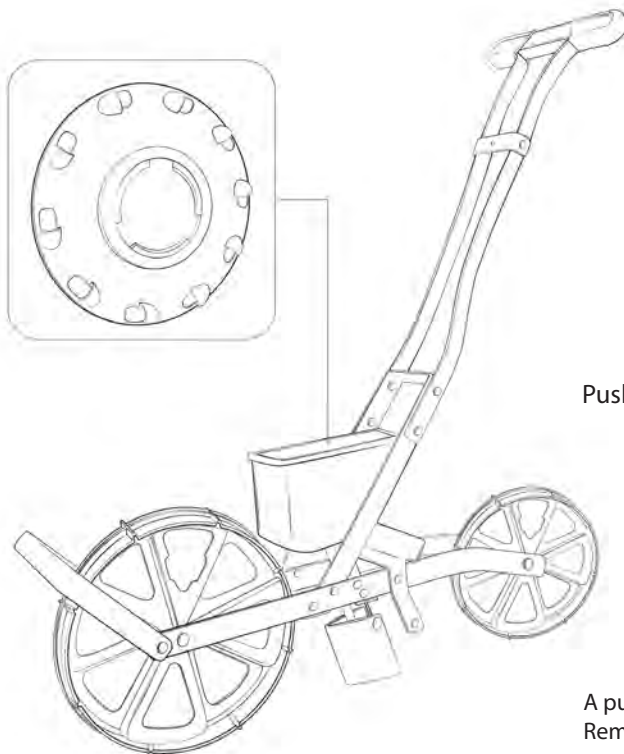

Push Seeder

A push seeder used to seed garden beds. Removeable plates are used for different seed sizes.

Illustrations by José Miguel Mayo

Appendix 4: Seedlings at Transplant Maturity: Planting Depth

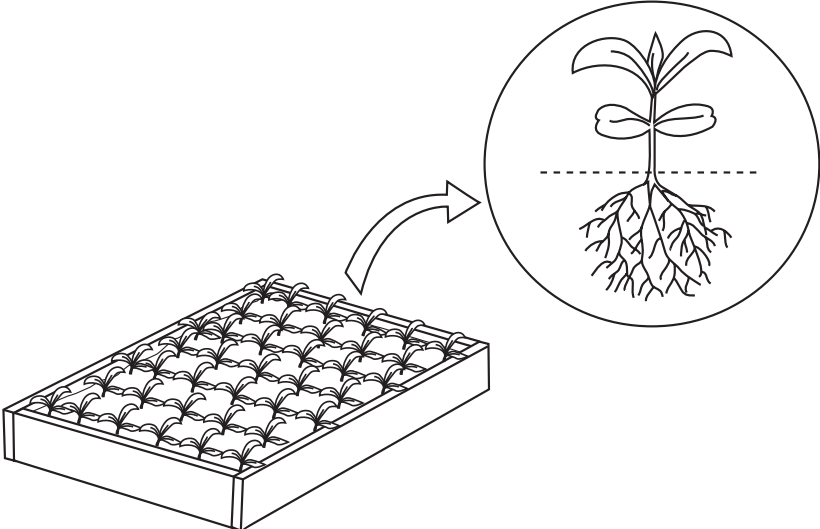

Flat-grown seedling at transplant maturity—
note balance of roots and shoots

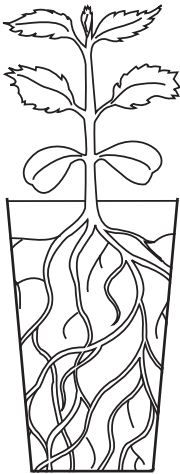

Cell-grown seedling at transplant maturity—
note balance of roots and shoots

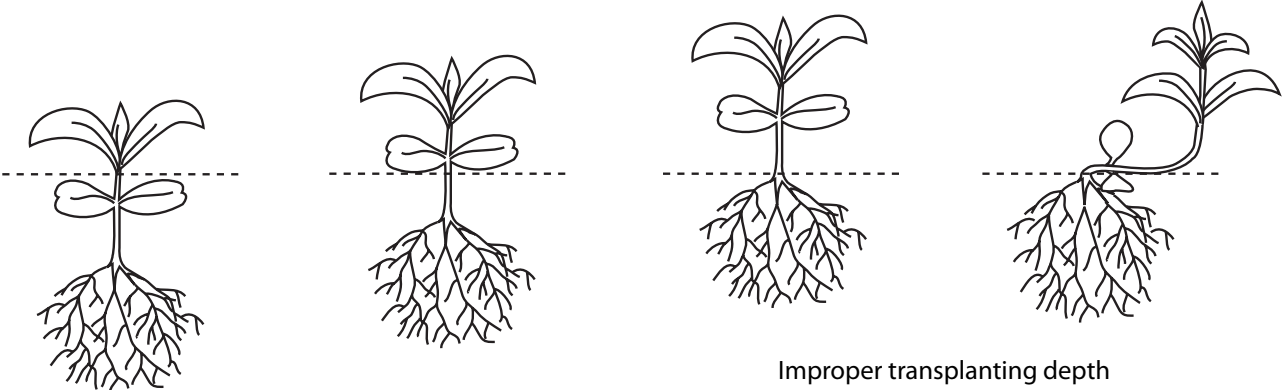

Proper transplanting depth

Improper transplanting depth

Illustrations by Cathy Genetti Reinhard; not to scale

Appendix 5: Estimating Soil Moisture by Feel

Note: For garden beds, soil moisture should be at 75%–80% field capacity prior to transplanting or direct seeding. In the field, soil should be at 50%–60% of field capacity prior to transplanting or direct seeding. See also the Planting to Moisture information in Supplement 1 of Unit 1.10, Managing Weeds.

SOIL MOISTURE LEVEL (% OF FIELD CAPACITY)	COARSE (SAND)	LIGHT (LOAMY SAND, SANDY LOAM)	MEDIUM (FINE, SANDY LOAM, SILT LOAM)	HEAVY (CLAY LOAM, CLAY)
0–25% No available soil moisture. Plants wilt.	Dry, loose, single grained, flows through fingers. No stain or smear on fingers.	Dry, loose, clods easily crushed and will flow through fingers. No stain or smear on fingers.	Crumbly, dry, powdery, will barely maintain shape. Clods, breaks down easily. May leave slight smear or stain when worked with hands or fingers.	Hard, firm baked, cracked. Usually too stiff or tough to work or ribbon ¹ by squeezing between thumb or forefinger. May leave slight smear or stain.
25–50% Moisture is available, but level is low	Appears dry; will not retain shape when squeezed in hand	Appears dry; may tend to make a cast ² when squeezed in hand, but seldom will hold together	May form a weak ball ² under pressure but will still be crumbly. Color is pale with no obvious moisture.	Pliable, forms a ball; will ribbon but usually breaks or is crumbly. May leave slight stain or smear.
50–75% Moisture is available. Level is moderate to high.	Color is darkened with obvious moisture. Soil may stick together in very weak cast or ball.	Color is darkened with obvious moisture. Soil forms weak ball or cast under pressure. Slight finger stain, but no ribbon when squeezed between thumb and forefinger.	Color is darkened from obvious moisture. Forms a ball. Works easily, clods are soft with mellow feel. Will stain finger and have slick feel when squeezed.	Color is darkened with obvious moisture. Forms good ball. Ribbons easily, has slick feel. Leaves stain on fingers.
75% to field capacity (100%) Soil moisture level following an irrigation	Appears and feels moist. Color is darkened. May form weak cast or ball. Will leave wet outline or slight smear on hand.	Appears and feels moist. Color is darkened. Forms cast or ball. Will not ribbon, but will show smear or stain and leave wet outline on hand.	Appears and feels moist. Color is darkened. Has a smooth, mellow feel. Forms ball and will ribbon when squeezed. Stains and smears. Leaves wet outline on hand.	Color is darkened. Appears moist; may feel sticky. Ribbons out easily, smears and stains hand, leaves wet outline. Forms good ball.

¹ Ribbon is formed by squeezing and working soil between thumb and forefinger

² Cast or ball is formed by squeezing soil in hand

See also:

USDA, Natural Resources Conservation Service. 1998. Estimating Soil Moisture by Feel and Appearance. Program Aid Number 1619. www.nrcs.usda.gov/wps/portal/nrcs/detail/mt/newsroom/?cid=nrcs144p2_056492

Appendix 6: Garden-Scale Seed Bed Irrigation

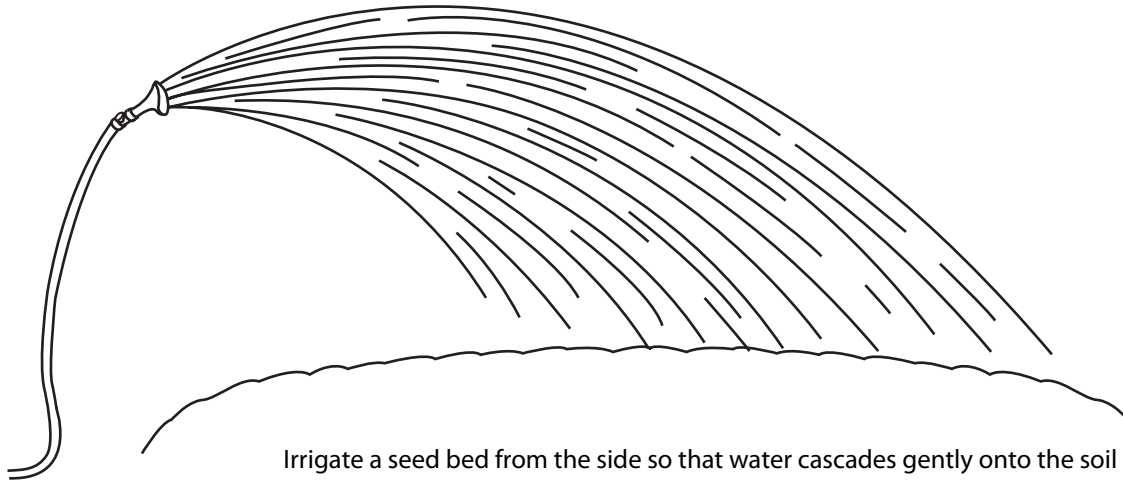

Irrigate a seed bed from the side so that water cascades gently onto the soil surface

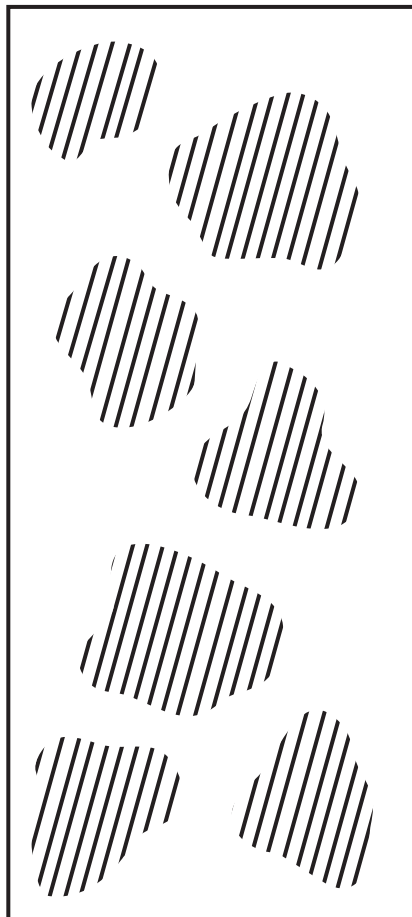

Irrigate a seed bed each time 50% of the bed's surface area has dried

Illustrations by Cathy Genetti Reinhard

Irrigation—Principles and Practices

Introduction	205
Lecture 1: Irrigation Concepts and Terminology	207
Lecture 2: Irrigation Scheduling and Delivery Systems	209
Demonstration 1: Field-Scale Irrigation	217
Demonstration 2: Garden-Scale Irrigation	219
Hands-On Exercises	221
Assessment Questions and Key	227
Resources	229
Supplements	
1. Evapotranspiration (ET) and the Factors that Affect ET Rates	233
2. Overview of “Water Budget Approach” for Efficient Irrigation Management	235
3. Soil Moisture Sensing Instruments Commonly Used for Irrigation Schedules	237
4. Overview of Dry Farming on the Central California Coast	239
5. Nitrate Contamination of Groundwater	243
Appendices	
1. Water Cycling Terms	245
2. Units of Water Measurement	247
3. Calculating Distribution Uniformity	248

4. Estimating Soil Moisture By Feel	250
5. Critical Periods for Soil Water Stress by Crop	252
6. General Irrigation Rules	253
7. Irrigation for Various Vegetable Crops	254
8. Soil Probe and Soil Auger	256
9. Irrigation System Components	257
10. Field Irrigation Schedule	259
11. Garden Irrigation Schedule	260
12. Amount of Water Needed to Pre-Irrigate a Dry Soil to Different Depths	261
13. Sample Sprinkler and Drip Tape Application Rate Calculations	262

Introduction: Irrigation

UNIT OVERVIEW

Effective irrigation practices can improve yields and quality, minimize water use, and protect natural resources. This unit introduces students to the basic concepts, tools, and skills used to deliver water efficiently and effectively on both a field and garden scale. Students will learn about the role of irrigation water in agriculture, the movement and cycling of water in agricultural systems, and the environmental factors that influence the type, frequency, and duration of irrigation.

Two lectures and two demonstrations introduce the resources and essential skills needed to determine the proper timing and volume of irrigation. The first lecture covers basic irrigation concepts and terminology. The second lecture addresses the use of both quantitative (water budget and soil moisture sensors) and qualitative (feel) approaches to determine irrigation timing, outlines environmental factors that influence irrigation decisions, and describes irrigation delivery systems. Through exercises and problem solving, students will practice calculating water budgets used to develop irrigation schedules and determine total water volume needs per unit of time. The latter calculations will help the student determine needed irrigation delivery systems. Supplements to the lectures offer additional information on using the water budget approach to manage irrigation efficiently, along with details on water sensor technologies, dry farming techniques, and health and environmental impacts of nitrates contamination.

MODES OF INSTRUCTION

- > LECTURES (2 LECTURES, 1 –1.5 HOURS)
 - Lecture 1 covers the role of irrigation water along with irrigation concepts and terminology. It finishes with a brief overview of differences and similarities between garden- and field-scale irrigation.
 - Lecture 2 focuses on techniques used to determining when to irrigate and how much water to apply. Note: If possible, have soil at different moisture levels available to demonstrate the “feel” approach to judging soil moisture.
- > DEMONSTRATION 1: FIELD-SCALE IRRIGATION (2 HOURS)
 - This field-scale demonstration illustrates how to gauge soil moisture by feel and how to establish, use, and maintain field-scale irrigation equipment.
- > DEMONSTRATION 2: GARDEN-SCALE IRRIGATION (2 HOURS)
 - This garden-scale demonstration illustrates how to gauge soil moisture by feel and how to establish, use, and maintain garden-scale irrigation equipment.
- > EXERCISES 1–3: FIELD- AND GARDEN-SCALE IRRIGATION SAMPLE CALCULATIONS (0.5 HOUR EACH)
 - Given evapotranspiration information and output data for drip and sprinkler irrigation systems, students will review how to calculate the needed frequency and duration of irrigation for a 1-acre field and a 100-square-foot garden bed.
- > EXERCISE 4: CALCULATING A WATER BUDGET FOR A ONE-ACRE BLOCK OF VEGETABLES (0.5 HOUR)
 - Students will use their region’s evapotranspiration information to calculate the needed frequency and duration of irrigation for a 1-acre field.
- > EXERCISES 5–6: HOW MUCH WATER DO I NEED? HOW MANY ACRES CAN I IRRIGATE? SAMPLE CALCULATIONS (0.5 HOUR EACH)
 - Students will practice calculating total water volume needs per unit of time to determine the need for irrigation infrastructure.
- > ASSESSMENT QUESTIONS (0.5 HOUR)
 - Assessment questions reinforce key unit concepts and skills.
- > POWERPOINT
 - See casfs.ucsc.edu/about/publications, and click on Teaching Organic Farming & Gardening.

LEARNING OBJECTIVES

CONCEPTS

- The role of irrigation water in agricultural systems
- The movement and cycling of water in agricultural systems: E.g., transpiration, capillary action, evaporation, evapotranspiration, evapotranspiration rate, percolation
- Water quantity measurements: E.g., acre/feet, acre/inch, one hundred cubic feet (CCF), gallons/minute (GPM)
- Relevant measurements of soil moisture: Soil saturation, gravitational water, field capacity, permanent wilting point
- Environmental factors that influence the type, frequency, and duration of irrigation
- Different way to determine the need for irrigation: qualitative (feel method) and quantitative (water budgeting, soil moisture sensors)

SKILLS

- How to determine the timing and volume of irrigation using qualitative approaches: Gauging relative measures of field capacity using the feel method
- How to determine the timing and volume of irrigation using quantitative approaches: Water budgeting calculations using evapotranspiration rates and calibrated water delivery systems
- How to calculate total water volume needs per unit of time to determine the need for irrigation infrastructure
- How to access web-based irrigation information
- How to determine the appropriate irrigation delivery system to use for specific crops and settings

Lecture 1: Irrigation—Concepts & Terminology

Pre-Assessment Questions:

1. Why is water important for growing crops?
2. How is water volume commonly measured in agricultural systems?
3. How does irrigation water cycle through an agricultural system?
4. How does water stress negatively affect crop development and yield?

A. The Role of Irrigation Water in Agriculture Systems

1. Sustains soil biological and chemical activity and mineralization during dry periods: In seasonally dry areas, irrigation water artificially extends the time period in which soil biological activity and nutrient release are elevated, creating more optimal growing conditions for cultivated crops
2. Promotes soil solution and nutrient uptake: Irrigation water becomes the medium into which soil nutrients are dissolved (soil solution) and through which nutrients are made available for plant uptake
3. Provides carbohydrate building block: $6 \text{ CO}_2 + 6 \text{ H}_2\text{O} \rightarrow \text{C}_6\text{H}_{12}\text{O}_6 + 6 \text{ O}_2$: Through the process of photosynthesis, water molecules taken up by plants are broken down and their constituent atoms rearranged to form new molecules: carbohydrates and oxygen
4. Provides plant structure/support: Water molecules contained within the water-conducting vascular bundles and other tissues of plants serve to provide physical support for the plant itself
5. Promotes the maintenance of optimal temperatures within the plant: The loss of water through the process of evapotranspiration (defined below) liberates heat from the plant, thereby regulating plant temperature
6. Protects crops from frost damage: Irrigation water is commonly used to lower the freezing temperature in orchard systems during threats of damaging frost
7. Reduces plant stress: By reducing stress on the plant, proper irrigation improves plants' resistance to pest and disease damage and improves crop quality (see E, below)

B. Water Cycling in Agricultural Systems

1. Definition of terms (see also Appendix 1, Water Cycling Terms)
 - a) Transpiration: Water transfer to the air through plant tissues.
 - b) Evaporation: The loss of water to the atmosphere from soil and plant surfaces
 - c) Evapotranspiration: The loss of water to the atmosphere by the combined processes of evaporation and transpiration (see more at Supplement 1, Evapotranspiration (ET) and the Factors that Affect ET Rates)
 - d) Capillary action: The movement of water through very small pores in the soil from wetter areas to drier areas. Water may move vertically and horizontally.
 - e) Infiltration: The process by which water on the ground surface enters the soil
 - f) Percolation: The gravitational process of water moving downward and through the soil horizons

C. Units of Water Measurement

1. Definition of terms
 - a) Acre inch: The equivalent volume of water application that would cover one acre of land one inch deep in water. Example: On average, approximately one inch of water is lost through evaporation and plant transpiration each week from May 15th–October 15 along the central coast of California (see Appendix 2, Units of Water Measurement)
 - b) Acre foot: The equivalent volume of water application that would cover one acre of land one foot deep in water
 - c) Gallons per minute (GPM): The number of gallons being delivered through an irrigation system in one minute
 - d) One hundred Cubic Feet (CCF): Term commonly used by municipal water providers as a means of water measurement based on volume. 1 CCF equals 748 gallons.
 - e) Pounds per square inch (PSI): Water pressure in irrigation systems is measured in PSI. Determining your irrigation system's specific PSI is important in irrigation planning.
 - f) Distribution Uniformity (DU): A measure of how uniformly water is applied to the area being irrigated, expressed as a percentage. The higher the DU percentage, the more uniform the application. See Appendix 3, Calculating Distribution Uniformity, for additional information.

D. Overview of Garden vs. Field-Scale Irrigation (to be further discussed in Lecture 2, Irrigation Scheduling and Delivery Systems)

1. Features of garden- and field-scale cropping systems that influence irrigation
 - a) Gardens: Smaller, more diverse, hand cultivated
 - b) Garden irrigation water sources
 - i. Domestic wells with 2 to 5 horsepower submersible pumps (10 gal/minute average output)
 - ii. Municipal water systems (for urban gardens)
 - c) Fields: Larger blocks of plantings, mechanically cultivated
 - d) Field irrigation water sources; note—minimum 10 gal/acre/minute recommended
 - i. Agricultural wells (10 horse power or larger electric or diesel pumps / 50 gallons per minute minimum)
 - ii. Surface sources supplemental to well water (ponds, creeks)
 - iii. Water district deliveries from surface sources supplied through canals or pipe lines
2. Similarities in irrigation scheduling and delivery systems between the two settings
 - a) Whether operating on a garden scale or field scale, irrigation managers need to make decisions about water application rates and type of delivery based on crop needs, weed management, disease potential, evapotranspiration (ET) rates, and harvest schedules while using both labor and water wisely and efficiently.
3. Differences in irrigation scheduling between the two settings
 - a) Garden scale: Typically use “soil moisture by feel” (qualitative) approach to determine need for irrigation, as well as scheduling and reference to local ET rates (see Lecture 2 and Appendix 4, Estimating Soil Moisture by Feel)
 - b) Field scale: Typically use water budgeting (quantitative) approach along with tensiometers or other moisture monitoring devices to determine need for irrigation (see more at Lecture 2, as well as Supplement 2, Overview of “Water Budget” Approach for Efficient Irrigation Management, and Supplement 3, Soil Moisture Sensing Instruments Commonly Used for Irrigation Schedules)

Lecture 2: Irrigation Scheduling & Delivery Systems

Pre-Assessment Questions:

1. How do you determine when it is time to irrigate?
2. What is the fundamental difference between a qualitative (by feel) and quantitative (water budget, soil moisture meter) approach to determining when to irrigate?
3. How do you determine how much water to apply?
4. What are some of the environmental factors that may influence the frequency or duration of irrigation?
5. What are some of the environmental factors that may influence the type of irrigation used?
6. What are some of the different irrigation delivery systems available?

A. Definitions of Terms Specific to Soil Moisture Assessment (see also illustrations in Appendix 1, Water Cycling Terms)

1. A number of terms are used when discussing the amount of moisture in the soil and plant's ability to access that moisture
 - a) Soil saturation: When all the pores of a given soil are filled with water. Soil rarely remains saturated once watering (rain or irrigation) stops because gravitational water percolates (drains) down to deeper soil strata.
 - b) Gravitational water: The water that will drain from a saturated soil if no additional water is added. This water is not available for plant growth.
 - c) 100% of field capacity: The point reached when no additional gravitational water drains from a previously saturated soil. At 100% field capacity the largest pores of the soil structure (macropores) have been drained of water and replaced with air, while micropores still retain water. This water is available to plants, which have the ability to move water against gravity due to the upward pulling force produced by transpiration. At field capacity, an improved soil retains the maximum amount of water available to plants, as well as optimal air space for aerobic microbial activity and plant growth.
 - d) 50% of field capacity: The amount of water remaining in the soil when 1/2 of the water held in the soil at field capacity has evaporated, drained, and/or has been transpired by growing plants; 50%–60% of field capacity in the root zone of the crop is the soil moisture level at which most crops should be irrigated
 - e) Permanent wilting point (PWP): The point at which soil moisture has been reduced to where the plant cannot absorb it fast enough to grow or stay alive
 - f) Plant available water (PAW): The water content held in the soil between field capacity and permanent wilting point that is available for uptake by plants
 - g) Soil water potential: The amount of energy required to remove water from the soil. This measurement increases as soils dry, which then increases the possibility of transpiration rates exceeding the rate of uptake, leading to plant stress.
 - h) Management allowable depletion (MAD): Maximum amount of soil water the irrigation manager allows the crop to extract from the active rooting zone between irrigations. This amount can vary with crop, stage of growth, potential for rainfall, and the soil's water holding capacity.

B. Soil Moisture, Plant Stress, and Crop Productivity

1. Yield may be reduced due to water stress
 - a) Water-stress-sensitive stages of crop development (prioritized); see also Appendix 5, Critical Periods for Soil Water Stress by Crop
 - i. Flowering
 - ii. Yield formation/fruit set
 - iii. Early vegetative growth/seedling stage
 - iv. Fruit ripening
2. General signs of water stress

Plants can show some water stress and still recover—however, extreme lack of water will cause permanent wilting (see below) and death. Signs of water stress include:

 - a) Graying leaves: A change in leaf color from a vibrant green to a dull gray-green or bluish color
 - b) Loss of sheen: Plant leaves change from glossy to dull in appearance
 - c) Insect damage: The presence of cabbage aphids on Brassica family crops (broccoli, cabbage, kohlrabi, etc.) often indicates dry conditions
 - d) Damage to the root system: Upon closer examination, plants that look dry even after watering often have root damage, e.g., from symphylans, and can't take up sufficient water
 - e) Red or purple leaf color: Can indicate dry conditions, saturated conditions (anaerobic), or root damage
 - f) Development of small spines on the leaf margins or increased spinyiness on stems: This condition is especially likely to occur in lettuce and related species such as endive that experience water stress
 - g) Wilting: Pay attention to the time of the day. If plants wilt early in the cool of the day, this can be a sign that they need water. Some wilting in the mid-day heat (e.g., zucchini, winter squash) is a plant-protective strategy to reduce transpiration losses.
 - h) Slower than expected growth: This can be detected over time with a practiced eye
3. Water stress increases crops' susceptibility to pests and pathogens

Crops repeatedly subjected to water stress will be less resistant to both pest and pathogens
4. Permanent wilting point

Permanent wilting point is defined as the point at which soil moisture is too low for the plant to take up water against the pull of gravity. Crop plants reaching permanent wilting point often do not grow well thereafter, are non-productive, or die.

C. Factors Influencing Frequency and Volume of Irrigation

A number of factors, from climate and soil type to stage of crop maturity, must be considered in determining when and how much to irrigate. Factors include:

1. Climate
 - a) Air temperature: Increased air temperatures will increase the rate of evapotranspiration (ET)
 - b) Precipitation: In areas of regular summer rainfall, where precipitation exceeds ET, irrigation is seldom required. Irrigation demands are based on ET rates. Where ET exceeds precipitation, irrigation is required.
 - c) Humidity: Increased humidity will decrease the rate of ET
 - d) Wind: High wind speeds increase ET

2. Soils

- a) Sandy soils drain rapidly and do not hold water well
- b) Silty soils drain slowly and hold water well
- c) Clay soils drain very slowly and hold water tightly
- d) Loam soils both drain well and hold water well
- e) Agricultural soils improved with organic matter (cover crops, compost) maintain good drainage and moisture retention properties (for more on this topic, see discussion in Unit 1.6, Selecting and Using Cover Crops and Unit 1.7, Making and Using Compost)

3. Stage of development and crop natural history

- a) “Water-loving” crops (e.g., celery) demand less fluctuation in soil moisture levels (see Appendix 6, General Irrigation Rules, and Appendix 7, Irrigation for Various Vegetable Crops)
- b) Drought-tolerant crops (e.g., tomato varieties, winter squash varieties, Amaranth, etc.) may require little or no irrigation (see Supplement 4, Overview of Dry Farming on the Central California Coast)
- c) Maturation period: Prior to harvest, many crops (e.g., onions and garlic) require a gradual reduction in irrigation to encourage maturation
- d) The specific watering needs of tree fruits are highly variable, and depend on a combination of the tree’s age and size, rootstock, and your soil and climate. In general, deciduous fruit trees need readily available moisture in the root zone through harvest to promote canopy development, extension growth, fruit sizing, and fruit maturation. This normally means letting the soil dry down to no more than 6–8” deep between irrigations and replacing water based on local ET rates to ensure high fruit quality.
- e) Citrus and other evergreen fruit trees also need regular water delivery for the same reasons noted above for deciduous fruit. In the case of citrus, which are often flowering, setting fruit, and maturing fruit simultaneously, consistent water delivery is important to maintain citrus tree health, vegetative vigor, and fruit quality. Both irrigation and rainfall should be monitored year round, and the soil should only be allowed to dry to a depth of 3–4”, followed by an irrigation set to replace water lost to ET. Underwatering citrus as fruit ripens can lead to small fruit and dry, flaky interiors.
- f) Vase life of cut flowers can be improved—in some cases dramatically—by developing an irrigation schedule that delivers water to crops ready to harvest at least 12 hours but not more than 24 hours prior to harvest. This will help ensure that stems have full turgor and stress can be minimized, allowing stems to maintain turgor through post-harvest uptake rather than trying to compensate for an already extant water deficit. With reduced stress, plants will consume stored nutrients more slowly, extending the time that cut stems remain strong and vibrant.

D. Determining When to Irrigate and How Much Water to Apply

1. Measuring soil moisture by feel: A qualitative approach

- a) Measuring soil moisture by feel includes learning how to judge soil moisture by forming soil into a cast or ball, and by “ribboning” soil (see Appendix 4 and the NRCS publication *Estimating Soil Moisture by Feel and Appearance* noted in the Resources). This takes practice! Knowing the percent of soil moisture present can help determine whether irrigation is needed.
- b) Shovels, trowels, and soil augers can be used to obtain soil samples to a depth of up to 12 inches in the crop root zone for accurate moisture assessment (see illustrations in Appendix 8, Soil Auger and Soil Probe)

2. Considerations for determining irrigation scheduling using the “feel” approach
 - a) The “feel” method is more commonly used by irrigation managers in garden and small farm systems as a low-tech, low-cost way to assess irrigation needs in diverse cropping systems
 - b) Irrigation managers must be familiar with soil type and appropriate methods of soil moisture assessment to make accurate irrigation scheduling decisions
 - c) The “feel” approach to irrigation management requires a high level of intuition and experience, and an extensive knowledge of the specific requirements of the various crops being irrigated. Once understood, it can be a quick decision-making tool.
 - d) In deciding when and how much to irrigate, the irrigation manager must take into account a variety of factors in addition to soil moisture, including crop needs, and timing of harvest (see D. Factors Influencing Frequency and Volume of Irrigation, and below), as well as weed management operations to determine an optimum application time and rate
3. Determining irrigation scheduling using the water budget approach
 - a) Water budgeting is often compared to managing a savings account: The starting point is field capacity (see definitions, above), and as water is removed and the “savings balance” drops, it is replaced as needed by the crop. Water budgeting is a quantitative approach using existing models that analyze temperature and crop water use to determine evapotranspiration (ET) rates. Growers use these models to determine irrigation timing and amounts.
 - b) When seasonal ET exceeds precipitation, irrigation is required to sustain planted crops
 - c) Resources for determining regional average ET (e.g., CIMIS; see Resources section); you can use this regional average when determining a water budget
 - d) Replacing estimated water loss through ET with calibrated irrigation systems
 - i. Once the ET rate of your site is determined, this estimated volume of water may be replaced through the use of calibrated irrigation systems that deliver water at a known rate and volume. The Hands-on Exercises in this unit offer examples of how to calculate the irrigation time and frequency required to replace water with a calibrated irrigation system.
 - e) Irrigation scheduling in different systems based on water budgeting approach
 - i. Once the evapotranspiration rate for a crop in full canopy (in gallons/week) and the water delivery rates (in gallons/hour) of the irrigation system are estimated, the amount of time required to replace water lost may be calculated (see Hands-On Exercises). This calculation will provide the total number of hours required to replace the water lost through evapotranspiration. (An additional 10% should be calculated in to compensate for delivery system inefficiencies.)
 - ii. The frequency of irrigation should correspond to the time period required for the soil in the root zone of the crop to dry to approximately 50% of field capacity. Due to shallow root systems and greater susceptibility to water stress, annual crop culture often requires a higher frequency of irrigation (2–3 times/week for many crops).
 - iii. Established orchards, which have deep root systems and are less susceptible to water stress, often require less frequent but larger volumes of water to be delivered in each irrigation. In both situations the estimated amount of water lost through ET is replaced as needed to maintain the health of the crop.

- f) Once a decision is made to irrigate, and a volume is determined, the timing of the water application must take into account timing of future harvest and weed management operations
 - g) Disadvantages: Water budget approach is not easy to apply to small, diverse systems
 - h) Advantages: Water budget approach can be an effective tool to increase water use efficiency
4. Determining irrigation scheduling using tensiometers and other soil moisture sensors (see Supplement 3, Soil Moisture Sensing Instruments Commonly Used for Irrigation Schedules)
- a) As the cost of simple soil moisture sensors drops, many growers are beginning to incorporate these instruments in their systems to monitor soil moisture levels. Such devices provide site-specific data points that may be more accurate than CIMIS data and can be used in combination with other techniques to inform irrigation decisions.
 - i. Soil tensiometers and Electrical Resistance Sensing Devices (ERSDs) are the instruments most commonly used to measure soil moisture on California's Central Coast farms. Both must be carefully installed directly in the wetted area of the crop's root zone at a number of sites throughout the field for accurate monitoring (see Supplement 3 for details).
 - ii. Soil moisture sensors are often used in pairs at different depths, e.g., at 6 and 12 inches deep, to provide the irrigator with information on below-ground moisture dynamics
 - iii. Tensiometers and ERSDs provide soil/water tension readings that can be used to establish irrigation schedules adequate to maintain soil moisture at levels conducive to good crop growth and productivity
5. Other factors to consider when determining whether irrigation is needed
- a) How do the plants look? See above for list of general signs of water stress.
 - b) Weather patterns: E.g., a crop may look stressed at midday, but knowing that the weather will cool overnight and be foggy in the morning may mean that irrigation is not immediately required. Therefore observing the crops throughout the day is important.
 - c) After a cool period, the first hot day may trigger plants to look stressed, but in fact they may not need irrigation
 - d) Soil type: Soil type and organic matter levels will determine in part how the soil holds water (see the NRCS reference *Estimating Soil Moisture by Feel and Appearance* in References)
 - e) Type of crop: Different crops, different needs (Appendix 7, Irrigation for Various Vegetable Crops)
 - f) Stage of development: Some crops benefit from being slightly water stressed early in their growth cycle (e.g., tomatoes, beans, cucumbers and other cucurbits), or do not need irrigation once the plants begin to die back (e.g., potatoes). Others, particularly small-seeded crops such as lettuce and carrots, require that soils be kept moist in order to germinate effectively.
 - g) Optimal moisture for harvest: It is critical to maintain full turgor for leafy crops and cut flowers, particularly if they will not immediately go into a cooler or receive some form of hydrocooling, as is done with brassicas and similar crops (see more at C. Factors Influencing Frequency and Volume of Irrigation, above)

E. Problems with Overapplying Water

1. In many areas, fresh water is a limited resource. Irrigation practices that optimize the available supply are critical.
2. The energy and environmental costs involved in transferring water and "lifting" it to irrigation systems via pumps, etc., can be significant

3. Over application of irrigation water has the potential to germinate weed seeds that would have otherwise remained dormant in the soil, leading to higher labor costs for weed removal and/or significant crop competition resulting in decreased yields
4. Overapplying water can lead to unnecessary nutrient leaching, soil compaction, decreased water infiltration rates, erosion, and nutrient leaching (see Supplement 5, Nitrate Contamination of Groundwater)

F. Irrigation Delivery Systems (see also Appendix 9, Irrigation System Components)

1. Sprinklers
 - a) Micro sprinklers
 - i. Micro sprinklers are commonly used in small-scale orchards and vineyards
 - ii. Micro sprinklers are commonly used in garden-scale production systems that require frequent, light irrigation to help germinate small seeds
 - iii. Micro sprinklers provide uniform application of water and the relatively small droplet size minimizes soil surface crusting and aggregate dispersion
 - iv. Small droplet size is not optimal for distribution uniformity (DU) or water use efficiency in windy areas
 - b) Hand-moved aluminum pipe with impact or rotator type heads
 - i. Hand moved aluminum irrigation pipe is the most commonly used sprinkler irrigation delivery system in both small- and large-scale farming operations due to relatively low cost, long life, ease of use, and durability
 - ii. Hand moved aluminum pipes typically use 3-inch diameter lateral lines with a 3-gallon-per-minute (GPM) sprinkler head mounted on an 18" riser on each 30' long section of pipe. Lateral lines are typically spaced either 30' or 40' feet apart.
 - iii. Aluminum sprinkler pipes fitted with impact heads typically require an operating pressure of at least 45 psi for optimum uniformity. Rotator type heads require higher pressure.
 - c) Hand-moved PVC "riser system" for garden-scale applications
 - i. A simple-to-build, portable riser system of PVC and micro sprinklers can serve the same purpose as hand-moved aluminum pipe at a garden scale (see Appendix 9)
 - ii. Because it has fixed spray patterns of 180° and 360° at a pre-determined distance, the riser system can be sized to suit your garden's scale and design, assuming basic irrigation knowledge and access to a standard irrigation supply store
 - iii. The pattern and uniformity of distribution are relatively consistent and predictable, and the system can be run with minimal attention to water pressure
 - iv. Spray distribution, while still gentle on surface soil structure, is delivered in relatively large drops and risers are only 15"–18" tall, so loss of uniformity and evaporation due to wind exposure is minimized
 - v. The riser system can be used to germinate seeds, to grow overhead irrigation-loving or tolerant crops and low-growing crops to maturity, and can be used to pre-irrigate and flush weeds in smaller areas. In the absence of timely rains, the riser system can also be used to establish cover crops and until cover crop height exceeds the height of the risers.
 - d) Oscillators
 - i. Oscillating sprinklers are often used in garden settings, and are a relatively low-cost, easy-to-use water delivery system
 - ii. Advantages of oscillators
 - Offer large degree of coverage size and pattern flexibility in a single unit

- Relatively low cost, readily available, and can be operated with little technical background
- Although vulnerable to the wind, oscillators may be useful when “rough irrigating” large blocks of garden beds, e.g., prior to planting cover crops, and when irrigating large garden spaces

iii. Drawbacks

- Relatively low uniformity of water distribution and high rates of evaporation, especially in hot and/or windy situations (see below for more on distribution uniformity, or DU)
- Can take time to adjust and “dial in” to provide full, even coverage of the desired area without also delivering water beyond the boundary of the desired irrigation set
- Inconsistent distribution pattern and vulnerability to wind redistribution; neighboring crops may be subject to “drift” and thus increased disease incidence if they are prone to fungal disease of the leaf canopy
- Can be difficult or time consuming to accurately determine output/distribution, thus leading to over- or underwatering. For example, the adjustability of oscillators means the same device could water a 4' x 12' section or a 30' x 30' section. So an irrigation set of the same duration will deliver very different amounts to these two garden plots.
- Quality of oscillator brands—their useful lifespan, adjustability, and distribution uniformity—varies widely, and it can be difficult to know quality until you've invested considerable time and energy

2. Drip irrigation

- a) Drip irrigation has many advantages over sprinkler or flood irrigation, including application uniformity, the ability to apply water exactly where it is needed, and the potential reduction of disease and weed incidence in irrigated systems
- b) Drip irrigation refers to both rigid ½ inch poly tubing with inline emitters and the thin wall tubing commonly referred to as “drip tape.” Drip tape is available in an assortment of wall thicknesses and emitter spacings and is relatively low cost, but also much less durable compared to the rigid poly tubing.
- c) Drip tape is commonly used in small-scale vegetable production systems as a means of conserving water and minimizing weed and disease pressure
- d) Depending on the water source, drip tape and tubing often require filtration to limit clogging of emitters
- e) Drip tape and poly tubing with inline emitters require pressure regulation to optimize application uniformity
- f) Drip tape and poly tubing with inline emitters require a grade of 2% or less and runs of no more than 300 feet for optimum distribution uniformity
- g) Careful consideration must be given to design when setting up a drip irrigation system to optimize distribution uniformity and system function

G. Environmental Factors Influencing the Type of Irrigation Used

1. Climate and incidence of plant pathogens (see also Unit 1.9, Managing Plant Pathogens)
 - a) Overhead irrigation may encourage the growth and spread of certain plant pathogens on crops in certain climates (e.g., *Phytophthora* spp. on melons, cucumber, peppers, and tomatoes along coastal California).

H. Importance of Distribution Uniformity (DU)

1. Distribution Uniformity (DU) refers to how uniformly water is made available to plants over an area via an overhead sprinkler or drip irrigation system
2. DU can be measured using a simple “catch bucket” test and the “low quarter DU” calculation for both overhead and sprinkler irrigation systems (see Appendix 3 for details). Note that measuring DU of oscillating sprinklers may require more catch buckets to accurately measure uniformity throughout the coverage area (corners, edges, and middles of beds).
3. It is important to maintain high DU in order to optimize water use and ensure that the entire crop is receiving the intended amount of irrigation

Demonstration 1: Field-Scale Irrigation

for the instructor

INTRODUCTION

This demonstration offers students an in-field look at the tools and techniques used to deliver irrigation water efficiently from the mainline irrigation infrastructure through the specific irrigation delivery system used on your farm. The instructor should begin with an explanation of the irrigation infrastructure used to deliver water to and through the farm, then explain how to set up, adjust, and maintain the specific irrigation system(s) currently in use.

PREPARATION AND MATERIALS

- Map of farm irrigation system

Irrigation equipment:

- Established set of aluminum pipe with sprinklers
- Component pieces of sprinklers
- Established set of drip irrigation
- Component pieces of drip irrigation equipment
- Tools for setting up and adjusting irrigation equipment
- Irrigation schedules (see Appendix 10, Field Irrigation Schedule)

PREPARATION TIME

1.5 hours

DEMONSTRATION TIME

2 hours

DEMONSTRATION OUTLINE

A. Irrigation Infrastructure

1. Explain the layout and identify major components of the farm irrigation water delivery system from source to crop

B. Measuring Flow Rate

1. Demonstrate how to determine flow rate using a garden hose and a 5-gallon bucket

C. Sprinkler Irrigation Systems

1. Demonstrate a typical field layout and a typical orchard layout of a hand-moved aluminum sprinkler system. Include the following demonstrations:
 - a) The proper technique for moving and laying out sprinkler pipes
 - b) Flushing the system clean
 - c) Sprinkler head adjustment
 - d) Layout design and pipe hook-up
2. Demonstrate and explain the importance of proper head adjustment and timing as it relates to application uniformity

3. Demonstrate and explain how to determine optimum operating pressure
4. Students are given the opportunity to unhook, move, and hook up a sprinkler set. The sprinkler set is then turned on and adjusted.

D. Drip Irrigation Systems

1. Demonstrate and explain several examples of drip irrigation header set-ups
2. Demonstrate and explain how to turn on a drip system and set pressure and check for leaks
3. Demonstrate the following:
 - a) How a gate-valve and ball-valve work
 - b) How to set up a drip irrigation header
 - i. How to properly punch holes in the 2” oval tube
 - ii. How to install the barbed connectors into the oval tube
 - iii. How to connect the T-tape to the various types of connectors
 - iv. How to splice T-tape for repairs
 - v. How to cap ends of T-tape
 - vi. How to determine proper system pressure
 - vii. How to properly roll out and roll up T-tape for placement and storage
4. Have students cut and splice T-tape

E. Review and Discuss Irrigation Scheduling

1. Review the calculations in Hands-on Exercises 1–3 to determine the volume of water and the frequency of irrigation necessary to replace the water lost through regional evapotranspiration
2. Assign Exercise 4: Calculating irrigation requirements using regional evapotranspiration data
3. Describe and demonstrate the use of an irrigation schedule for tracking and planning irrigation (see Appendix 10)

F. Review and Discuss Exercises 5 and 6

1. Exercise 5: How much water is needed to irrigate a given area of land?
2. Exercise 6: How much area can one irrigate with a given flow rate?

G. Discuss water delivery systems needed to deliver the volumes of water given in Exercises 5 and 6

Demonstration 2: Garden-Scale Irrigation

for the instructor

OVERVIEW

Students must be able to accurately gauge soil moisture and use scale-appropriate irrigation tools and techniques in order to irrigate garden crops efficiently and effectively. The following demonstration provides an overview of the basic skills, concepts, and tools used in garden-scale irrigation. During this demonstration, the instructor should discuss the different approaches to irrigation (qualitative and quantitative) as well as demonstrate the tools and techniques used to monitor soil moisture and schedule irrigation.

PREPARATION AND MATERIALS

- Drip irrigation system
- Oscillators
- Fan
- Rose
- Micro sprinklers
- Garden riser
- Rain gauge
- Ross
- Soil moisture chart (see Appendix 4, Estimating Soil Moisture by Feel)
- Blank irrigation schedule (see Appendix 11, Garden Irrigation Schedule)
- Soil samples or pre-irrigated soils at varying percentages of field capacity

PREPARATION TIME

1.5 hours

DEMONSTRATION TIME

2 hours

DEMONSTRATION OUTLINE

A. Irrigation Management by Percent Field Capacity

1. Review terms
 - a) Soil saturation
 - b) Gravitational water
 - c) 100% of field capacity
 - d) 50% of field capacity
 - i. Review 50% of field capacity as critical moisture level for most cultivated annual crops
 - e) 25% of field capacity
 - f) Permanent wilting point
2. Review exceptions to the to the 50% field capacity general rule (see Appendix 6, General Irrigation Rules)
3. Review the stages of crop development at which plants are most sensitive to drought/ water stress (listed from most to least sensitive; see also Appendix 5, Critical Periods for Soil Water Stress by Crop)
 - a) Flowering
 - b) Yield formation/fruit set
 - c) Early vegetative growth/seedling stage
 - d) Fruit ripening
4. Have students gauge soil moisture (in percent field capacity) by feel and appearance using Appendix 4, and the USDA publication *Estimatng Soil Moisture by Feel and Appearance* (see Resources)
5. Review how to develop an irrigation schedule based on an estimated frequency of dry down to 50% of field capacity (see Appendices 11 and 12, Amount of Water Needed to Pre-Irrigate a Dry Soil to Different Depths)
6. Discuss and demonstrate how to properly maintain seedbed soil moisture for small- and large-seeded direct-sown crops
7. Discuss and demonstrate how to assemble, use, and repair garden-scale irrigation equipment (T-tape, oscillators, micro sprinklers, garden riser, etc.) in delivering water effectively and efficiently
8. Discuss and demonstrate how to assemble and repair the PVC portions of a garden-scale irrigation system

B. Irrigation Management Using the Water Budgeting Approach

1. Estimating crop Evapotranspiration (ET) loss from a crop in full canopy
 - a) The use of California Irrigation Management Information Systems (CIMIS) data to determine average weekly ET (see Resources section)
2. Review and discuss the calculations used in developing a weekly irrigation schedule to replace water lost through estimated ET for drip-irrigated crops. Assign and review the Garden Irrigation Exercise (see next section).
3. Discuss and demonstrate the use of rain gauges in monitoring the volumes of water delivered to replace water losses through ET in overhead-irrigated crops. Note the issue and challenge of achieving an adequate level of distribution uniformity in using oscillators, and the importance of identifying areas (middle, ends, and corners of beds) that may be receiving too much or too little irrigation.

Hands-On Exercises 1–3: Sample Calculations— Replacing Water Lost through Evapotranspiration (ET) Using the Water Budgeting Approach

for the student

In Hands-on Exercises 1 through 3, you will see sample calculations for the amount of irrigation time and frequency of irrigations required to replace water lost through evapotranspiration (ET) from a 1-acre block of vegetables using drip irrigation and sprinkler irrigation, as well as a 100-square-foot garden bed (respectively).

EXERCISE 1

The following sample calculation will show you how to calculate the amount of irrigation time and frequency of irrigations required to replace the amount of water lost through evapotranspiration from a 1-acre block of vegetables in full canopy using drip irrigation.

A. NUMBER OF GALLONS LOST THROUGH EVAPOTRANSPIRATION (ET) IN A 1-ACRE FIELD

- Daily average summer evapotranspiration rate (ET) for an actively growing crop in full canopy in Santa Cruz = 0.15 inch/day
- Multiply this by 7 days/week = 1.05 inches/week
- There are 27,158 gallons of water in an acre inch (the volume of water needed to cover an acre of land to a 1-inch depth)
- An acre = 43,560 square feet (roughly 208 feet x 208 feet)
- Multiplying 1.05 inches/week (ET) x 27,158 gallons/acre inch = 28,516 gallons/acre of water lost each week through evapotranspiration in an actively growing crop in full canopy in Santa Cruz, California

B. DRIP IRRIGATION OUTPUT CALCULATIONS

- Flow rate of high flow T-tape drip irrigation ribbon with 8-inch emitter spacing at 10 pounds per square inch (psi) = .74 gallons/minute/100 feet
- There are 14,520 feet of row per acre when beds are spaced 36 inches center-to-center
- To determine gallons/hour/acre emitted from one acre of drip irrigation ribbon, divide 14,520 (the number of row feet/acre) by 100 = 145 (the number of 100-foot lengths of drip irrigation ribbon in 1 acre). Multiply 145 by .74 gallons/minute/100 feet (the amount of water delivered through each 100 feet of ribbon) = 107.4 gallons/minute/acre.
- 107.4 gallons/minute x 60 minutes = 6,446 gallons/hour/acre. Two lines of drip tape would provide twice this volume, or 12,892 gallons/hour/acre.

C. CALCULATING IRRIGATION REQUIREMENTS

- 28,516 gallons/acre are lost through evapotranspiration each week from an actively growing crop in full canopy. The drip system described above is capable of delivering 6,450 gallons/hour/acre @ 10 psi. To calculate the amount of irrigation time required to replace the amount of water lost through ET complete the following:
 - Divide 28,516 gallons/acre (ET) by 6,450 gal/hour/acre (irrigation system application rate) = 4.4 hours of irrigation time required each week. Running the one acre of single line drip irrigation with 8 inch emitter spacing for 4.4 hours each week will apply 28,516 gallons/acre (~1.05 inches/acre), which is the amount of water needed to replace what is lost through ET. This total of 4.4 hours/week should be divided into 2–3 evenly timed irrigation sets.

EXERCISE 2

The following sample calculation will show you how to calculate the amount of irrigation time and frequency of irrigations required to replace the amount of water lost through evapotranspiration from a 1-acre block of vegetables using sprinkler irrigation.

A. NUMBER OF GALLONS LOST THROUGH EVAPOTRANSPIRATION (ET) IN A 1-ACRE FIELD

- Daily average summer evapotranspiration rate (ET) for an actively growing crop in full canopy in Santa Cruz = .15 inch/day
- Multiply this by 7 days/week = ~1.05 inches/week
- There are 27,158 gallons of water in an acre inch (an acre inch is the amount of water needed to cover an acre to a 1-inch depth)
- An acre = 43,560 square feet (roughly 208 feet x 208 feet)
- Multiplying 1.05 inches/week (ET) x 27,158 gallons/acre inch = 28,516 gallons/acre of water lost each week through evapotranspiration in an actively growing crop in full canopy in Santa Cruz, California.

B. SPRINKLER IRRIGATION OUTPUT CALCULATIONS

- Flow rate from a 1/8 inch nozzle running at an operating pressure of 45 psi is about 3 gallons per minute (gpm)

- There are roughly 109 sprinkler heads per acre using 20-foot pipes set 20 feet apart (20 feet x 20 feet = 400 square feet. 43,560 square feet/acre divided by 400 = 109)
- 109 sprinkler heads x 3 gpm each = 330 gallons per minute
- 330 gal/min x 60 minutes/hour = 19,800 gallons/hour/acre

C. CALCULATING IRRIGATION REQUIREMENTS:

- 28,516 gallons/acre are lost through evapotranspiration each week from an actively growing crop in full canopy. The sprinkler system is capable of delivering 19,800 gallons/hour/acre @ 45psi. To calculate the amount of irrigation time required to replace the amount of water lost through ET complete the following:
 - Divide 28,516 gallons/acre (ET) by 19,800 gallons/hour/acre (irrigation system application rate) = 1.4 hours of irrigation time required each week.
 - Running the one acre sprinkler system for 1.4 hours each week will apply 28,516 gallons/acre (~1.05 inches/acre), which is the amount of water needed to replace that lost through ET. This total of 1.4 hours/week should be divided in to 2–3 evenly timed irrigation sets/ week of 40 or 30 minutes respectively.

*Note: It is also important to factor in an additional 10–20% for evaporative loss due to extreme heat and wind conditions. It is further advisable to use several rain gauges to check the actual amount applied and to assess uniformity of applications. See Appendix 2: Calculating Sprinkler and Drip Distribution Uniformity, for additional information.

D. CALCULATING AN ADDITIONAL 10–20% WOULD PROCEED AS FOLLOWS:

- 28,516 + 10% (.10 x 28,516) = 31,368 gallons/acre; 28,516 + 20% (.20 x 28,516) = 34,239 gallons/acre. Dividing each of the above by the irrigation system output results in the following: 31,368 gallons/acre divided by 19,800 gallons/hour/acre = 1.6 hours of irrigation time each week. 34,239 gallons/acre divided by 19,800 gal/hour/acre = 1.7 hours of irrigation time each week. These totals of 1.6 and 1.7 hours/week should also be divided into 2–3 irrigation sets each week for annual vegetables.

EXERCISE 3

The following sample calculation will show you how to calculate the amount of irrigation time and frequency of irrigations required to replace the amount of water lost through evapotranspiration from a 100-square-foot garden bed.

A. CALCULATING THE NUMBER OF GALLONS LOST THROUGH EVAPOTRANSPIRATION (ET) IN A 100-SQUARE-FOOT GARDEN BED

- Daily average summer evapotranspiration rate (ET) in Santa Cruz = 0.15 inch/day
- Multiply this by 7 days/week = 1.05 inches/week
- 25-foot x 4-foot garden bed = 100 square feet
- 100 square feet x 144 (square inches/foot) = 14,400 square inches
- 100 square feet to 1 inch in depth = 14,400 cubic inches
- 1,728 cubic inches/ cubic ft.
- 1 cubic foot = 7.48 gallons
- 14,400 cubic inches (100-square-foot garden bed) divided by 1,728 cubic inches = 8.33 cubic feet
- 8.33 cubic feet x 7.48 gallons/cubic foot = 62. 31 gallons/week lost through ET

B. DRIP IRRIGATION OUTPUT CALCULATIONS

- Flow rate of high flow T-tape irrigation ribbon with 8-inch emitter spacing @ 10 psi = .74 gallons/minute/100 feet (assuming 100% efficiency)
- There are 133 emitters/100 ft @ 8-inch spacing
- .74 divided by 133 = 0.00556 gallons/minute/emitter
- .00556 X 60 (inches/hour) = .334 gallons/hour/emitter
- A 25-foot row of T-tape = 300 inches
- 300 inches divided by 8-inches emitter spacing = 37.5 emitters/row
- 37.5 emitters/row x 4 rows t-tape/bed = 150 emitters/ bed
- 150 x .334 gallons/hour/emitter = 50.1 gallons/hour

C. CALCULATING IRRIGATION REQUIREMENTS

- 62.31 gallons of water are lost from a single 100-square-foot garden bed through evapotranspiration each week. Four lines of high flow T-tape deliver 50.1 gallons/hour @ 10 psi. To calculate the amount of irrigation time required to replace the amount of water lost through ET, complete the following:
- 62. 31 gallons/week (ET) divided by 50.1 gallons/hour (output) = 1.25 hours (or 75 minutes) of irrigation time @ 10 psi. This application of water should be divided between two to three equally long irrigation sets each week, 40 or 25 minutes in length respectively.
- 20% more time should be added to compensate for evaporative losses, leakage, etc. These respective times should be increased to two 45-minute sets or three 30- minute sets/week.

Hands-On Exercises 4: Calculating a Water Budget for a One-Acre Block of Vegetables Using Sprinkler Irrigation

for the student

In the following exercise you will calculate the amount of irrigation time and frequency of irrigations required to replace the amount of water lost through evapotranspiration in your area from a one-acre block of vegetables using sprinkler irrigation.

EXERCISE 4

A. NUMBER OF GALLONS LOST THROUGH EVAPOTRANSPIRATION (ET) IN A ONE-ACRE FIELD:

- Step 1: Daily average summer evapotranspiration rate (ET) for an actively growing crop in full canopy in your area = _____ inches/day
- Step 2: Multiply this by 7 days/week = _____ inches/week

Given: There are 27,158 gallons of water in an acre inch (the amount of water needed to cover an acre to a 1-inch depth)

Given: An acre = 43,560 square feet (roughly 208 feet x 208 feet)

- Step 3: Multiplying _____ inches/week (ET) x 27,158 gallons/acre inch = _____ gallons/acre of water lost each week through evapotranspiration in an actively growing crop in full canopy in your area.

B. SPRINKLER IRRIGATION OUTPUT CALCULATIONS

- Step 4: Flow rate in gallons per minute (gpm) from an individual sprinkler head _____
- Step 5: Given: There are roughly 109 sprinkler heads per acre using 20 foot pipes set 20 feet apart. (20 feet x 20 feet = 400 square feet. 43,560 square feet/acre divided by 400 = 109)
- Step 6: 109 sprinkler heads x _____ gallons/minute each = _____ gallons per minute
- Step 7: _____ gallons/minute x 60 minutes/hour = _____ gallons/hour/acre total

C. CALCULATING IRRIGATION REQUIREMENTS

- To calculate the amount of irrigation time required (in hours/week) to replace the amount of water lost through evapotranspiration each week, complete the following calculations:
- Divide the total in Step 3 _____ gallons/acre ET by the total in Step 7 _____ gallons/hour/acre from the irrigation system = _____ hours of irrigation time required each week. This total time should be divided in to 2–3 irrigation sets for mixed vegetable operations.
- * Note: It is also important to factor in an additional 10–20% for evaporative losses due to extreme heat and wind conditions. It is further advisable to use several rain gauges to check the actual amount applied and to assess uniformity of application.

Hands-On Exercises 5 & 6: Sample Calculations— How Much Water Do I Need? How Many Acres Can I Irrigate?

for the student

OVERVIEW

In the following exercises you will calculate the total rate and volume of irrigation water that must be delivered to support two hypothetical farming operations. This information will help you determine the irrigation system needed to support the delivery of this volume of water.

EXERCISE 5: HOW MUCH WATER DO I NEED?

- I have 10 acres that I want to farm. The climate is Mediterranean with a fairly dry summer season. There is no well or pump on the property. The property is situated over an aquifer that has an adequate water supply. I have adequate capital to invest in a well and pump to supply irrigation water for my farm. I need to decide how much water I need (flow rate in gallons per minute) to irrigate the entire 10 acres, so that I can have the proper-sized well and pump installed.

GIVEN:

- At any time during the summer the entire 10 acres may be in production
- The daily average evapotranspiration rate (ET) during the summer months is about 0.30 inch per day
- There are 27,158 gallons of water in an acre inch
- You only plan to run the pump 12 hours per day
- There are 10,080 minutes per week (60 minutes/hour x 24 hours/day x 7 days/week)
- There are 5,040 minutes per week at 12 hours per day (10,080 divided by 2)

SOLUTION

1. Multiply 0.30 inches (ET) by 7 (days per week) to get 2.1 inches per week
2. Assume that your application will be 75% efficient and multiply 2.1 (inches per week) by 1.25 to get 2.625 inches per week (application rate to supply actively growing crops with adequate moisture for maximum yield during summer months)
3. Multiply 2.625 inches per week by 27,158 (gallons per acre inch) to get 71,290 gallons per acre per week
4. Multiply 71,290 (gallons per week) by 10 (acres) to get 712,900 gallons per week
5. Divide 712,900 (gallons per week) by 5,040 (minutes per week at 12 hours per day) to get 141.44 gallons per minute

Your pump and well will have to deliver 141.44 gallons of water per minute to keep your 10-acre farm productive during the summer months. If you were willing to irrigate 24 hours per day you would only need an output of 70 GPM (gallons per minute).

EXERCISE 6: HOW MANY ACRES CAN I IRRIGATE?

Someone has just offered you 10 acres of farmland in the Pajaro Valley on the central coast of California. There is a pump and well on the property capable of delivering 15 GPM. There are no other sources of water in the area. Your daily average ET in the summer is 0.20 inch. How many acres of irrigated vegetables can you plant during the summer months without running short of water?

GIVEN

- The daily average ET during the summer months is about 0.20 inch per day
- There are 27,158 gallons of water in an acre inch
- The pump flow rate is 15 gallons per minute
- You are only able to run the irrigation 12 hours per day during peak use

SOLUTION

1. Multiply 15 gallons per minute (GPM) by 60 (min per hr) to get 900 gallons per hour
2. Multiply 900 gallons per hour by 84 (hours per week @ 12 hours per day) to get 75,600 gallons per week maximum pump output
3. If your average ET during the summer months is .20 inches per day for an actively growing crop in full canopy, then multiply .20 (daily ET) by 7 (days per week) to get 1.4 inches per week
4. Multiply 1.4 (inches per week ET) by 27,158 (gallons per acre inch) to get 38,021 gallons per acre per week to keep your full canopy crops supplied with adequate water during the summer months
5. Assuming your application efficiency is 75%, multiply 38,021 by 1.25 to get 47,526 gallons per week
6. Divide 75,600 (maximum pump output per week) by 47,526 (weekly crop need per acre) to get 1.6 acres

Your 15 GPM well is capable of irrigating 1.6 acres of actively growing crop in full canopy during the summer months assuming 75% application efficiency and with application happening 12 hours per day. If you are willing to irrigate 24 hours per day then you can irrigate 3.2 acres.

If you increase your efficiency by only using overhead during the night, and utilize drip tape, you could increase your crop area slightly. If you plant crops with a low moisture requirement and if your soil and climate are conducive to dry farming (deep clay soil, mild summer temperatures, and at least 30 inches of precipitation annually during the winter) you might be able to farm the entire 10 acres.

Assessment Questions

- 1) Describe four functions of water in an agricultural system.

- 2) What is soil saturation?

- 3) What is field capacity?

- 4) What is the level of soil moisture at which most crop plants require additional water?

- 5) Describe two ways that agriculturists determine the need for irrigation.

- 6) Number the following stages of crop development in terms of their sensitivity to drought/water stress (1 being most sensitive and 4 being least sensitive):
 - _____ Flowering
 - _____ Yield formation/fruit set
 - _____ Early vegetative growth
 - _____ Fruit ripening

- 7) The soil water condition between field capacity (FC) and permanent wilting point (PWP) is referred to as:

Assessment Questions Key

1) Describe four functions of water in an agroecosystem.

- *plant support/turgidity*
- *nutrient transport (soil solution)*
- *plant cooling through transpiration*
- *plant nutrient (photosynthesis)*
- *soil moisture for soil organisms*

2) What is soil saturation?

When water is filling all the available pore spaces in a given soil

3) What is field capacity?

A soil is at field capacity when the free water/gravitational water drains from a saturated soil

4) What is the level of soil moisture at which most crop plants require additional water?

50% of field capacity

5) Describe two ways that agriculturists determine the need for irrigation.

- *Qualitative: Measuring for relative percentages of field capacity in the root zone of the crop*
- *Quantitative: Determining the evapotranspiration rate of a given site and systematically replacing the amount of water lost each week through calibrated water delivery systems*

6) Number the following stages of crop developmental in terms of their sensitivity to drought/water stress (1 being most sensitive and 4 being least sensitive):

1. *Flowering*
2. *Yield formation/fruit set*
3. *Early vegetative growth*
4. *Fruit ripening*

7) The soil water condition between field capacity (FC) and permanent wilting point (PWP) is referred to as:

Plant available water (PAW)

Resources

PRINT RESOURCES

TECHNICAL RESOURCES

Cleveland, David A. and Daniela Soleri. 1991. *Food from Dryland Gardens: An Ecological and Social Approach to Small-Scale Household Food Production*. Tucson, AZ: Center for People, Food and the Environment.

An overview of small-scale and community-based food production techniques intended for use by development educators and rural organizers in less developed nations. Encourages the development of gardens that serve local needs, that are based on local knowledge, and that conserve natural resources and the biodiversity of traditional crops. Includes an excellent section on the principles and practices of low-technology garden-scale irrigation.

Hanson, Blaine. 2009. *Measuring Irrigation Flow Rates*. Publication 21644. UC Irrigation Program, UC Davis. Oakland, CA: University of California Division of Agriculture and Natural Resources.

Provides growers and irrigation professionals with information about devices typically used to measure flow rates on farms. Includes descriptions of the various flow meters, their installation and operation, and the calculations for determining flow rates and amounts of applied water.

Hanson, Blaine, Larry Schwankl, and Allen Fulton. 2004. *Scheduling Irrigations: When and How Much Water to Apply*. Publication 3396. UC Irrigation Program, UC Davis. Oakland, CA: University of California Division of Agriculture and Natural Resources.

A technical reference for irrigation tools and techniques used in production agriculture. Includes many common calculations used to determine when to irrigate and how much water to apply.

Hanson, Blaine, Larry Schwankl, Steve Orloff, and Blake Sanden. 2011. *Sprinkle Irrigation of Row and Field Crops*. Publication 3527. Oakland, CA: Division of Agriculture and Natural Resources.

Provides practical information on the design, management, and maintenance of the sprinkle irrigation methods commonly used in California

for irrigating field and row crops. Discusses energy and management considerations such as when to irrigate, how much water to apply, and how to monitor soil moisture, offers design considerations and troubleshooting ideas, and provides an overview of system uniformity and efficiency.

Hanson, Blaine, Larry Schwankl, and Terry Prichard. 1999. *Micro-irrigation of Trees and Vines*. Publication 94-01. UC Irrigation Program, UC Davis. Oakland, CA: Division of Agriculture and Natural Resources.

Offers an overview of the rationale for micro-irrigation and how to assemble, operate, and maintain such a system.

Hanson Blaine, Steve Orloff, and Blake Sanden. 2007. *Monitoring Soil Moisture for Irrigation Water Management*. Publication 21635. UC Irrigation Program, UC Davis. University of California, Agriculture and Natural Resources: Oakland, California.

Describes techniques for monitoring soil moisture as an alternate method to water-based balance methods of managing irrigation water. Using this method you can “see” what is going on in the soil and determine answers to some key irrigation management questions.

Schwankl, Larry, Blaine Hanson, and Terry Prichard. 2008. *Maintaining Micro Irrigation Systems*. Publication 21637. UC Irrigation Program, UC Davis. Oakland, CA: University of California Division of Agriculture and Natural Resources.

Discusses the maintenance issues of microirrigation systems that can be used on tree crops, row crops, and trees and vines.

RESOURCES ON WATER ISSUES

California Roundtable on Water and Food Supply. 2011. *Agricultural Water Stewardship: Recommendations to Optimize Outcomes for Specialty Crop Growers and the Public in California, June 2011*. Ag Innovations Network.

California Roundtable on Water and Food Supply. 2014. *From Crisis to Connectivity: Renewed Thinking about Managing California's Water and Food Supply*, April 2014. Ag Innovations Network.

Roundtable members identified agricultural water stewardship as a key area of importance for sound long-term water management. The group held a series of meetings to build a common understanding of agricultural water use, develop a unified set of principles that underlie long-term solutions, and create recommendations for decision-makers and the public on balanced solutions to tough agricultural water issues. These reports are the product of those efforts.

Carle, David. 2009. *Introduction to Water in California*. California Natural History Guides No. 76. Berkeley, CA: University of California Press.

Describes the journey of California's water, from snowpack to field and faucet. Discusses the role of water in agriculture, the environment, and politics, and includes an update on recent water issues facing the state.

Donahue, John M., and Barbara Rose Johnston. 1997. *Water, Culture, and Power: Local Struggles in a Global Context*. Washington, DC: Island Press.

Presents a series of case studies from around the world that examine the complex culture and power dimensions of water resources and water resource management.

Mount, Jeffrey F. 1995. *California Rivers and Streams: The Conflict between Fluvial Process and Land Use*. Berkeley, CA: University of California Press.

Provides an overview of processes shaping California's rivers and watersheds, and the impact on water-ways of different land use practices, including agriculture.

Pielou, E. C. 1998. *Fresh Water*. Chicago, IL: University of Chicago Press.

A natural history of fresh water that includes an explanation of the dynamics of the water cycle and groundwater.

WEB-BASED RESOURCES

Appropriate Technology Transfer for Rural Areas (ATTRA) – Drought Resource Guide

attra.ncat.org/downloads/drought_RL.html

Provides a list of journals and websites with information on general farm management practices that can help mitigate the impacts of drought conditions. Accompanies ATTRA Powerpoint presentations on drought.

California Agricultural Water Stewardship Initiative
agwaterstewards.org

The California Agricultural Water Stewardship Initiative (CAWSI) works to raise awareness about approaches to agricultural water management that support the viability of agriculture, conserve water, and protect ecological integrity in California. A project of the Community Alliance of Family Farmers, CAWSI's website includes a resource library, case studies, information on on-farm practices, an events calendar, and other resources.

California Irrigation Management Information Systems (CIMIS)

www.cimis.water.ca.gov

California weather information site designed to help growers, turf managers, and others properly time irrigation applications.

Drought Proofing Your Farm Checklist

aginnovations.org/agwaterstewards.org/uploads/docs/Cahn-drought_proofing_checklist.pdf

Based on a presentation at the 2010 Ecological Farming Conference in Asilomar, CA by Michael Cahn, Cooperative Education irrigation and water resources advisor for Monterey County. Outlines general strategies and specific steps to take in drought proofing your farm.

Effective Irrigation Practices To Improve Short Term and Long Term Water Management

[ftp://ftp-fc.sc.egov.usda.gov/CA/news/Publications/factsheets/effective_irrigation_practices.pdf](http://ftp-fc.sc.egov.usda.gov/CA/news/Publications/factsheets/effective_irrigation_practices.pdf)

Provides step-by-step guidelines to maximize distribution uniformity, minimize evaporation losses, and optimize water application timing and amount decisions for a variety of irrigation systems, including furrow irrigation, hand-moved and solid set sprinklers, microirrigation, and drip irrigation.

Estimating Soil Moisture by Feel and Appearance.
USDA NRCS Program Aid Number 1619

www.nrcs.usda.gov/wps/portal/nrcs/detail/mt/newsroom/?cid=nrcs144p2_056492

PDF available at: www.ext.colostate.edu/sam/moisture.pdf

This user-friendly guide describes how to use the “feel and appearance” method to estimate soil moisture. Includes photos of a range of soils at various moisture levels and provides useful guidelines for estimating soil moisture conditions, e.g., by using the “squeeze test.”

Irrigation Scheduling: The Water Balance Approach.

www.ext.colostate.edu/pubs/crops/04707.html

Describes the water balance approach to irrigation scheduling.

Measuring and Conserving Irrigation Water

attra.ncat.org/attra-pub/summaries/summary.php?pub=332

Describes how to find the net water application rate for any irrigation system. Explains how to calculate the number of hours the system should be operated, describes several ways to measure flowing water in an open channel or pipeline, and offers suggestions for irrigating with limited water supplies.

Methods of Determining When To Irrigate. Cooperative Extension, College of Agriculture and Life Sciences, The University of Arizona.

cals.arizona.edu/pubs/water/az1220/

Details a variety of techniques used to determine irrigation scheduling, including the “feel method,” tensiometers and other soil moisture measuring devices, infrared thermometers that measure the temperature of the plant canopy, and computerized irrigation models.

UC Davis Small Farm Center, Family Farm Series Publications: Vegetable Crop Production—Tips on Irrigating Vegetables

www.sfc.ucdavis.edu/Pubs/Family_Farm_Series/Veg/vegcrop.html

Information on pre-irrigation, timing, irrigation system options, and other useful tips for irrigating vegetable row crops.

UC Division of Agriculture and Natural Resources: Institute for Water Resources, Water and Drought Online Seminar Series

ciwr.ucanr.edu/California_Drought_Expertise/Insights__Water_and_Drought_Online_Seminar_Series/

This online seminar series from the University of California, Agriculture and Natural Resources, developed with support from the California Department of Water Resources, brings timely, relevant expertise on water and drought from around the UC system and beyond directly to interested communities. Topics include using agroecological practices to enhance the resilience of organic farms to drought, vineyard irrigation with limited water, saving water in the landscape, and much more.

UC Division of Agriculture and Natural Resources: Irrigation

www.anrcatalog.ucdavis.edu

Publications and instructional materials on irrigation.

The WATER Institute

www.oaecwater.org

The WATER Institute (Watershed Advocacy, Training, Education, & Research), based at the Occidental Arts and Ecology Center in Occidental, California, promotes understanding of the importance of healthy watersheds to healthy communities. The Institute’s website offers numerous resources and links to important readings about water politics, conservation, traditional practices, and water history.

SUPPLEMENT 1

Evapotranspiration (ET) & Factors that Affect ET Rates

Many factors affect ET, including weather parameters such as solar radiation, air temperature, relative humidity, and wind speed; soil factors such as soil texture, structure, density, and chemistry; and plant factors such as plant type, root depth, foliar density, height, and stage of growth.

Evapotranspiration (ET) = Evaporation + Transpiration

Evaporation is the transformation of water from a liquid into a gas. Water volatilizes into the air easily, especially when it is hot and windy. Evaporation happens only at the surface of a liquid, so the greater the surface area-to-volume ratio of the water, the greater the evaporation rate. This means that you lose more water to evaporation from water sprayed in drops into the air than you do from water in a drip tape line or in an irrigation canal or ditch.

The evaporation rate (i.e., the time it takes for a certain amount of water to volatilize) for a given day can be measured. One way is by placing a known quantity of water in a container of a known surface area and timing how long it takes to disappear. In California, we can also look up this value on a state-run website indexed by geographical area, the California Irrigation Management Information System website, www.cimis.water.ca.gov.

Transpiration is the transformation and use of water by a plant. The plant uses water to transport nutrients and air, to maintain its structure, and to thermoregulate (maintain optimal temperature). The transpiration rate of a plant is the amount of water a plant uses up over a given amount of time. This value is harder to measure, as it is difficult to assess the minimum amount of water that a plant needs to be healthy. The plant could be using less water than you are giving it. You could measure this in a very controlled environment by giving similar plants different amounts of water and seeing the effects. Fortunately, this can also be looked up. Transpiration rates found in reference tables are generally for mature plants; any plants that are working more (flowering, setting fruit, at a critical stage of growth,

etc.) will transpire more. It is equivalent to breathing for us – adults use more air than children do, you use more when you are exerting yourself, etc.

Evapotranspiration or ET is the combined use of water by plants and loss of water into the air (see Appendix 1: Soil Moisture Terms, for an illustration). The evapotranspiration rate is the amount of water that needs to be replaced over a given amount of time to make up for the water that has been used or volatilized. The evapotranspiration rate is measured for mature plants in a given region on a given day.

Precipitation and irrigation are the two primary sources of water that plants use. Plant leaves and soil surfaces temporarily retain some part of the water applied to the field, but this part readily evaporates. What remains percolates into the soil. Plants extract the infiltrated water through their roots and transport it up to their leaves for photosynthesis. In addition to water, plants need carbon dioxide (CO₂) and light for photosynthesis. In order to take in CO₂ from the atmosphere, plants open their stomata, the microscopic pores on the undersides of leaves. It is during this process that they lose water to the atmosphere.

Some Environmental Factors Affecting the Rate of Transpiration

LIGHT

Plants transpire more rapidly in the light than in the dark. This is largely because light stimulates the opening of the stomata. Light also speeds up transpiration by warming the leaf.

TEMPERATURE

Plants transpire more rapidly at higher temperatures because water evaporates more rapidly as the temperature rises. At 86°F, a leaf may transpire three times as fast as it does at 68°F.

HUMIDITY

When the surrounding air is dry, diffusion of water out of the leaf happens more rapidly.

WIND

When there is no breeze, the air surrounding a leaf becomes increasingly humid thus reducing the rate of transpiration. When a breeze is present, the humid air is carried away and replaced by drier air.

SOIL WATER

A plant can continue to transpire rapidly if its water loss is made up by replacement water from the soil. When absorption of water by the roots fails to keep up with the rate of transpiration, loss of turgor (rigidity caused by pressure of water against cell walls) occurs and the stomata close. This immediately reduces the rate of transpiration (as well as of photosynthesis). If the loss of turgor extends to the rest of the leaf and stem, the plant wilts.

The volume of water lost in transpiration can be very high. It has been estimated that over the growing season, one acre of corn plants may transpire 400,000 gallons of water. As liquid water, this would cover the field with a lake 15 inches deep.

SUPPLEMENT 2

Overview of the “Water Budget Approach” to Irrigation Management

Water budgets are analogous to maintaining a balanced checkbook. Additions of irrigation water or rainwater are “deposits” and water use by plants as well as evaporation from the soil surface are “withdrawals.” The starting point for a water budget is a soil saturated from either irrigation or rainfall. From that initial point of saturation, water depletion is monitored and water is applied as needed to maintain a “balanced” system to optimize plant growth.

This “quantitative” water budget approach to irrigation scheduling has been used successfully by large-scale farming operations in arid regions of the western United States since the early 1980s. Through a network of regional weather stations, daily weather data including reference ETo is made available to growers in many agricultural regions throughout the west. Weather information from these stations is commonly used by large-scale irrigation managers and research plot managers to assist in accurately determining how much water to apply to crops in order to avoid over application of irrigation water, while at the same time maximizing crop yields of agronomic, orchard and vegetable crops. Though this system of irrigation scheduling is simply not practical or appropriate for diverse small-scale agricultural systems, many of the principles are applicable and can be effectively used by irrigation managers of smaller scale systems as a means of increasing overall irrigation efficiency on their farms and in their gardens.

From an irrigation standpoint the most important data from this network of weather stations is what is referred to as “reference crop evapotranspiration” (ETo). The ETo is the estimated daily rate of evapotranspiration from a reference crop, which is either grass or alfalfa in full canopy. In most locations these data are given in “inches per day.” With these data a grower can calculate “crop evapotranspiration” (ETc) and determine how much water to apply to an actively growing crop.

The other critical piece of information needed for the irrigation rate calculation is the “crop coefficient” (Kc). The crop coefficient reflects the stage of growth of the crop from seedling through full canopy. Crop Coefficient (Kc) information is

available for a limited number of economically important crops typically produced in large-scale systems. For this reason this system of irrigation management is typically not used in small-scale diverse systems. In its simplest terms the crop evapotranspiration rate (ETc) equals the crop coefficient (Kc) multiplied by the reference crop evapotranspiration rate (ETo).

$$ETc = Kc \times ETo$$

Using corn as an example:

- A corn crop at 10 days from emergence would have an estimated Kc value of .25
- A corn crop at 45 days from emergence would have an estimated Kc value of .50
- A corn crop at 100 days from emergence would have an estimated Kc value of 1.00

If the corn crop had been irrigated at time of planting and the daily ETo averaged .15 inches per day for the first ten days since emergence, then your irrigation calculation for day ten would be as follows:

$$ETc = .25 (Kc) \times 1.5 (.15" ETo \text{ per day} \times 10 \text{ days})$$

$$ETc = .375 \text{ inches}$$

Based on this equation would you irrigate the corn with .375 inches of water on day ten?

You might be better off accessing soil moisture using a shovel and the “feel” method at this growth stage. The Kc is not an absolute number but only an estimate since it would change on a daily basis from emergence of the crop through to maturation. What is most important to understand from this example is that most vegetable crops, when in full canopy, have a Kc value of 1. If we can get an accurate estimation, from a local weather station, of

the average ETo rate then we can easily determine an approximate weekly rate of irrigation for most crops —when in full canopy—typically grown in small-scale diverse systems.

For example if our average ETo is about .15 inches per day then we would need to apply roughly 1 inch per week of irrigation water to a crop in full canopy.

$E_{To} .15'' \text{ per day times } 7 \text{ days per week} = 1.05''$

There are many other considerations to take into account when making irrigation decisions, including soil type, crop type, time of harvest, and irrigation system application uniformity, but the “water budget” method of irrigation rate calculation does, when used properly, provide a basis for sound decision making in small-scale farms and garden—especially when used in conjunction with the “feel” method.

SUPPLEMENT 3

Soil Moisture Sensing Instruments Commonly Used for Irrigation Scheduling

Information from soil moisture sensing instruments can help inform decisions about when and how much to irrigate vegetable, vine, and tree crops. Although these instruments can't replace the knowledge and experience gained from both qualitative ("by feel") and quantitative approaches to measuring soil moisture discussed elsewhere in this unit, they can be used in tandem with these methods to help determine crops' needs.

There are a number of soil moisture sensors available to growers, but two general categories have come to be industry standards because of their relative low cost, accuracy, reliability, and ease of use. Currently, tensiometers and electrical resistance sensing devices (ERSDs) are the instruments most commonly used in California's Central Coast region.

Tensiometers

In simple terms, a tensiometer is a tightly sealed plastic water-filled tube with a semi-porous ceramic tip at the bottom, which is buried in the soil. A vacuum gauge near the top of the tube (above grade) provides constant readings that reflect soil moisture conditions at the depth of the ceramic tip.

Starting from a point of field capacity, as plant roots extract available water from the soil, water is pulled from the sealed tensiometer tube into the surrounding soil. This "pull" or "tension" is measured in centibars on the vacuum gauge attached to the tensiometer. The dryer the soil becomes, due to plant extraction of irrigation water, the higher the centibar readings; thus a reading of 0 reflects saturation and a reading of 100 reflects very dry soil. Irrigation is often required at readings between 30 and 50 centibars, although this can vary considerably depending on crop, soil type, and climate.

Placement

Tensiometers are placed directly into the most active part of the crop's root zone, at depths ranging from 6 inches to as deep as 48 inches. The most common placement depths are 6 and 12 inches for shallow-rooted crops (e.g., strawberries).

Two tensiometers are often placed next to each other so that soil moisture can be monitored at

different depths at the same location. The deeper location tends to maintain a higher percentage of moisture compared to the more shallow placement, and this difference provides the irrigator with a good representation of below-ground moisture dynamics that can be a great help in determining both timing and amounts of water needed to meet the crop's needs over time.

Tensiometers should be placed at a number of locations across the field to reflect different soil and irrigation conditions. They should be left in place for the duration of the crop cycle and read as often as once a day to inform irrigation scheduling decisions.

Placement location and method of installation are critical for accuracy. Tensiometers should be placed within the root zone directly in the "wetted" area that receives either drip or sprinkler irrigation. In sprinkler-irrigated systems, place the tensiometers between sprinkler risers where maximum uniformity is often observed. In drip-irrigated systems, place the tensiometers off to the side of the drip line but still within the wetting pattern of the drip.

Prior to placing the tensiometer in the soil the semi-porous ceramic tip must be soaked in water overnight to insure that it is adequately moist so that water can easily move from the sealed tube into the surrounding soil.

To install the tensiometer the irrigator makes a hole in the ground to the desired depth and the same diameter as the tensiometer. There are dedicated tools for this purpose, but a soil probe can be used as long as it is the same diameter as the tensiometer. A slurry of soil and water is poured into the bottom of the hole to ensure good tensiometer-soil contact (critical for accurate readings), and the tensiometer is then pushed into place in the hole. The tensiometer location should be marked with a flag to

facilitate locating the instruments for monitoring. Once installed it usually takes several readings over a period of several days to start getting accurate readings.

Tensiometers have a water reservoir above the sealed column of water that resupplies the plastic column, since the plant roots constantly extract very small quantities of water from the sealed tube. To refill the sealed tube the irrigator simply unscrews the cap on the reservoir and this opens the seal below the reservoir, allowing the excess water in the reservoir to flow into the lower tube. Once the tube is filled, a small hand-held suction pump is used to remove air bubbles from the tube. The lid of the reservoir is then retightened, sealing the lower tube. It is important to follow all of the manufacturer's recommendations for installation and maintenance, including the use of an additive to minimize algal contamination of the water in the tensiometer.

When used properly, tensiometers will provide accurate "soil/water tension" readings on a range of crops. These readings provide the irrigation manager with critical information that can be used to establish irrigation schedules adequate to maintain soil moisture at levels conducive to good crop growth and productivity.

Electrical Resistance Sensing Devices

In many ways electrical resistance sensing devices (ERSDs) are similar to tensiometers—the main difference is the method used to measure soil moisture. ERSDs utilize two "electrodes" cast into a porous material (often gypsum based). The two electrodes in the "block" are attached to wires that run from the ERSD to the surface. These wires are often protected within a ½-inch PVC tube that is attached to the ERSD. The ESRDs are buried in the soil at various

depths and locations, similar to tensiometers, and like the tensiometer, a soil/water slurry is used when the ERSD is installed to establish good soil contact with the instrument.

To get a reading from the ERSD the irrigator uses a small, inexpensive, hand-held electrical resistance meter that is temporarily connected to the wire leads from the buried ERSD. The meter allows a very low electrical current to flow between the two electrodes in the ERSD and displays an electrical resistance reading. This reading reflects the amount of moisture within the porous material, since the buried ERSD takes on the moisture properties of the surrounding soil. Due to the electrical conductivity potential of water, the higher the concentration of moisture within the porous block the lower the resistance and, conversely, the lower the concentration of moisture within the block the higher the resistance.

At field capacity the block is wet; as the growing plants start to extract moisture from the soil, the moisture is also pulled from the ERSD and the conductivity reading will reflect this change in soil moisture. Note that high salt concentrations in the soil solution will affect the accuracy of the reading, since salts increase electrical conductivity. This potential salt impact needs to be taken into account when deciding which monitoring tool is best suited to your farm.

Electrical resistance sensing devices are relatively inexpensive and easy to install and monitor. Like tensiometers, they are left in the field for the duration of the cropping cycle and provide critical irrigation scheduling information that enables the irrigation manager to make informed decisions about irrigation frequency and quantity based on site-specific data.

SUPPLEMENT 4

Overview of Dry Farming on the Central California Coast

“Dry farming” is a term that growers and consumers on California’s Central Coast use to describe summer- and fall-harvested orchard, vineyard, and vegetable crops grown without supplemental irrigation following planting. Rather than rely on irrigation, dry-farmed crops draw on a reserve of soil moisture “captured” by the grower following winter and early spring rains.

A limited number of geographic regions are suited to dry farming, which requires adequate winter rainfall and, in the case of annual crops, a summertime marine influence that generates cool mornings and warm afternoons. These conditions, combined with careful soil preparation, appropriate variety selection, adequate plant spacing, and vigilant weed control are all required for successful dry farming.

A Note About Dry Land Farming

“Dry land farming” is another term commonly used in agricultural production. The term typically refers to winter grain production on non-irrigated cropland. Dry land grain is planted in fall and harvested in spring/early summer, relying on winter rainfall for growth and development. A dry land grain crop usually requires between 10 and 15 inches of annual precipitation for economic yields. In areas where rainfall is less than 10 inches, with careful soil management, grain can be produced every other year.

The important distinction between dry farming and dry land grain production is that the grain crop is “rain irrigated” during most of its growth cycle. In contrast, dry-farmed crops experience little or no rainfall during the growth cycle of the crop. In this supplement we are specifically referring to “dry farming.”

Criteria for Successful Dry Farming

MEDITERRANEAN CLIMATE

Central California’s Mediterranean climate creates the conditions that make dry farming possible. In normal years Central Coast rainfall is generated by storms that develop in the Gulf of Alaska and sweep south and then east, moving from the Pacific Ocean across the region from November through

February and into March. High pressure then dominates the region from April through September and often into October, pushing rainfall to the north during the Central Coast’s long “summer drought.” Thus the region rarely receives significant rainfall from May through September.

Rainfall amounts vary considerably across the Central Coast, influenced in large part by the location, height, and orientation of the area’s numerous mountain ranges. Steeper ranges parallel to the coast can cause significant orographic (mountain-induced) lifting of moisture-laden air, resulting in high rainfall amounts on the west side of these slopes. These ranges also create rain shadows on the east (inland) sides, reducing rainfall in these areas. From San Luis Obispo County in the south to San Mateo County in the north, rainfall amounts vary from approximately 8 inches up to approximately 35 inches per year depending on the effects of the mountain ranges and specific storm dynamics.

ADEQUATE WINTER RAINFALL

A minimum of 20 inches of rainfall during the rainy season is required to create an adequate reserve of soil moisture for growing most dry-farmed crops. The challenge for the dry-farm grower is to capture and hold as much of this precipitation in the soil as possible so that the spring-planted dry-farmed crops can access this “stored” moisture during the dry summer months.

MARITIME INFLUENCE

The valleys along the coast in Central California that receive significant summer time marine influence in the form of early morning fog and mild afternoon high temperatures (highs in the mid 80’s) and evapotranspiration (ET) rates in the range of .15 inches per day are ideal for dry farm production.

Higher afternoon temperatures and ET rates in the range of .33 inches per day, typically encountered in the more inland valleys with less marine influence, are much less suited to dry farming, especially of tomatoes, since it can be difficult for the plants to access deeper moisture quickly enough to maintain turgidity during periods of high evapotranspiration. However, some crops can be successfully dry farmed in inland valleys: although not within the scope of this article, wine grapes, olives, and apricots are successfully dry farmed in California on small acreages in areas with little or no maritime influence.

SOIL TYPE

The best soils for dry farming have relatively high clay content. Sandy loam soils or loam soils that overlay deeper clay soils also work well for dry farming. Soils higher in sand content do not hold soil moisture as well as clay and clay loam soils and therefore are typically not used for dry farming. And because organic matter increases the soil's porosity, it does not improve conditions for dry farming.

A grower considering dry farming should bore numerous holes up to 4 feet deep throughout the production area using a 2-inch slide hammer and soil probe to obtain soil "plugs": soils suitable for dry farming will exhibit continuity within the different horizons and a loam or sandy loam upper horizon going directly to clay. Horizons with a larger particle size, e.g., containing sand or gravel, will impede water's ability to be drawn upward to the plant's root zone, thus making dry farming less feasible. Preparing and planting a small area of the field is the best way to determine whether the site and conditions are suited to dry farming.

Soil Preparation

Soil preparation that conserves or "traps" winter rainfall is critical for successful dry farming. In the spring, prior to planting, residual rain moisture is typically lost from the root zone as water percolates down through the soil horizon with the help of gravity. High clay content in the soil, and to a lesser extent soil organic matter (humus), greatly facilitates the soil's ability to hold water in the root zone against the pull of gravity.

As the weather warms, soil moisture is also lost through surface evaporation. Evaporation occurs as water is drawn upward via small channels between

soil particles; these channels can be thought of as capillaries within the soil horizon. Polar bonds between water molecules and the forces of cohesion facilitate water's upward movement through the soil: as water near the soil surface evaporates, water lower in the soil is pulled nearer the surface, much like liquid being drawn through a straw. Thus in fields destined for dry farming it is critical to break up the capillaries near the surface to minimize the evaporative loss of residual rain moisture during late spring and summer.

This breaking of capillaries is typically accomplished with relatively shallow (8"–10") mechanical soil tillage. Commonly used tillage tools include rototillers and disc harrows, often followed by secondary tillage implements such as spring tooth harrows. The resultant tilled zone is called a "dust mulch." This dust mulch provides an effective barrier to the potential evaporative loss of residual rain moisture held within the root zone of the soon-to-be-planted dry-farmed crop.

When creating the initial dust mulch, timing is critical: the grower must trap as much rain moisture in the soil as possible, yet avoid working the soil when it is too wet. Wet soils, especially "heavier" soils high in clay content, are subject to clod formation and compaction caused by tractor operations.

It is also important to minimize tillage depth when preparing soil for planting annual dry-farmed crops, since deeper tillage could disrupt the lower soil capillaries that are critical for soil water movement below the tilled zone. The dust mulch needs to be maintained with fairly frequent and light tillage operations (every two or three weeks) from the time of initial tilling until the crops are too large to cultivate effectively.

Although dry farming relies on winter rainfall, several scenarios can necessitate irrigation prior to planting. During dry springs it is sometimes necessary to pre-irrigate the beds before planting using either overhead irrigation or drip lines in order to establish an optimal stand. When a mechanical spader is used to incorporate a high residue cover crop prior to dry farming it is often necessary, in the absence of post-tillage rain events, to pre-irrigate with overhead sprinklers to facilitate the cover crop's breakdown. On a garden scale, you may need to hand water the newly planted plants to assist in rooting and uniform establishment.

The typical springtime dry farm tillage and crop culture sequence at the UCSC Farm is as follows:

- 1 Flail mow cover crop
- 2 Incorporate cover crop residue with mechanical spader
- 3 Form beds with rolling cultivator
- 4 In the absence of rain, pre-irrigate beds with over head irrigation at a rate of 1.5 inches per acre (when spring rains are adequate this step is unnecessary)
- 5 Wait for weed flush and create dust mulch with rolling cultivator
- 6 Maintain dust mulch with rolling cultivator as needed until planting time
- 7 At time of planting break open bed middles with Alabama shovels and plant tomato transplants deeply into moisture using hand trowels
- 8 Cultivate with sweeps and side knives when first weeds appear in furrow bottoms or as necessary to maintain dust mulch
- 9 Once plants reach adequate height, reform beds by throwing dirt into bed middles with rolling cultivator —when timed well this last cultivation pass will also effectively smother weeds starting to establish within the plant line

Variety Selection

In any dry farming system, variety selection is absolutely critical. Varieties that do well as dry-farmed crops typically have an aggressive root system capable of reaching deep into the soil horizon to tap the stored rain moisture.

It is interesting to note that growers in the Central Coast region have trialed literally hundreds of varieties of heirloom, open pollinated and hybrid tomatoes and, to date, none have compared to ‘Early Girl’ in their ability to set roots deep and consistently produce a high yield of high quality, flavorful, and marketable fruits with no irrigation. ‘New Girl’, a recently introduced variety, is closely related to ‘Early Girl’ and appears to have many of the same favorable characteristics.

Plant Spacing and Weed Control

Dry-farmed crops with extensive root systems can effectively extract deep residual rain moisture from a fairly large area within their roots’ grasp. Competition from other nearby crop plants or weeds can result in water-stressed plants that produce very little fruit and remain stunted. For this reason it is critical to plant out dry-farmed crops in a much wider spacing than is typically used for irrigated crops of the same type. Good weed management in a dry farm system is also critical, since most weeds have aggressive root systems capable of outcompeting most crop plants for both water and nutrients.

As an example of plant spacing, irrigated tomatoes are commonly spaced 2 feet apart within the row with rows spaced 4 feet apart, a density of roughly 5,400 plants per acre. A typical spacing for dry-farmed tomatoes (depending on soil type and rainfall amounts) would be 6 feet between rows and 6 feet between plants, for a total plant population of 1210 plants per acre. As you can see from this example a significant yield reduction can be expected from most dry-farmed crops simply based on per acre plant populations. A higher price premium for dry-farmed tomatoes will often make up for the yield loss related to wider spacing.

Crops Suitable for Dry Farming

Tomatoes are the most notable dry-farmed crop produced in the Central Coast region. Dry-farmed tomatoes are typically transplanted into the field from May through June. It is advantageous to plant the tomatoes as deep as possible into the residual rain moisture after the dust mulch has been created and when soil temperatures are adequate for strong growth (>55 °F). Growers often plant several successions spaced 2 to 3 weeks apart to provide an extended fall harvest period. Some growers stake and tie the tomatoes for ease of harvest and to enhance fruit quality, while others let the plants vine out on the ground without support.

‘Early Girl’ and/or ‘New Girl’ are currently the tomato varieties of choice. The fruits are easy to handle, they don’t crack, and the flavor is remarkable. However, when grown without irrigation, these varieties are prone to a physiological condition known as blossom end rot. Blossom end rot is related to the plant’s inability to move calcium to the blossom end of the fruit, which is exacerbated when water is limited. The symptom is a black sunken spot on the blossom end of the fruit that—depending on the severity of the symptom—is prone to rot. Although the condition often becomes less prevalent as the season progresses, it may affect 10–20% of the crop. Fruit showing symptoms of blossom end rot are not marketable.

Other annual vegetable crops that have been successfully dry farmed in the Central Coast region include dry corn, dry beans, and winter squash, all of which are direct seeded into residual rain moisture after the creation of the dust mulch. In a trial conducted at the UCSC Farm in the mid 1990s we showed no significant difference in yield between irrigated and dry-farmed Red Curry, Butternut, and Spaghetti winter squashes.

Advantages of Dry Farming

As a rotation within a diverse irrigated cropping system, dry farming has many advantages. The lack of irrigation in a dry-farmed production block can lead to improved soil tilth, since dry surface soil is not prone to compaction or clod formation from both foot traffic associated with harvest and tractor com-

paction from cultivation operations. Problem weeds are much easier to deal with when irrigation is eliminated for a season and weed seed development is easily minimized in a dry-farmed block. If water is a limited resource on a farm then dry farming makes perfect sense as a means of maintaining production while eliminating the need for irrigation. Forcing deep rooting of dry-farmed crops can also facilitate the extraction of nutrients that have leached below the root zone of most irrigated crops through excessive rainfall or irrigation.

Dry farming also heightens the intensity of crop flavors. This is particularly true of tomatoes, which are highly sought after by savvy consumers and the Central Coast region’s chefs. As a result, the production and sale of dry-farmed tomatoes has become an important and economically viable niche market for small-scale organic specialty crop growers on the Central Coast.

Finally, although dry farming may not be appropriate for every cropping system and region, understanding the basic principles of dry farming can lead to a greater knowledge of the complexities of water and soil dynamics, tillage, weed management, and fertility management. This knowledge can in turn lead to a greater understanding of your particular production system. In regions where conserving water is critical, applying dry farming principles to irrigated systems can result in improved water use efficiencies, better weed management, and improved soil tilth and productivity.

SUPPLEMENT 5

Nitrate Contamination of Groundwater

Irrigation accounts for nearly one-third of all water use in the United States, or 128 billion gallons/day.¹ In arid western states, and California in particular, irrigation accounts for more than half of all water used. California uses about 24.4 billion gallons/day to irrigate some 9 million acres. This is about 6 times the amount of domestic water used by the entire U.S. population.²

While these statistics clearly illustrate the enormous quantity of water used in agriculture, they also suggest that irrigation has far-reaching consequences on water quality.

In an effort to maximize crop yields, many farmers apply nitrogen-based synthetic fertilizers. More than half of the nitrogen applied may go unused by crops, ending up in surface water runoff or leaching into groundwater and causing severe water quality and other public health concerns for rural communities, many populated by poor, immigrant farm workers.^{3,4} As this supplement illustrates, how farmers use irrigation and apply fertilizers affects not only their crops, but also their neighbors.

Synthetic nitrogen-based fertilizers were made possible because of the Haber-Bosch process, which converts stable, inert nitrogen gas (N₂) unavailable to plants into the reactive ammonia molecule (NH₃) readily available for plant uptake. Once the process was commercialized, synthetic fertilizer use skyrocketed, as farmers were no longer dependent only on their soil organic matter, compost, cover crops, and livestock manure for nitrogen. Fertilizer use in the United States increased from about 7.5 million tons

in 1960 to 21 million tons in 2010.⁵ In 2007, California farmers applied 740,00 tons of nitrogen in fertilizers to 6.7 million acres of irrigated farmland.⁶ With cheap sources of nitrogen and water available, our current agricultural system is based on the liberal application of synthetic fertilizers and irrigation water to ensure high yields, often at the expense of environmental and public health.

California's Central Valley is home to some of the most heavily fertilized cropland and some of the most polluted water in the United States. Communities there are particularly vulnerable to public health effects of nitrate contamination because groundwater provides drinking water for the majority of residents. Additionally, rural communities in the valley are generally poor and populated by immigrants and minorities least able to afford treatment costs and most vulnerable to discriminatory decision-making.

Tulare County, the second most productive agricultural county in California, includes many of these communities. Though it generates nearly \$5 billion in revenue from agriculture each year, it has the highest poverty rate in California and is populated mainly by minorities (66%), most of whom

1,2 Kenny, Joan F. et al. Estimated use of water in the United States in 2005. Circular 1344, pp. 23–24. U.S. Department of the Interior: U.S. Geological Survey. pubs.usgs.gov/circ/1344/pdf/c1344.pdf

3 J.L. Hatfield, J. L., and J. H. Prueger. 2004. Nitrogen over-use, under-use, and efficiency. New directions for a diverse planet, proceedings of the 4th International Crop Science Congress, 26 Sep – 1 Oct 2004, Brisbane, Australia. Published on CDROM. Website: www.cropscience.org.au

4 Moore, Eli, and Eyal Matalon. 2011. The human costs of nitrate-contaminated drinking water in the San Joaquin Valley. Pacific Institute. www.pacinst.org/wp-content/uploads/sites/21/2013/02/nitrate_contamination3.pdf

5 USDA, Economic Research Service. Fertilizer use and price. Table 1: U.S. consumption of nitrogen, phosphate, and potash, 1960-2011. www.ers.usda.gov/data-products/fertilizer-use-and-price.aspx#26720

6 Harter, Thomas. 2009. Agricultural impacts on groundwater nitrate. *Southwest Hydrology*, July/August 2009. www.swhydro.arizona.edu/archive/V8_N4/feature2.pdf

are Latino.^{7 8 9} The average per capita income in the county is \$18,021.¹⁰ Here, one in five small public water systems and two in five private domestic wells surpass the maximum contaminant level (MCL) for nitrates.^{11 12} As a result, residents of towns like Seville, East Orosi, and Tooleville are paying \$60 per month for nitrate-contaminated water they can't safely use, and must spend an additional \$60 to purchase bottled water for drinking and bathing. In contrast, San Francisco water customers pay \$26 per month for pristine water from the Hetch Hetchy water system in Yosemite.

The economic cost of nitrate contamination in drinking water is not the only cost to these communities. Farm workers make up a significant segment of the population of small towns throughout the Central Valley and are both directly exposed to the hazards of heavy fertilizer use in the fields and in the air, and through excess nitrogen leached into groundwater drinking supplies. Scientists estimate that 50–80% of nitrogen applied in fertilizer is unused by plants. Of that, about 25% volatilizes into the atmosphere (some as nitrous oxide, the most potent greenhouse gas). As a result, approximately 30–50% of nitrogen applied in fertilizer—about 80 pounds per acre in California—leaches into groundwater beneath irrigated lands and into public and private water supplies.¹³

High nitrate levels in water can cause a number of health problems, including skin rashes, eye irritation, and hair loss. More severe is “Blue Baby Syndrome” (methemoglobinemia), a potentially fatal blood disorder in infants caused by consumption of nitrate-contaminated water. Direct ingestion, intake through juices from concentrate, and bottle-fed infant formula are all potential threats to children. Nitrate contamination has also been linked to thyroid cancer in women. Widespread contamination of groundwater through leached fertilizer has rendered drinking water in rural communities across the country not only unusable, but dangerously so.

While nitrate contamination is an acute problem in California, it exists across the country. The EPA estimates that over half of all community and domestic water wells have detectable levels of nitrates.¹⁴ Rural communities that rely on private wells (which are unregulated), or lack access to adequate water treatment facilities, have the most insecure water supplies.

In the short term, municipalities must devise a plan to reduce the disproportionately high cost of water to these communities. One potential solution is a fee attached to the purchase of fertilizer used to subsidize water costs for communities with contaminated water. Communities with contaminated water could also be added to a nearby water district with access to clean water.

In the longer term, the obvious solution is to substantially reduce synthetic fertilizer and water use in agriculture. Treatment, while effective on a small scale, cannot keep up with the vast quantities of nitrates continually entering groundwater supplies through fertilizer application. Similarly, reduced irrigation on farms, drawn mostly from uncontaminated sources, frees up new sources of drinking water for nearby communities. Lastly, to reach a truly sustainable and equitable system of water distribution, residents of rural communities must be included in the planning and decision-making process as members of local water boards, irrigation districts, and planning commissions to establish and safeguard their right to uncontaminated water.

7 USDA, National Agricultural Statistics Service. 2012. 2012 Census of agriculture, county data. www.agcensus.usda.gov/Publications/2012/Full_Report/Volume_1,_Chapter_2_County_Level/California/st06_2_002_002.pdf

8 USDA Economic Research Service. 2012. County-level data sets. www.ers.usda.gov/data-products/county-level-data-sets/poverty.aspx#Pa8c98972d6c14aaea0543afd59db4088_3_382i74

9,10 United States Census Bureau. State and county QuickFacts, Tulare County. quickfacts.census.gov/qfd/states/06/06107.html

11 California State Water Resources Control Board. Groundwater ambient monitoring and assessment (GAMA). Domestic well project, groundwater quality data report, Tulare County focus area. Table 2: Summary of detections above drinking water standards. www.swrcb.ca.gov/gama/docs/tularesummaryreport.pdf

12 Brown, Patricia Leigh. 2012. The problem is clear: The water is filthy. *New York Times*, November 13, 2012. www.nytimes.com/2012/11/14/us/tainted-water-in-california-farmworker-communities.html?pagewanted=all&r=0

13 Harter, Thomas. 2009. Agricultural impacts on groundwater nitrate. *Southwest Hydrology*, July/August 2009. www.swhydro.arizona.edu/archive/V8_N4/feature2.pdf

14 California State Water Resources Control Board. 2010. Groundwater information sheet. www.waterboards.ca.gov/gama/docs/coc_nitrate.pdf

Appendix 1: Water Cycling Terms

EVAPOTRANSPIRATION

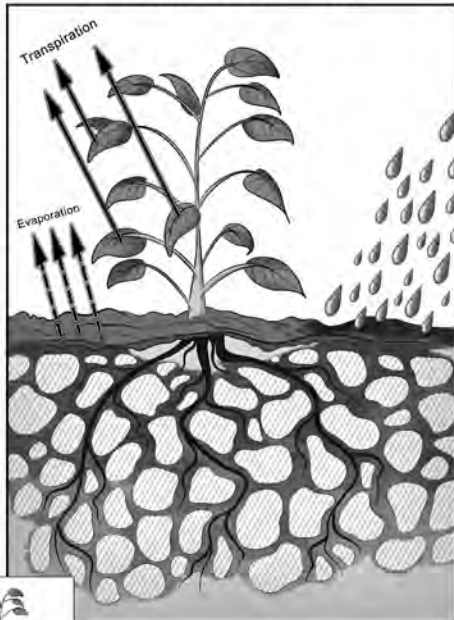

Initial state

Transpiration: water loss from the plant leaves
Evaporation: water loss from the soil surface
Transpiration + Evaporation = Evapotranspiration (ET)

INFILTRATION / PERCOLATION

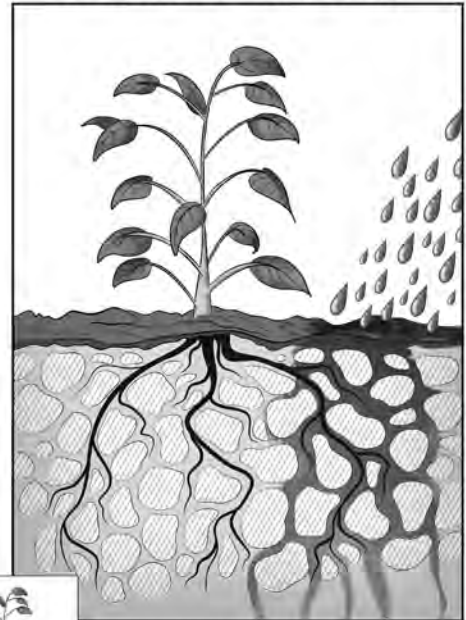

Initial state

Over application of irrigation water can cause leaching of nitrogen and phosphorus from the root zone and can cause contamination of aquifers, streams, ponds, and lakes.

SATURATION

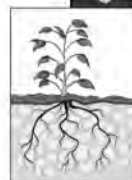
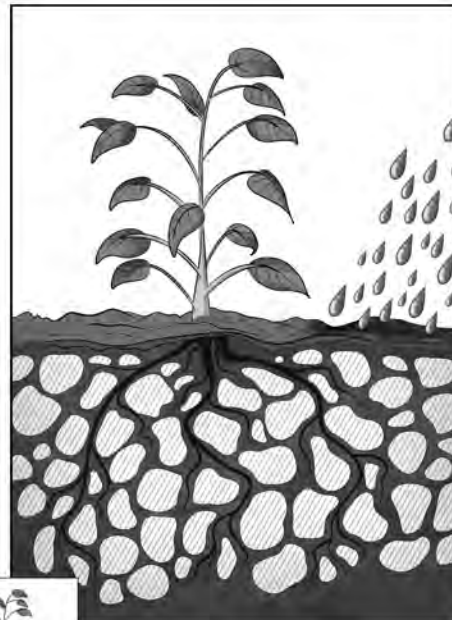

Initial state

Illustrations by José Miguel Mayo

Appendix 1 (cont.): Water Cycling Terms

FIELD CAPACITY

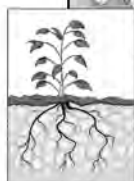
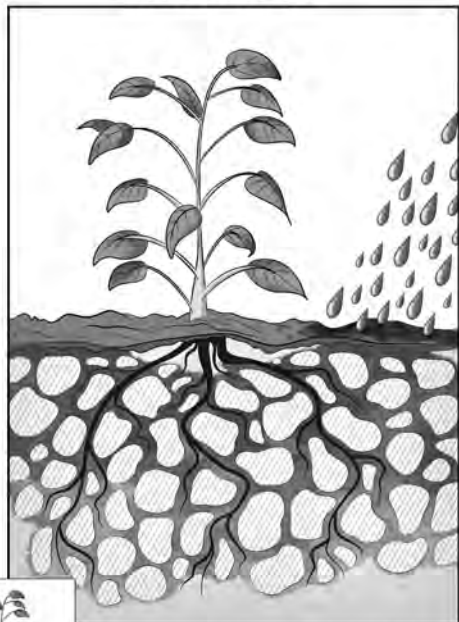

Initial state

Amount of water the soil can hold against the pull of gravity.

PERMANENT WILTING POINT

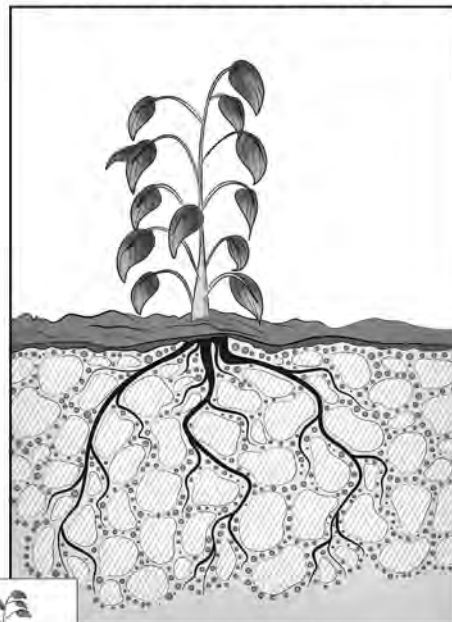

Initial state

Point at which the plant can no longer uptake water held tightly to the surface of the soil particles.

Illustrations by José Miguel Mayo

Appendix 2: Units of Water Measurement

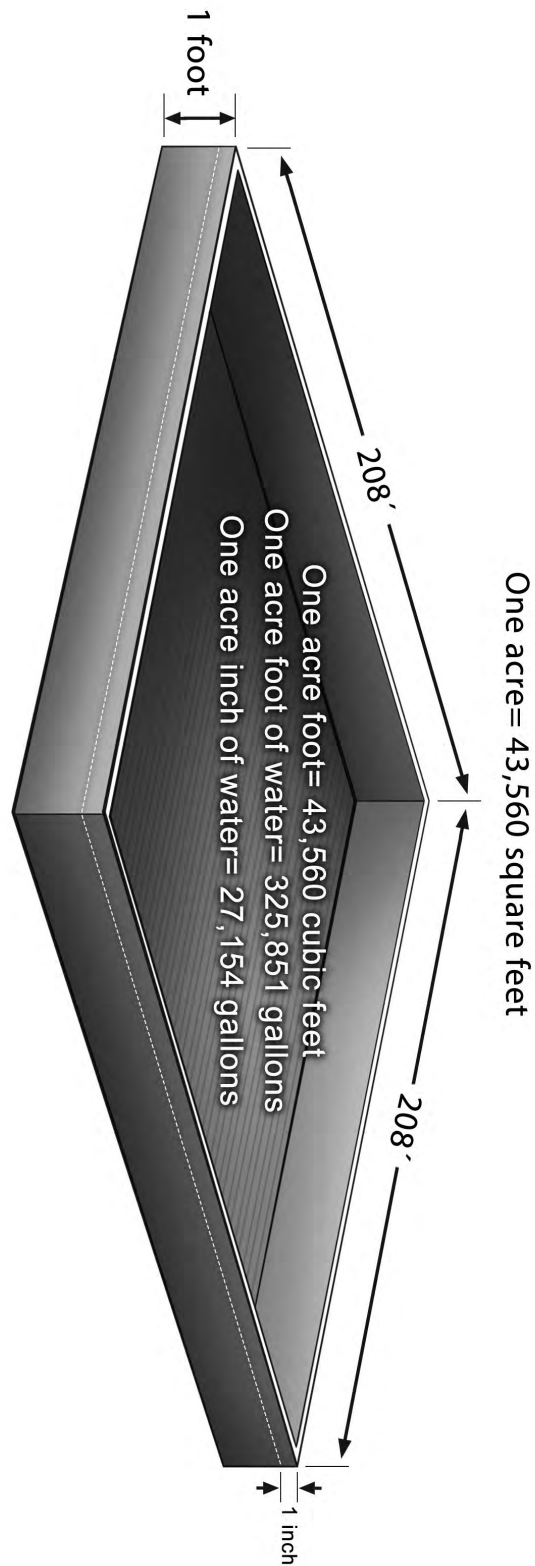

Illustration by José Miguel Mayo

Appendix 3: Calculating Distribution Uniformity (DU)

Distribution uniformity (DU) is defined as how uniformly water is distributed over an area being irrigated, and is expressed as a percentage: the higher the percentage value, the more evenly water is distributed.

You can calculate distribution uniformity by collecting water in sample “catch buckets” or rain gauges laid out in an even grid between irrigation pipes or along the length of a drip line (see diagram). DU can then be determined using the “low quarter DU” method, in which the average of the lowest quarter of the samples collected is divided by the average of all samples to get a percent of distribution: 80% or above is considered an acceptable distribution uniformity.

SPRINKLER UNIFORMITY OF DISTRIBUTION TEST

(Uniformity based on average volume of lowest 25% of catch buckets divided by average of remaining 75%)

(30 x 30- 16 catch buckets)

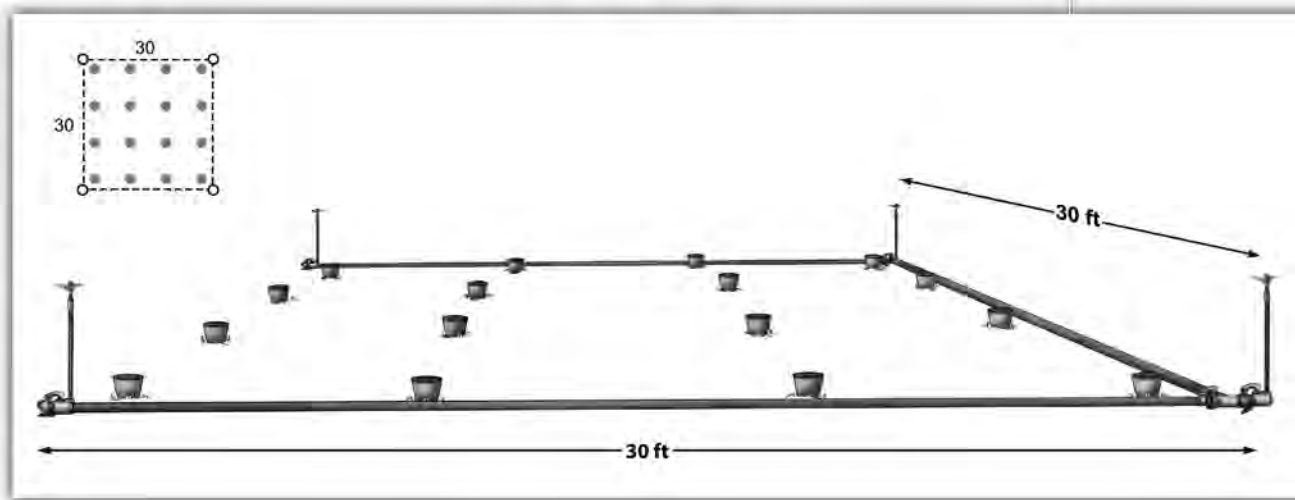

Head	Nozzle	psi	Rotation	Spacing	Duration	% Uniformity
Nelson rotator	7/64"	50	360	30 x 30	5 min	68.40%
Nelson rotator	7/64"	50	180	30 x 30	5 min	43.49%
Plastic impact	Blue	50	180	30 x 30	5 min	70.78%
Brass impact	1/8"	30	360	30 x 30	5 min	56.97%
Brass impact	1/8"	50	360	30 x 30	10 min	69.46%
Brass impact	1/8"	50	360	30 x 30	5 min	66.18%
Brass impact	1/8"	50	180	30 x 30	2.5 min	63.29%
Brass impact	1/8"	45	180	30 x 30	2.5 min	65.22%

Low quarter DU calculation: Average volume of lowest 25% of catch buckets divided by Average volume of all samples collected = Distribution Uniformity (DU)

Illustration by José Miguel Mayo

Appendix 3 (cont.): Calculating Distribution Uniformity (DU)

To calculate DU:

- 1 Lay out an evenly spaced grid of catch buckets or rain gauges between irrigation pipes or along a drip line (see diagram on page I-248); note that if you use the Taylor style rain gauges that measure precipitation/irrigation in inches, you can simultaneously test for application rate as well as uniformity
- 2 Run irrigation for 5 minutes
- 3 Measure and record the volume of water in each catch bucket or rain gauge
- 4 Rank the volume of water collected in each bucket or rain gauge, from lowest to highest
- 5 Calculate the average volume collected in the lowest 25% of catch buckets or rain gauges, and divide that number by the average volume of all the samples collected to get DU (measured as a percentage)

Example:

Average volume of lowest 25% of catch buckets = 4 inches

Average volume of all samples collected = 5 inches

DU = 4 divided by 5 = 80%

A low DU percentage (less than 80%) indicates poor distribution uniformity, i.e., one area of the field or bed is receiving significantly more irrigation water than other areas. Sources of poor uniformity can include malfunctioning or clogged sprinkler heads, differences in nozzle orifice sizes across a field, improper pipe spacing, improper operating pressure (too high or too low), windy conditions, and differences in pressure due to slope.

A similar DU test can be done for drip irrigation systems:

- 1 Once the system is brought up to pressure, collect water for a set amount of time (e.g., 5 minutes) in shallow containers placed beneath emitters, evenly spaced along drip lines at a number of locations in the field. Bury the trays to grade level so that they do not create undulations that might impact distribution uniformity
- 2 Make sure that all the containers are under the emitters for the same length of time
- 3 Measure and record the volume of water in each container
- 4 Use the “low quarter DU” method to calculate distribution uniformity. Note that using a number of containers/data points divisible by four will make the calculations easier.

Drip system uniformity can also be tested by taking pressure measurements using Shrader valves throughout the field. See a presentation of this method at:

www.agwaterquality.org/toms%20presentation%20DU%20in%20Drip%20and%20Sprinkler.pdf

Appendix 4: Estimating Soil Moisture by Feel

SOIL MOISTURE LEVEL (% OF FIELD CAPACITY)	COARSE (SAND)	LIGHT (LOAMY SAND, SANDY LOAM)	MEDIUM (FINE, SANDY LOAM, SILT LOAM)	HEAVY (CLAY LOAM, CLAY)
0–25% No available soil moisture. Plants wilt.	Dry, loose, single grained, flows through fingers. No stain or smear on fingers.	Dry, loose, clods easily crushed and will flow through fingers. No stain or smear on fingers.	Crumbly, dry, powdery, will barely maintain shape. Clods, breaks down easily. May leave slight smear or stain when worked with hands or fingers.	Hard, firm baked, cracked. Usually too stiff or tough to work or ribbon ¹ by squeezing between thumb or forefinger. May leave slight smear or stain.
25–50% Moisture is available, but level is low.	Appears dry; will not retain shape when squeezed in hand.	Appears dry; may tend to make a cast ² when squeezed in hand, but seldom will hold together.	May form a weak ball ² under pressure but will still be crumbly. Color is pale with no obvious moisture.	Pliable, forms a ball; will ribbon but usually breaks or is crumbly. May leave slight stain or smear.
50–75% Moisture is available. Level is moderate to high.	Color is darkened with obvious moisture. Soil may stick together in very weak cast or ball.	Color is darkened with obvious moisture. Soil forms weak ball or cast under pressure. Slight finger stain, but no ribbon when squeezed between thumb and forefinger.	Color is darkened from obvious moisture. Forms a ball. Works easily, clods are soft with mellow feel. Will stain finger and have slick feel when squeezed.	Color is darkened with obvious moisture. Forms good ball. Ribbons easily, has slick feel. Leaves stain on fingers.
75% to field capacity (100%) Soil moisture level following an irrigation.	Appears and feels moist. Color is darkened. May form weak cast or ball. Will leave wet outline or slight smear on hand.	Appears and feels moist. Color is darkened. Forms cast or ball. Will not ribbon, but will show smear or stain and leave wet outline on hand.	Appears and feels moist. Color is darkened. Has a smooth, mellow feel. Forms ball and will ribbon when squeezed. Stains and smears. Leaves wet outline on hand.	Color is darkened. Appears moist; may feel sticky. Ribbons out easily, smears and stains hand, leaves wet outline. Forms good ball.

¹ Ribbon is formed by squeezing and working soil between thumb and forefinger

² Cast or ball is formed by squeezing soil in hand

See also:

USDA, Natural Resources Conservation Service. 1998. Estimating Soil Moisture by Feel and Appearance. Program Aid Number 1619. www.nrcs.usda.gov/wps/portal/nrcs/detail/mt/newsroom/?cid=nrcs144p2_056492

Appendix 4 (cont.): Estimating Soil Moisture By Feel



Using the “squeeze test” to estimate soil moisture

Illustrations by José Miguel Mayo

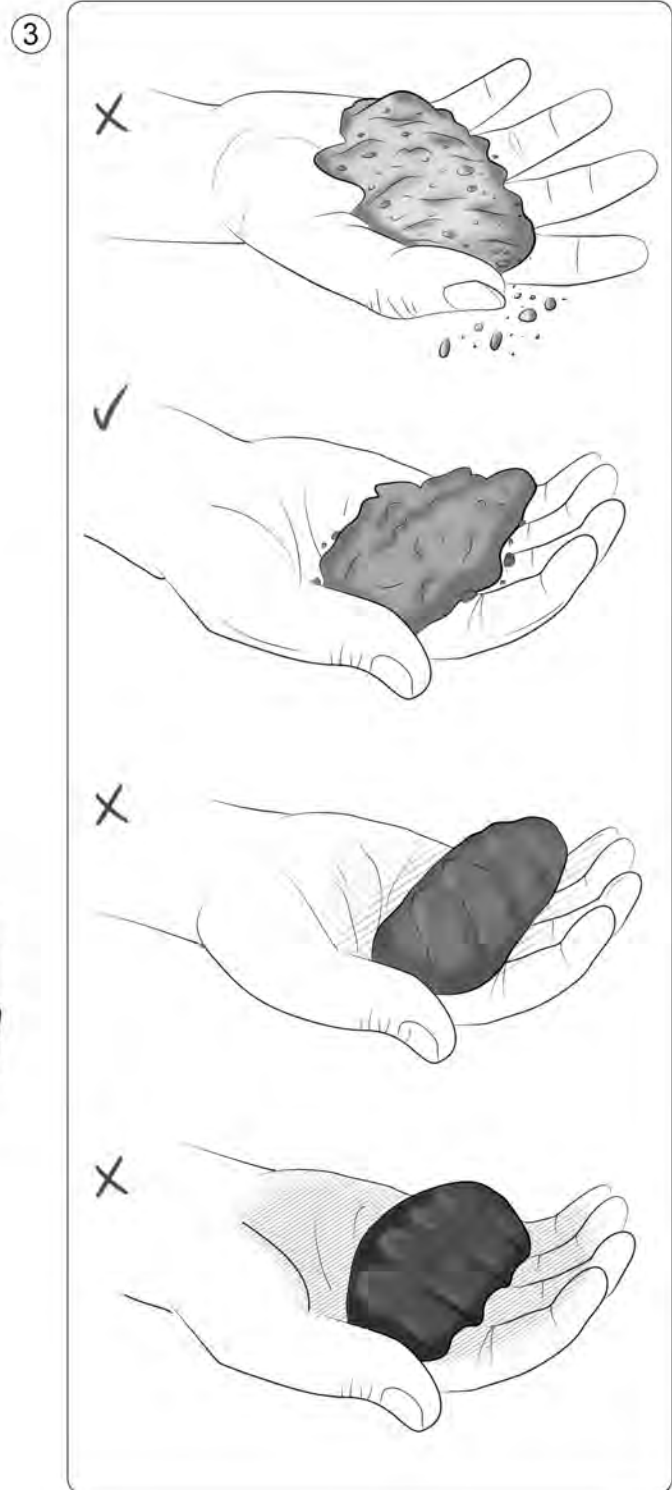

Appendix 5: Critical Periods for Soil Water Stress by Crop

Apples: During spring growth, flowering, fruit set and development

Arugula: During vegetative growth

Basil: Maturity, to prevent stress-induced flowering

Beans: Flowering, seed set, pod development

Beets: Regular water as roots develop

Broccoli: Head development

Brussels Sprouts: Vegetative and sprout development

Cabbage: Head development

Carrots: Early root development, regular water to prevent cracking

Cauliflower: Head development

Cilantro: During vegetative growth

Collards: During vegetative growth

Corn: During crown root development, at pollination and kernel development

Cucumbers: Flowering and fruit development

Eggplant: All stages

Fennel: Bulb development

Kiwifruit: During spring growth, flowering, and fruit set

Leeks: All stages

Lettuce, head: Head development, pre-harvest

Lettuce, leaf: All stages, pre-harvest

Melons: Flowering and fruit set

Onions, garlic, shallots: During bulb enlargement

Parsley: All stages

Parsnips: Early root development

Peas: Flowering, pollination, pod enlargement

Pears: During spring growth, flowering and fruit set

Peppers: All stages, but allow dry-down between waterings

Plums: During spring growth, flowering, fruit set and development

Potatoes: Tuber enlargement, from flower to die-back

Pumpkins: Flowering, fruit set and development

Radishes: All stages

Small grains: During crown root development, heading, flowering

Squashes (summer and winter): Flowering, fruit development

Tomatoes: All stages, but especially flowering and fruiting

Flowers: Bud development through flowering, and pre-harvest

Appendix 6: General Irrigation Rules



During the flowering and fruit set stages of crop development, plants are most sensitive to drought/water stress.



Most crops require irrigation when the soil moisture in the root zone of the plant has decreased to ~50% of field capacity. Use Appendix 4, Estimating Soil Moisture By Feel, to help you determine the moisture content of the soil.



Seed beds containing small-seeded, directly sown crops require light and frequent water applications. Apply water each time 50% of the surface soil has dried down, showing discoloration (see Appendix 6, Garden-Scale Seed Bed Irrigation in Unit 1.4, Transplanting and Direct Seeding).



Seed beds containing large-seeded, directly sown crops require less frequent water applications. Apply water each time the soil at the depth of the seed has dried to 50% of field capacity. Use Appendix 4 to help you determine the moisture content of the soil.

ADDENDA TO THE GENERAL RULES

- 1** *Potatoes:* Phase 1 and phase 4 (the planting and maturation stages) require the full soil moisture fluctuation between 50% and 100% of field capacity. Phase 2 and phase 3 (tuber initiation and enlargement) demand less of a fluctuation, responding favorably to a moisture swing between 75% and 100% of field capacity.
- 2** *Other Solanaceae family crops* (e.g., tomatoes, peppers, eggplant) respond favorably to a full swing between 50% and 100% of field capacity
- 3** *Cut flowers:* Irrigation 24 hours prior to harvest will help assure full turgor pressure at harvest time and increase the vase life of the stems or bouquets
- 4** *Leafy greens:* 50% of field capacity minimum
- 5** *Alliums:* 50% of field capacity minimum
- 6** *Established fresh beans and peas:* 50% of field capacity minimum
- 7** *Celery* responds favorably to a moisture swing between 75%–100% of field capacity
- 8** It is important to *calculate irrigation system uniformity*. This information is critical for accurate determination of irrigation application rates; see Appendix 3: Calculating Distribution Uniformity (DU)
- 9** *For best yield, turgidity and post harvest handling of brassicas, lettuce, leafy greens and carrots* it is advisable to irrigate as close to harvest as possible, especially during warm weather
- 10** *Over application of irrigation water* will increase cost of production, limit deeper rooting of some crops, potentially leach water-soluble nutrients from the root zone, enhance weed pressure, and enhance soilborne and foliar disease pressure
- 11** *Delivery system design* is critical when utilizing well water when the pump delivers water directly to the delivery system

Appendix 7: Irrigation for Various Vegetable Crops



 SHALLOW ROOTS – 6 to 24 inches

 MEDIUM ROOTS – 24 to 40 inches

 DEEP ROOTS – more than 40 inches

Arugula: Frequent shallow water to maintain flavor and succulence and support rapid growth.	 SHALLOW
Asparagus: Water deeply and infrequently. Allow to dry down between watering.	 DEEP
Basil: Somewhat thirsty. Important to water prior to harvest.	 MEDIUM
Beans, fresh: Can drink lots of water because they are fast growing. Once fruit is set, can often “finish” the crop with less or no water to enhance flavor. Vulnerable to disease with overhead water.	 MEDIUM
Beans, dry: Treat as fresh beans until seeds begin to mature, then gradually cease application of water.	 SHALLOW
Beets: Give adequate supply of water as lack thereof during warm weather causes plants to bolt or beet roots to crack and become tough and woody.	 MEDIUM
Broccoli: Commercial growers use 1-1-1/2” per week. Extra water during crown development will add bulk to the harvest.	 SHALLOW
Brussels Sprouts: Not very efficient at water uptake so require evenly moist soil to function at best. 70-80% of the roots are concentrated at top 8-12” of soil.	 SHALLOW
Cabbage: Needs even moisture or heads will crack. Not very efficient at water uptake.	 SHALLOW
Cabbage, Napa: Keep ground moist.	 SHALLOW
Carrots: Need deep watering until later stages of root development, at which time excess water can cause roots to crack. Cracking is also caused by too great a fluctuation between wet and dry.	 MEDIUM
Cauliflower: Keep soil evenly moist.	 SHALLOW
Celeriac: Thirsty like celery, but more tolerant of wet/dry swings.	 SHALLOW
Celery: Thirsty; needs frequent irrigation to get well established. Do not overhead water because susceptible to fungal disease. Heavy feeder.	 SHALLOW
Chard: Likes moist roots, bolts from water stress.	 MEDIUM
Cilantro: Keep moist to forestall bolting.	 SHALLOW
Corn: Adequate moisture is critical from tasseling through kernel formation and harvest. Do not over water dry corn (e.g., popcorn and ornamental) at maturity; let it dry out on stalk.	 SHALLOW
Cucumber: Sensitive to disturbance. Needs consistently moist soil, watered at base. Susceptible to fungal disease spread through wet leaves. Lack of water when fruits are developing will cut down on production.	 SHALLOW TO  MEDIUM
Eggplant: Need sufficient moisture. Will always benefit from supplemental fertility.	 MEDIUM
Fennel: Likes adequate moisture but not demanding.	 MEDIUM

Appendix 7 (cont): Irrigation for Various Vegetable Crops

 SHALLOW ROOTS – 6 to 24 inches
 MEDIUM ROOTS – 24 to 40 inches
 DEEP ROOTS – more than 40 inches

Flowers: Root depth and water needs vary by species. Generally important to supply regular water during bud formation and flowering.

Garlic: Likes steady supply of water. Stop watering several weeks before harvest to reduce succulence and therefore reduce rot during drying.

 SHALLOW

Kale: Average water needs, except during warm weather when more water is required to prevent wilting.

 MEDIUM

Kohlrabi: Must have even moisture to be tender.

 SHALLOW

Leeks: Never let the soil dry out.

 SHALLOW

Lettuce: Water consistently to avoid bitter taste.

 SHALLOW

Musk melons: Like a constant supply of moisture. Susceptible to foliar disease, so avoid overhead watering.

 MEDIUM

Onions: Steady supply of moisture; if too dry, onions get a strong unpleasant flavor. Avoid water on leaves to minimize downy mildew.

 SHALLOW

Parsley: Somewhat thirsty.

 SHALLOW

Parsnips: Water lovers.

 DEEP

Peas: need adequate moisture at flowering and pod enlargement. Avoid water on leaves to minimize mildew.

 MEDIUM

Peppers: Constant and even moisture from flower through fruit. Peppers like to dry down before being watered again. Will always benefit from supplemental fertility.

 MEDIUM

Potatoes: Even moisture. This is especially critical during period of tuber enlargement which begins at blossom. Cut back on water as vines die back, to cure the skins.

 SHALLOW

Pumpkins: Water deep and infrequent.

 DEEP

Radishes: Need adequate moisture – dry soil results in tough, woody radishes, and vulnerability to flea beetles. Moisture swings cause cracking.

 SHALLOW

Rutabaga: Provide even moisture. Roots will become tough as a result of the development of extra xylem cells if always forced to bring water up from a deep soil level.

 DEEP

Salad mix: Water consistently for succulent growth and to avoid bitter taste.

 SHALLOW

Spinach: Keep evenly moist to forestall bolting.

 SHALLOW

Squash, summer: Rapid growth and ongoing fruit production requires frequent deep water.

 MEDIUM

Squash, winter: Do well with deep and infrequent waterings. Avoid overhead water to prevent foliar disease.

 DEEP

Tomatoes: Like to dry down before being watered again. When blossoming begins, keep soil moisture a little bit drier. Imbalances of moisture may lead to blossom end rot and fruit cracking.

 DEEP

Turnips: Roots will become tough as a result of the development of extra xylem cells if always forced to bring water up from a deep soil level.

 MEDIUM

Appendix 8: Soil Probe & Soil Auger

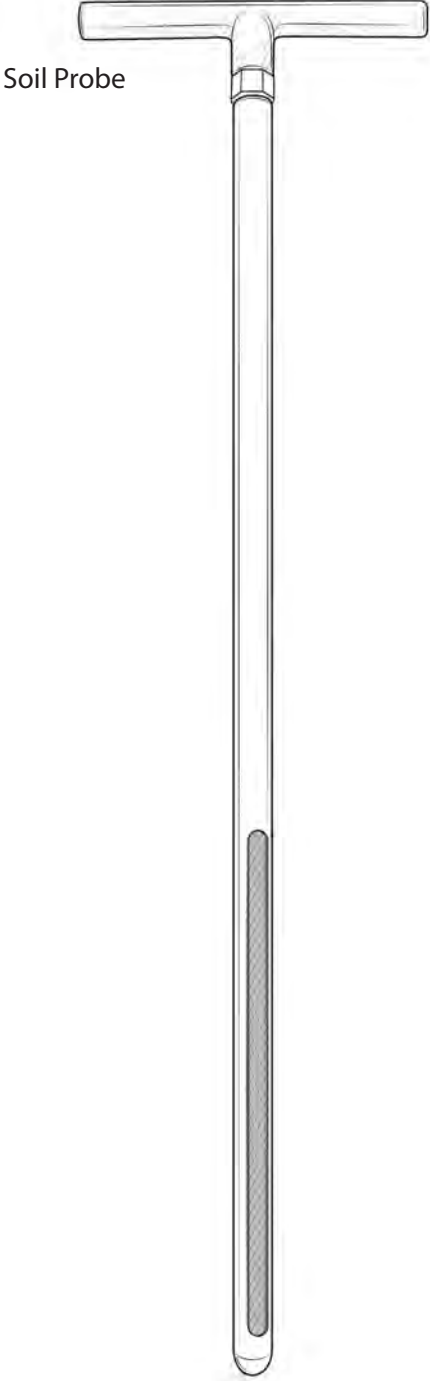

Soil Probe

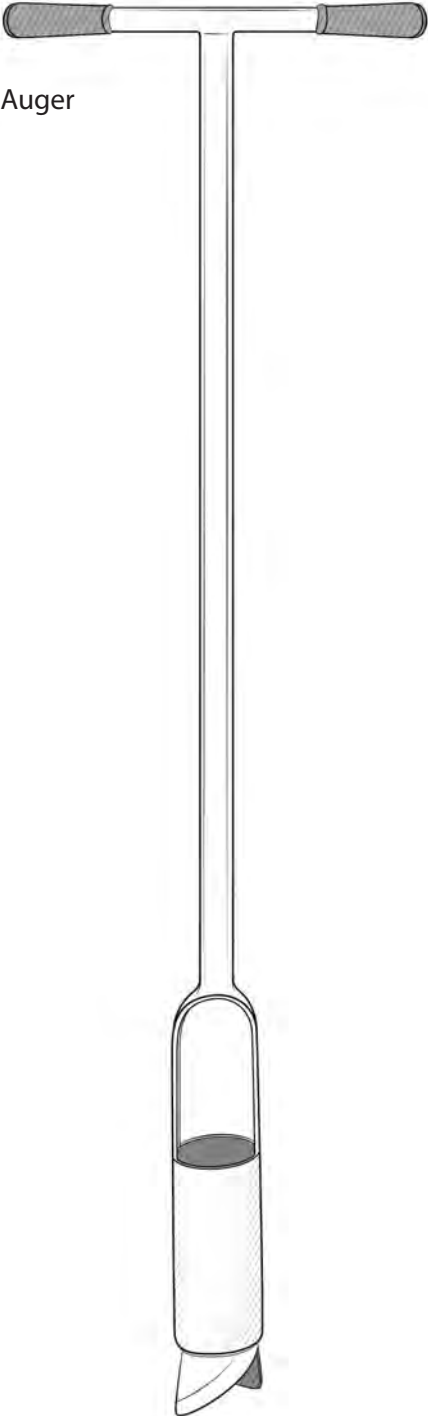

Soil Auger

Illustrations by José Miguel Mayo

Appendix 9: Irrigation System Components

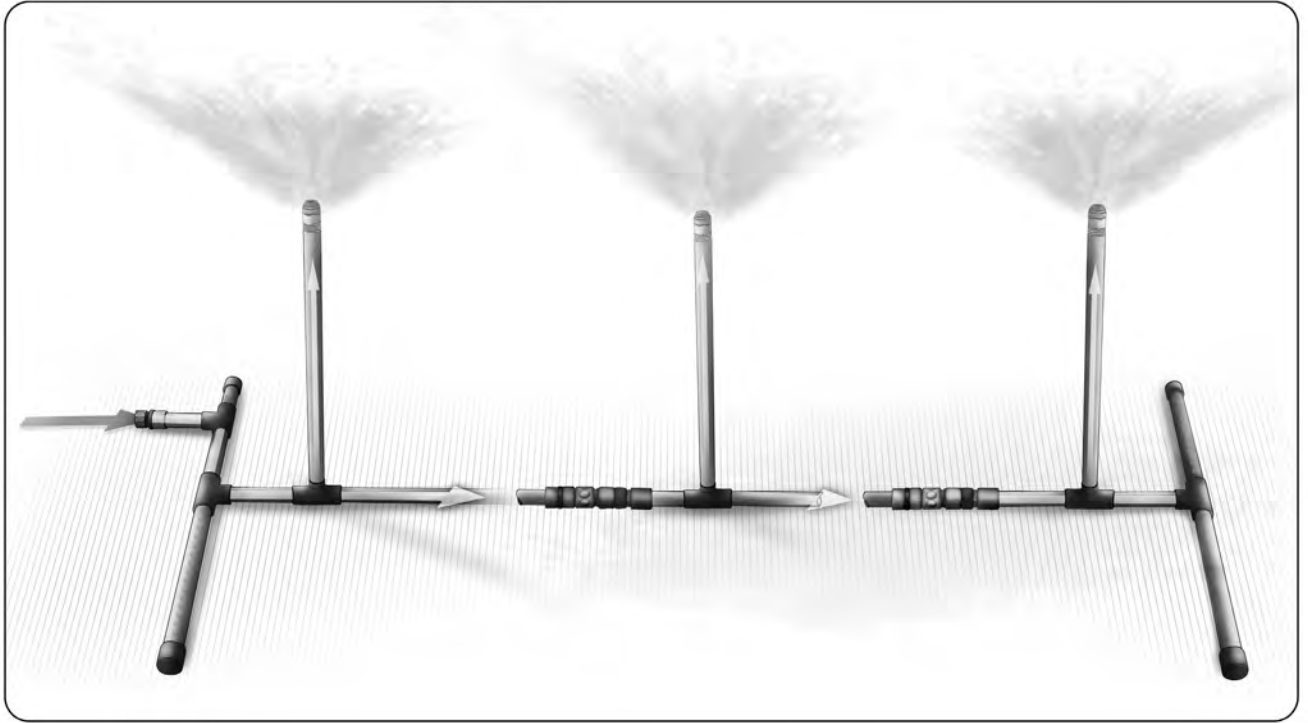

An easy-to-build, portable riser system of PVC and micro sprinklers can be used to irrigate garden beds.

Illustration by José Miguel Mayo

Appendix 9 (cont.): Irrigation System Components

OVERHEAD VOCABULARY

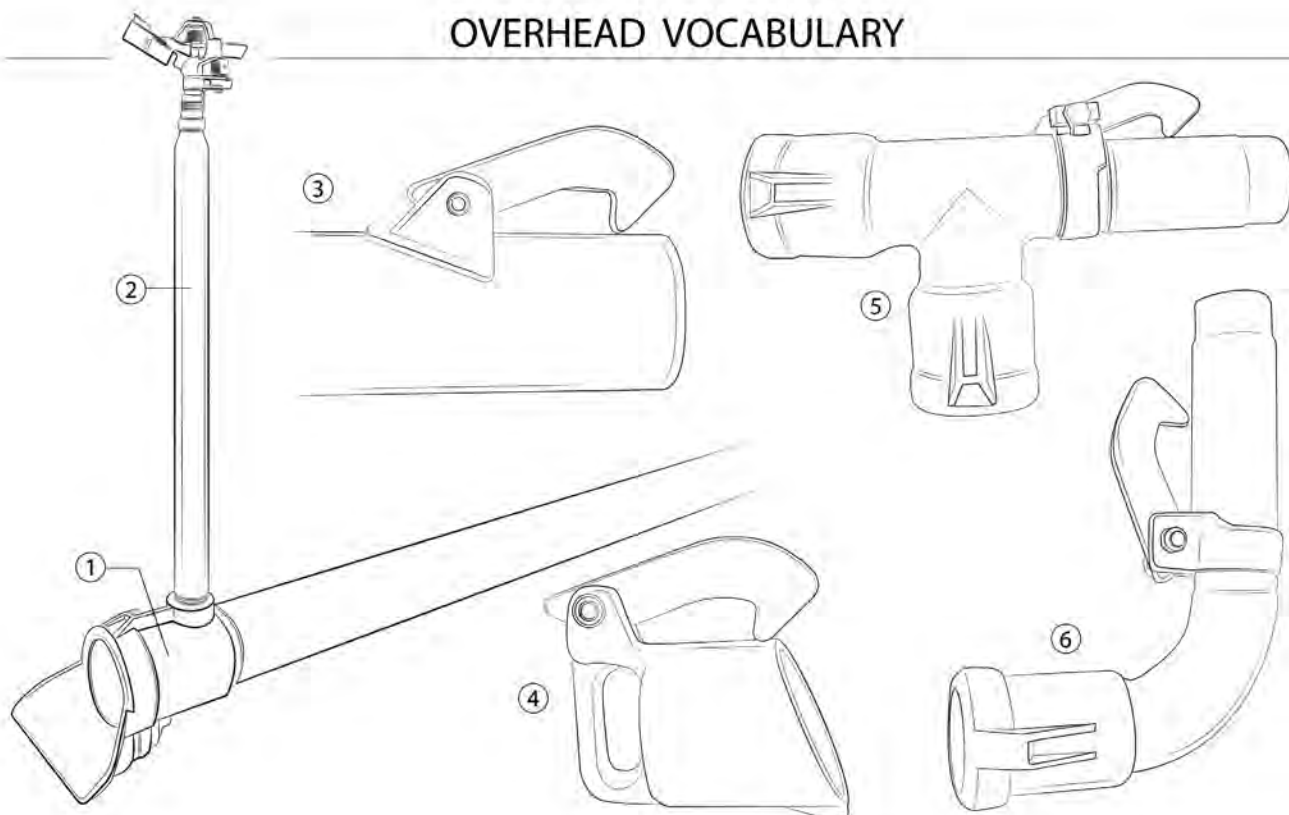

① Overhead aluminum irrigation pipes deliver water to fields. Pipes (also called joints) commonly come in three sizes (2", 3" and 4")

② Impact heads (also known as sprinkler heads) come up from the main pipe and release water over the field. Risers connect impact head to pipes. If necessary, valves can be added to risers to shut off individual sprinklers.

③ Latches connect pipes to each other and to end caps, T's and elbows.

④ End caps seal off the open end of a line of pipe.

⑤ and ⑥: T's and elbows are used to connect pieces of pipe together.

Illustrations by José Miguel Mayo

Appendix 11: Garden Irrigation Schedule

CROP/BED	DATE	TIME	AMOUNT (INCHES OR TIME)	IRRIGATION METHOD	COMMENTS

Appendix 12: Amount of Water Needed to Pre-Irrigate a Dry Soil to Different Depths (Approximate)*

SOIL TYPE	INCHES WATER PER FOOT SOIL DEPTH	INCHES WATER TO REACH 6 FEET DEEP
CLAY	1.4–1.8	8.6–10.8
SILTY CLAY	1.6–1.9	9.6–11.4
SANDY CLAY	1.6–1.9	9.6–11.4
SILTY CLAY LOAM	2.2–2.3	13.0–13.7
CLAY LOAM	2.0–2.2	12.2–13.0
SANDY CLAY LOAM	2.0–2.2	12.2–13.0
SILT-LOAM	1.8–2.0	10.8–12.2
LOAM	1.7–1.9	10.1–11.4
VERY FINE SANDY LOAM	1.7–1.9	10.1–11.4
SANDY LOAM	1.1–1.3	6.5–7.9
LOAMY VERY FINE SAND	1.1–1.3	6.5–7.9
LOAMY FINE SAND	1.0–1.2	5.8–7.2
LOAMY SAND	0.7–1.0	4.3–5.8
VERY FINE SAND	0.7–1.0	4.3–5.8
FINE SAND	0.7–1.0	4.3–5.8
SAND	0.7–1.0	4.3–5.8
COARSE SAND AND GRAVEL	0.4–0.7	2.2–4.3

* Based on available water holding capacity; plants have dried soil to permanent wilting point, 15 ATM. Assumes the soil is uniform throughout irrigation depth.

Appendix 13: Sample Sprinkler & Drip Tape Application Rate Calculations

Sample sprinkler application rate calculation

You determine your sprinkler risers put out **3.5 gpm (gallons per minute)** at 60 psi

30 × 30 spacing = 64 risers per acre

64 risers × 3.5 gpm = 227.5 gpm

227.5 gpm × 60 = 13,650 gph (gallons per hour)

There are 27,154 gallons of water per acre inch

27,154 divided by 2 = 13,577 gallons

So, 13,650 gallons per hour = approximately .5 inch application rate per hour

If your application uniformity is 80% then your application rate is closer to .4 inches per hour (.5 × 80%)

Sample drip application rate calculation

Flow rate: .75 gpm per 100 feet @ 8 psi (from label)

Bed spacing 2 feet

Bed length 100 feet

218 beds per acre

218 beds × 100 feet = 21,800 bed feet per acre

Total bed feet divided by 100 = 218 100-foot sections per acre

218 sections × .75 gpm (per 100 feet) = 163.5 gpm

163.5 gpm × 60 minutes per hour = 9,810 gph

9,810 gph = 2.76 hours to apply one acre inch

27,154 gallons per acre inch divided by 9,810 gph = 2.76 hours

Selecting and Using Cover Crops

Introduction	265
Lecture 1: Definition, Benefits, and Challenges of Cover Crops	267
Lecture 2: Cover Crop Selection, Planting, and Care; Special Cases; Estimating N Contribution	271
Demonstration: How to Estimate the Nitrogen Contribution of a Cover Crop	275
Hands-On Exercise: Calibrating a Seed Drill	277
Assessment Questions and Key	279
Resources	281
Supplements	
1. Cover Cropping and Other Agroecological Practices Benefit Crops in the Face of Climate Change	285
2. Cover Crop Selection, Planting Tips, Tools and Techniques for California Central Coast Small-Scale Organic Vegetable Farms	287
Appendices	
1. Cover Crop Seeding Rate and Depth Chart	293
2. Carbon to Nitrogen Ratios and Percent Nitrogen of Various Cover Crops	294

Introduction: Selecting & Using Cover Crops

OVERVIEW

Cover crops can be a key soil health and nutrient management tool for growers, and can have important implications for pest and disease management. This unit introduces students to the roles and selection of cover crops for organic farming and gardening.

Two lectures address the influence of cover crops on the physical and chemical properties of soil, the role cover crops can play in pest management, the benefits and challenges of using cover crops, and the factors to consider when selecting a cover crop for a farm or garden. The in-field demonstration shows students how to estimate the nitrogen contribution of a cover crop. In the hands-on exercise, students will determine the amount of cover crop seed being discharged by a seed drill and learn how to calibrate the drill. Supplemental topics address the role of cover crops and climate change, and offer examples of integrating cover crops into a small-scale organic vegetable farm on California's Central Coast.

MODES OF INSTRUCTION

- > LECTURES (2 LECTURES, 1 HOUR EACH)
 - Lecture 1 examines the role and definition of cover crops, and the benefits and challenges of using various cover crops.
 - Lecture 2 addresses cover crop selection, planting and care; special cases; how to plant; and nitrogen contribution calculations.
- > DEMONSTRATION: HOW TO ESTIMATE THE NITROGEN CONTRIBUTION FROM A COVER CROP (1 HOUR)
 - In this in-field exercise the instructor demonstrates how to collect and dry a cover crop sample and use it to estimate the amount of nitrogen that will available to the crop that season.
- > HANDS-ON EXERCISE: SEED DRILL CALIBRATION (1 HOUR)
 - This in-field exercise takes students through the steps of calibrating the amount of seed being discharged by a seed drill.
- > ASSESSMENT QUESTIONS: (0.5 HOUR)
 - Assessment questions reinforce key unit concepts and skills.
- > VIDEO
 - See casfs.ucsc.edu/about/publications, and click on Teaching Organic Farming & Gardening.

LEARNING OBJECTIVES

CONCEPTS

- The influence of cover crops on the physical and chemical properties of soils and the productivity of crops grown in those soils
- The roles cover crops can play in pest and disease management
- The benefits and challenges to consider when selecting a cover crop for farm or garden use
- The disease triangle: Interactions among environment, pathogen, and plant
- The key steps involved in cover crop planting and incorporation

SKILLS

- How to access cover crop information
- How to evaluate cover crops for specific applications
- How to estimate nitrogen contributions of cover crops

Lecture 1: Definition, Benefits, & Challenges of Cover Crops

Pre-Assessment Questions

1. What benefits can be derived from the regular use of cover crops in a farming system?
2. What role do cover crops play in the management of soil fertility in organic farms and gardens?
3. How can cover crops be used to ensure adequate soil nutrient levels?
4. How can cover crops improve the physical and chemical properties of agricultural soils?
5. What roles can cover crops play in pest management?
6. What are some of the challenges to using cover crops?

A. Why Use Cover Crops?

1. The role of cover crops in organic farming systems

Cover crops are one of the primary fertility and soil management tools available to organic growers. They are crops grown primarily for soil or ecosystem improvement rather than cash (although some can have secondary uses as fodder), and are most often planted following fall harvest and turned in to decompose prior to spring planting (although this varies depending on climate). Some fast-growing cover crops can also be grown during the cropping season to rebuild nutrient levels and soil organic matter.

Cover crops can provide a variety of services, from increased nitrogen (N) and organic matter input, to soil protection, to weed and disease suppression. However, they can also have negative consequences if they are managed incorrectly or inappropriate species are selected.

2. Cover crop, "green manure," and "catch crop" defined

Although "cover crop" is the term most widely used for non-cash crops filling any one of several key roles, "cover crop," "green manure," and "catch crop" technically refer to different primary functions of the crops

- a) Cover crop: Mainly used to prevent soil erosion by covering soil with living plants
- b) Green manure: Crop mainly grown to be turned under for soil improvement
- c) Catch crop: Used to "catch" nutrients left after harvest of a cash crop and prevent nutrient leaching

Note that these are not mutually exclusive functions. For example, a fall-planted cereal + legume crop that is incorporated the following spring can serve as a cover crop, green manure, and catch crop, and generally will be referred to simply as a cover crop. However, different species and mixes may perform one function better than another.

B. Benefits of Cover Crops

Cover crops provide a range of benefits: Alone or in combination, different cover crops can increase soil fertility, boost soil organic matter, limit weed growth, and minimize nutrient leaching and erosion, and more. When selecting cover crops, keep in mind the types of benefits they provide and the needs of your cropping system:

1. *Provide nitrogen.* Here the best choice would be a legume that is well adapted to your area. Rhizobia bacteria work in symbiosis with legumes to fix N_2 from the atmosphere, and the N becomes available after the plant is incorporated into the soil. It is important that sufficient rhizobia bacteria are present in the soil to give good root nodule formation, and hence N_2 fixation. If it is the first time a legume cover crop has been grown in a field it

is recommended that you purchase the appropriate rhizobium inoculant for the species being planted. Some seed also comes pre-inoculated. A rough guide to estimating the N contribution from a cover crop is shown in Lecture 2 (excerpted from *Managing Cover Crops Profitably, 3rd Edition*, published by the Sustainable Agriculture Network). A hands-on exercise will help you learn how to perform this estimate in a fall-planted cover crop.

2. *Increase soil organic matter (SOM) and improve nutrient availability by increasing soil biological activity.* To build SOM you would look for a high biomass-producing cover crop. Possible options include non-legumes such as annual rye grass, cereal rye, triticale, or sorghum/sudan grass. High-biomass legumes such as subterranean clover or vetch also provide both SOM and N input, as would a mix of cereals and legumes. A cover crop that can grow rapidly in a short time window is also effective: for example, a fast-developing crop of buckwheat grown after early summer harvest that is turned in to break down before late summer planting can boost SOM between crops (see Appendix 1: Cover Crop Seeding Rate & Depth Chart).
3. *Scavenge nutrients left in the soil after the cash crop and prevent loss by leaching.* To maximize nutrient scavenging the cover crop should have an extensive root system that develops quickly after planting. Non-legumes such as oats, cereal rye, triticale, rapeseed, annual rye grass, and mustards (e.g., c.v. Ida Gold, Kodiak and Pacific Gold) work well.
4. *Prevent soil erosion.* Here the key is to choose a species that rapidly covers the soil surface. Many of the species that are good nutrient scavengers also provide excellent ground cover. However, while annual rye grass is a good nutrient scavenger, it has fine leaves and is slow to cover the soil surface. Triticale, however, has a prostrate early growth morphology, allowing it to cover the surface quickly.
5. *Improve soil structure.* Increasing SOM is the key to improving soil structure, so high-biomass species are appropriate here, too. It may be beneficial to include a non-legume to provide organic material that breaks down more slowly after incorporation than a legume alone (the lower C:N content of legumes causes them to break down rapidly in the soil).
6. *Improve drainage.* Some deep-rooted species can help to break through compacted layers in the soil and improve drainage. The roots of soil-penetrating cover crops also create channels through which water can move as the root systems decompose after death or incorporation; e.g., growers in some systems use “tillage (forage) radishes” to break up compaction (see *Mixtures and cocktails: Soil is meant to be covered* in Resources). In addition, many grass species with extensive, fibrous root systems add large quantities of organic matter to the soil by sloughing off roots. Such organic matter additions stimulate biological activity and the formation of soil aggregates, which improve drainage. Such grasses include annual rye, perennial rye, and oats.
7. *Protect water quality.* Protecting water quality includes reducing surface run-off of soil particles and the nutrients bound to them as well as reducing leaching of nutrients through the soil profile. Sediment and nutrients reduce water quality in fresh and marine surface waters and nutrient concentrations can build up in groundwater or aquifers. Species that prevent soil erosion and scavenge nutrients during periods of high rainfall, either alone or in a mix, can help minimize these losses. It is also important to avoid turning in high N cover crops during periods when N is vulnerable to leaching, e.g., when there is little or no crop cover and high rainfall.
8. *Provide mulch to conserve soil moisture and/or suppress weeds.* A combination of high above-ground biomass and moderate or high C:N ratio residues is desirable (note: 24–30:1 is an ideal C:N ratio; 40:1 is moderate and 80:1 is high). Most legume residues with their high N content will decompose too rapidly to be effective. However, note that mulching to conserve moisture is rarely of use in Mediterranean climates where there is little or no summer rainfall.

9. *Provide habitat for beneficial insects and spiders.* Annual cover crops have variable effects in providing habitat for beneficial invertebrates. The effect depends on the particular crop, cover crop, and pest, as well as other factors specific to the cropping system. Winter cover crops in California generally have little overlap with summer crops, so may not be good hosts for beneficials that would need to survive until the summer crop is established.

Cover crops can provide good habitat for beneficials in perennial systems such as orchards and vineyards, especially when species with food sources such as flowers or extrafloral nectaries (e.g., vetch) are used. Note that to achieve this benefit, you need to consider cover crops as part of a whole-farm plan. While cover crops will attract beneficials, if they have no place to move (e.g., hedgerow or surrounding natural areas) when the cover crops are mown and incorporated, you will lose them and their predation or parasitoid functions.

10. *Suppress weeds.* Cover crops can reduce weed populations either by outcompeting weeds by earlier or more vigorous growth and dense canopy cover, or by releasing allelopathic compounds that inhibit weed seed germination and seedling growth. However, the ability of cover crops to do so depends on factors such as seeding rate, choice of cover crop, row spacing, early irrigation, planting date, planting method, and use of cultivation during the cover crop growing season. Cover crops that may help with weed suppression include cereal rye, triticale, sorghum/sudan, mustard, and high biomass or allelopathic legumes. A densely-seeded mix of cover crops can also work, providing the canopy closes quickly.
11. *Suppress soil borne pests and diseases.* Certain cover crops can suppress particular disease or pest organisms. For example, cereal rye, sorghum/sudan, selected rapeseed varieties (e.g., c.v. Humus), and white mustard are known to suppress root knot nematodes and soil-borne diseases such as rhizoctonia and verticillium wilt.

C. Challenges of Cover Crops

Despite their positive attributes, incorporating cover crops into your cropping system can also present challenges, including delaying planting and the financial outlay associated with using cover crops. Impacts can include:

1. *Soil moisture depletion.* Vigorous cover crops that grow late into spring may deplete part of the soil moisture that later crops would use. This depends on the cover crop's maturity and seeding rate, as denser stands have greater water use, as well as the cover crop species. Some deep-rooted or rapidly-growing cover crops may have greater water demands.
2. *Rates of mineralization of nutrients for the subsequent crop.* Winter cover crops are used in part for their ability to scavenge nutrients, particularly N, which are then maintained in their biomass during the rainy season. Whether the cover crop is grown in winter or summer, it takes up and thus immobilizes nutrients, which then need to be mineralized for the subsequent crop. This process can be particularly slow for crops with high C:N ratios. At the same time, a long delay between cover crop incorporation and planting of the following crop can lead to loss by leaching or denitrification or to immobilization of fractions of the N by soil microbes, leaving less N available for the crop.
3. *Delayed planting.* Wet springs can delay the timing of cover crop incorporation as a grower waits until the soil is adequately dried down to drive equipment over and through it, avoiding compaction. Waiting the several weeks needed for the cover crop to be mowed and the residue to dry before incorporation can delay crop planting even further.
4. *Increased weed populations.* As described above, many factors determine the ability of cover crops to suppress weeds. A mismanaged cover crop actually can exacerbate weed problems or the crop can become a weed itself if allowed to produce viable or hard seed or other propagules. Growers might consider avoiding the use of the same cover crop every year, particularly if using a single species, to discourage the build up of populations of weeds that are most competitive with that species.

5. *Increased insect pest and disease pressure.* While some cover crops may help decrease pest and disease pressure, others may exacerbate such problems. For example, many legumes are excellent hosts for nematodes, allowing nematode populations to increase rapidly in the soil unless the cover crop is incorporated before the nematodes complete their life cycle. However, if the timing is correct the legume may actually reduce nematode populations by stimulating the nematodes' emergence and then killing them when the crop is incorporated, with the cover crop acting as a kind of trap crop in this way.

Some cover crops (including phacelia, Austrian pea, and vetch) are hosts to the pathogen *Sclerotinia minor* and can have adverse effects on lettuce crops. Fava beans can be affected by Impatiens necrotic spot virus, which can then negatively affect lettuce and radicchio. See *Cover Cropping for Vegetable Production: A Grower's Handbook* (listed in Resources) for a more detailed discussion of current known cover crops and their positive and negative relationships with pathogens.

6. *High percent of cereal biomass.* Even where legumes make up 90% of a legume/cereal blend, you often end up with more cereal biomass than legume biomass. This can be a result of dry weather conditions, which favor the cereals, and soil fertility, where higher fertility and residual nitrogen can favor cereal growth. Thus, getting a significant benefit from the higher-priced legume component can be a challenge.
7. *Financial outlay.* Cover crop production costs vary significantly depending on many factors, including seed selection and seeding rate, duration of the cover crop, and methods of planting and incorporation. Production costs include:
- a) Seed purchase
 - b) Pre-plant land preparation (discing/ripping)
 - c) Planting
 - d) Irrigation (if necessary)
 - e) Termination (mowing and incorporation). Depending on the amount of biomass produced, soil incorporation and seedbed preparation following cover cropping can be a significant cost in terms of the labor and equipment involved.
 - f) Revenue lost while land is out of production
- N contribution from legume cover crops can offset some of the costs of cover crop production. Other benefits, such as improvements in overall soil fertility, tilth, aeration, and water infiltration, are more difficult to quantify, making it difficult to calculate a cost/benefit analysis.

Lecture 2: Cover Crop Selection, Planting, & Care; Special Cases; Estimating N Contribution

Pre-Assessment Questions

1. What are some examples of cool and warm weather cover crop species?
2. What factors must be considered when determining when to plant and incorporate a cover crop?
3. What are some of the techniques for managing weeds in cover crops?
4. What are some of the key pieces of equipment needed to plant and incorporate a cover crop most effectively?
5. How does use of cover crops differ in row crops compared to perennial systems such as orchards and vineyards?

A. Identifying the Cover Crop Planting Niche

1. When and where can the cover crop fit in your crop rotation? What are the climatic and soil conditions at that time? Answering these two questions can help you select the best cover crops for your system.
 - a) Defining when and where the cover crop fits in your crop rotation:

Timing your field operations to avoid interfering with cash crop production is critical. Determine when your field operations and labor needs are low and resources are available for cover crop management. Once the opportunity for cover crop growth and incorporation is identified, then the species selection will depend on the climatic and soil conditions during that window, as well as the goals you're trying to achieve with the cover crop (see Lecture 1, A). Use the publications and websites in the Resources section to determine which cover crops will do well in those conditions.
2. Examples of cool weather and warm weather cover crops (see also *Cover Cropping for Vegetable Production: A Grower's Handbook* for discussion of common cover crops by region in California)
 - a) Winter cover crops: Most cover crops are planted in the fall to provide cover over the winter months. Examples include: vetches, bell beans (a variety of fava beans), peas, annual and perennial clovers, rape seed and oilseed radish, mustards, and grasses such as oats, annual and perennial rye grass, or barley.
 - b) Summer cover crops: When temperatures are high during the summer and if water is available, fast-growing species such as sorghum/Sudan grass and annual buckwheat can provide a good biomass return in a short period

B. Additional Considerations When Selecting Cover Crops

1. Consider the characteristics you don't want as well as those you do. It is rare that the "perfect" cover crop will exist, so you will need to make trade-offs amongst your goals and the climate conditions during the cover-cropping window.
2. Consider the cost and availability of seed
3. Consider the number and types of field operations required for the different cover cropping options to make a sound economic assessment of the alternatives

C. How to Plant a Cover Crop (see also Supplement 2, Cover Crop Selection, Planting Tips, Tools and Techniques for Central Coast Small-Scale Organic Vegetable Farms)

1. Soil preparation prior to cover crop planting
 - a) Soil preparation and timing are critical in order to provide good soil tilth and drainage for a strong, weed-competitive cover crop stand
 - i. Avoid working overly wet soil
 - ii. Ensure adequate soil particle size, especially for small-seeded crops (mustards, legume mixes) to facilitate shallow planting, good water filtration, and adequate germination
 - b) Soil preparation depends in part on the preceding cash crop
 - i. Following low-residue crops (e.g., summer squash), only flail mowing and a single pass with an offset disc and ring roller may be needed
 - ii. Following high-residue crops on beds (e.g., sweet corn), preparation may require flail mowing and multiple passes with offset disc and ring roller to knock down beds and incorporate residue
 - iii. Following overwintered, intensively managed crops (e.g., strawberries), preparation may require multiple passes with an offset disc and ring roller to knock down the beds followed by chiseling or ripping to break up deep furrow compaction created by harvest foot traffic and tractor tires. Multiple passes with an offset disc and ring roller may be needed to break up clods brought to the surface during chiseling and ripping.
 - c) If using a tractor-mounted rototiller to prepare ground for cover crops, limit use to a single pass at appropriate soil moisture (not too wet or dry) to minimize soil aggregate dispersal and soil compaction
2. How to plant: Seed drills, broadcast, drill calibration exercise (see Hands-On Exercise)
 - a) Seed/grain drills (either no-till or conventional) are the best option for planting cover crops
 - i. Seed-line openers facilitate planting into high-residue situations
 - ii. Press wheels on some seed drills facilitate planting to moisture
 - iii. Adjustable seed drop openers allow the operator to set seeding rate
 - iv. Drop tubes must be continually monitored for clogging
 - b) Broadcast seeding
 - i. Plant seed using tractor-mounted, 3-point broadcaster (less expensive than seed drill)
 - ii. Requires secondary tillage to improve seed-soil contact and ensure adequate germination, minimize the number of seeds exposed on the surface: disc, springtooth harrow, preferably used with a ring roller or drag bar to improve soil surface uniformity
 - iii. Numerous passes with seed opening set smaller than anticipated helps ensure a uniform seed application
 - iv. On small acreages (5 acres or fewer), multiple passes with hand-cranked broadcast seeders will ensure uniform seed application
 - c) High-density planter
Tractor-mounted, 3-point high density planter (e.g., those used for salad mix planting) are well suited for planting cover crops on beds free of residue
3. Managing the cover crop to compete with weeds
 - a) Optimize seeding density and plant seed uniformly

- b) In fall, time planting to take advantage of soil warmth and ensure strong germination; cool soils will reduce germination and favor winter weeds
 - c) Select cover crops with allelopathic properties (e.g., mustards, cereal rye) that will reduce weed pressure
 - d) Drill cover crop seed into ground where a flush of weeds (due to irrigation or early rain) has been lightly tilled at the time of weed emergence; plant cover crop seed to residual moisture.
 - e) Till field where weeds are emerging using a quick pass with a rotary hoe or tine weeder as cover crop seed emerges (blind cultivation); depends on timing of weed and cover crop emergence
4. Cover crop incorporation
- a) Timing of cover crop incorporation linked to current and predicted weather, and degree of moisture in the field. Test soil moisture often to determine correct timing.
 - b) Test moisture using “feel” method (see Appendix 1, Judging Soil Moisture by Feel, in Unit 1.5, Irrigation–Principles and Practices). Moisture level is correct when medium to heavy soils form a ball that can be easily broken apart. If soil “ribbons” when squeezed it is too wet to work.
 - c) Once correct soil moisture is reached, flail mow cover crop if volume is high and if cover crop is high in C and lignin
 - d) Mix cover crop residue with soil to facilitate breakdown and bed formation. A mechanical spader is ideal for cover crop incorporation, but expensive.
 - e) Heavy offset wheel disc is most commonly used for incorporation. Adequate incorporation may require several passes; chiseling after several passes will facilitate the disc’s ability to turn soil and will break up compaction caused by the disc.

D. Special Cases

1. Orchards and vineyards
 - a) Annual or perennial cover crops can be used in orchards and vineyards. Perennial cover crops provide the benefit of year-round cover, but they also need management (particularly mowing) to control weeds and pests, provide wildlife habitat, and prepare for harvest.
 - b) In California, native cover crops (e.g., perennial bunch grasses) may provide cover without increasing water demand
2. Garden scale
 - a) Cover crops can be used effectively on a garden or small orchard scale. Fall- and winter-grown cover crops can either be chopped and incorporated to break down prior to bed formation and planting, or skimmed and used as a compost ingredient.
 - b) Note that it’s important to incorporate compost where cover crops are harvested in order to replenish organic matter and nutrients

E. How to Roughly Estimate N Contribution from a Cover Crop

Most growers do not regularly estimate the total N contribution from cover crops, relying instead on general estimates from sources such as Extension or USDA field stations. However, knowing where the values come from and how you could obtain them yourself can give you an overall deeper understanding of N management in cover crops. Doing an estimate can also help you understand how different cover crops or different parts of your farm are performing in terms of N contributions. See the demonstration, How to Estimate the N Contribution from a Cover Crop (page 275) for details.

Demonstration: How to Estimate the Nitrogen Contribution of a Cover Crop

for the instructor

OVERVIEW

Through this hand-on field demonstration and discussion, students will learn how to estimate the nitrogen contribution of a cover crop for nutrient budgeting purposes. (See Unit 1.11: Reading and Interpreting Soil Test Reports for more on nutrient budgeting.)

PREPARATION AND MATERIALS

1. If possible, students should have received the lecture portion of this unit covering the biology and functions of cover crops in agricultural systems.
2. Necessary tools and equipment: greenhouse or oven (for drying cover crops), clippers, measuring tape/stick or measuring frame, scale.
3. A mature stand of actively growing cover crops.
4. Demonstrate procedure and then assign each small group the tasks of cutting, drying, weighing, and calculating the nitrogen contribution of the cover crops (in total N lb/ac).

PREPARATION TIME

1 hour

DEMONSTRATION AND DISCUSSION TIME

(2) 2 hour periods

DEMONSTRATION OUTLINE

A. Discuss and demonstrate the collection and calculation of the above-ground weight for a given area of cover crop

1. Demonstrate taking a number of samples from the field: how to use a yardstick or frame to measure area to be sampled, and how to clip the cover crops at the ground level
2. Demonstrate and discuss techniques for sun drying the fresh cover crop material in the greenhouse or in the oven (150°F) until “crunchy” or brittle

3. After drying material, demonstrate how to calculate the dry weight produced in pounds/acre (lbs/ac) as follows:

a) Dry weight produced in pounds/acre (lbs/ac) as follows:
Dry wt (lb/ac) = $\frac{\text{weight of samples}}{\# \text{ of sq. ft. sampled}} \times 43,560 \text{ square feet}$

b) Multiply dry weight by the % N content of the biomass (see below) to give total N in cover crop in lbs/ac:
Total N (lb/ac) = $\frac{\text{dry weight}}{100} \times \%N$

Typical % N contents for cover crop types

Before flowering:

Annual legumes: 3.5–4%

Perennial legumes: 2.5–3%

Grasses, brassicas: 2–3%

When flowering:

Annual legumes: 3–3.5%

Perennial legumes: 2–2.5%

Grasses, brassicas: 1.5–2.5%

Note: To estimate how much of the N will be available to the crop that season:

If conventionally tilled, divide total N by 2

If left on surface, divide by 2 in warmer climates, by 4 in cooler climates

4. Discuss variables in N availability and percentage (above)

5. Discuss the application of the findings to the development of N budgets for farming systems. (See Unit 1.11, Reading and Interpreting Soil Test Reports for more on nutrient budgeting.)

Adapted from: *Managing Cover Crops Profitably, 2nd Edition*, published by the Sustainable Agriculture Network (see Resources section). Used by permission.

Hands-on Exercise: Seed Drill Calibration

step-by-step instructions for students

OVERVIEW

This exercise takes you through the steps needed to determine the amount of seed (pounds/acre) that your seed drill is discharging. Based on this information you can adjust your seeder to ensure that it is discharging at the recommended pounds per acre rate.

PROCEDURE

1. 3-point seed drill hooked to tractor
2. Row crop area cleared for cover crop planting (100' minimum plus room for turning)
3. Duct tape and cardboard (to make divider in drill hopper)
4. Cover crop seed
5. Flags to mark start and stop location of drill
6. High quality scale to measure seed weight

STEP-BY-STEP INSTRUCTIONS

1. With duct tape and a small piece of cardboard, tape a divider in the drill hopper to effectively “isolate” a single discharge opening at one end of the drill.
2. Disconnect the drop tube where it attaches to the disc opener and allow the tube to dispense seed into a small container or clear plastic bag taped to the tube.
3. Set two flags in the ground alongside a non-paved avenue at 100 feet apart.
4. Place a small amount of seed into the hopper over the drop that you have isolated with the cardboard “dam.”
5. Select the gear and RPM that you will be driving in the field—around 3 or 4 MPH.
6. Set the seed delivery opening based on seed rate charts supplied with the drill. If charts are not available you will have to simply estimate an opening width that is just slightly larger than the largest seed.
7. With the drill lined up at the first flag drive the tractor and drill 100 feet to the second flag along the avenue at the selected speed with the drill “engaged” to drop seed between flags. With a three-point drill this is easily accomplished by simply dropping the drill to allow the seed agitator drive wheel to make contact with the soil so that it can “drive” the agitator.
8. When you reach the 2nd flag remove the collected seeds and place them on a high quality scale to get an accurate weight.
9. Count the total number of drops on the drill and multiply the seed weight of the collected seed by the total number of drops. This will give you the total estimated drill output for the 100-foot pass.

10. Measure the width of the drill in feet and multiply the drill width by 100 to get the total square feet of the “trial area.”
11. Divide 43,560 (# square feet per acre) by the square footage of your “trial area” and this will give you the total number of “trial areas” within an acre.
12. Now multiply the estimated seed weight from all of the drops by the number of “trial areas” in an acre and this will give you a good estimate of drill output in lbs per acre based on your selected drill opening size.
You may need to repeat this procedure several times to find the appropriate seed drop opening size to match your desired output in pounds per acre (lbs/ac).

EXAMPLE OF CALCULATIONS

Your grain drill is 7 feet wide and has 13 drops. You select an opening size and run the drill 100 feet at the same gearing and rpm that you will be using in the field. You collect seed from the isolated drop and put it on the scale. It weighs 4 ounces (.25 lb).

1. Multiply .25 by 13 giving a total drill output of 3.25 lbs per 100 feet.
.25 lbs × 13 = 3.25 lbs
2. Now multiply the 7-foot drill width by 100 feet to giving you 700 square feet of “trial area.”
7 feet × 100 feet = 700 square feet
3. Now divide 43,560 (square feet per acre) by 700 to give the number of “trial areas” in an acre.
43,560 sq ft / 700 sq ft = 62 trial areas per acre
4. Now multiply the number of trial areas by 3.25 lbs to get total lbs of cover crop per acre.
62 trial areas × 3.25 = 201 lbs per acre

Assessment Questions

1) Define the following terms:

Cover crop

Green manure

Catch crop

2) In what ways do cover crops serve to improve or maintain the nutrient availability of agricultural soils?

3) In what ways do cover crops serve to improve or maintain the physical properties of agricultural soils?

4) In what ways do cover crops play a preventive pest management role in agricultural systems?

5) What are the factors to consider when selecting a cover crop for your farm or garden?

Assessment Questions Key

1) Define the following terms:

- *Cover crop* = Mainly used to prevent soil erosion by covering soil with living plants
- *Green manure* = Crop grown mainly to be turned under for soil improvement
- *Catch crop* = Used to “catch” nutrients left after harvest of a cash crop and prevent leaching

2) In what ways do cover crops serve to improve or maintain the nutrient availability of agricultural soils?

- *Legume cover crops* are able to “fix” atmospheric nitrogen (N_2) and convert it into a plant-useable form. Up to 200 lbs/acre of actual N can be fixed by certain species of cover crops. This can be a significant contribution to the N budget of a cash crop. Grains and cereal cover crops with extensive root systems that develop quickly after planting are also able to “scavenge” water-soluble nutrients left in the soil after the cash crop and prevent loss through leaching. Deep-rooted legume cover crops are also able to access normally unavailable nutrients (e.g., P) from lower soil horizons and bring them to the surface through the distribution of the nutrients through their tissues. Such nutrients are then made available to cash crops when cover crops are tilled into the soil.

3) In what ways do cover crops serve to improve or maintain the physical properties of agricultural soils?

- *Cover crops help prevent soil erosion.* When tilled in, cover crops cycle organic matter through agricultural soils. This cycling of organic matter provides energy (carbohydrates) and nutrients (N) that increase soil biological activity. Through the process of decomposition, soil organisms bind soil particles together forming stable (erosion-resistant) soil aggregates that improve and maintain desirable soil structure.

- *Cover crops improve drainage.* Some deep-rooted cover crop species can help to break through compacted layers in the soil and improve drainage.

4) In what ways do cover crops play a preventive pest management role in agricultural systems?

- *Provide habitat for beneficial insects and spiders:* Though not well studied in annual cropping systems, it is clear from research in orchards and vineyards that cover crops provide good habitat for beneficial insects especially when species with food sources such as extrafloral nectaries (e.g., vetch) or flowers are used
- *Certain cover crops suppress soil borne pests and diseases,* although some also may increase susceptibility of the cropping system to certain pests and diseases
- *Cover crops can suppress weeds:* Cover crops can reduce weed populations by outcompeting weeds by more vigorous growth and dense canopy cover or by releasing allelopathic compounds that inhibit weed seed germination, although they do need to be managed well to provide these functions and not increase weed pressure

5) What are the factors to consider when selecting a cover crop for your farm or garden?

- **Step 1:** Identify what you want the cover crop to do.
- **Step 2:** Identify where the cover crop can fit in your crop rotation and what the climatic and soil conditions are at that time.
- **Step 3:** Select cover crop species or mix to meet the goals and requirements from steps 1 and 2, considering the characteristics you don't want as well as those you are looking for. Consider the cost and availability of seed and the number and types of field operations required to manage the cover crop.

Resources

PRINT RESOURCES

Chaney, David, and Ann Mayse, eds. 1997. *Cover Crops: Resources for Education and Extension*. Davis, CA: UC Sustainable Agriculture Research and Education Program (UC SAREP), UC Division of Agriculture and Natural Resources.

A collection of materials that educators will find useful in conveying information about cover crops to farmers and ranchers. The packet includes a variety of materials that may be used in short courses, seminars, workshops, etc.

Includes web resources, print publications and articles, cover crop profiles, listings of video and slide sets, and a directory of expertise.

Order from the UC SAREP website:

www.sarep.ucdavis.edu.

Miller, P. R., W. L. Graves, et al. 1989. *Cover Crops for California Agriculture*. Leaflet 21471. Oakland, CA: University of California Division of Agriculture and Natural Resources.

A concise overview of the common cover crops used in California agriculture. Addresses annual and perennial cropping systems.

Smith, R., R. L. Bugg, and M. Gaskell. 2011. *Cover Cropping for Vegetable Production: A Grower's Handbook*. Publication #3517. Oakland, CA: University of California Division of Agriculture and Natural Resources.

Describes primary cover crop species, including grasses, legumes, mustards and other cool-season and warm-season options. Photos, seeding details, winter vigor descriptions, nitrogen fixation and scavenging, weed suppression and nematode resistance are included for each species. Addresses the effects of cover cropping on water management, pest management and farm economics.

For California growers, the handbook also discusses differences in cover crop use for the Central Valley, Desert and Coastal regions.

Sarrantonio, M. 1994. *Northeast Cover Crop Handbook*. Emmaus, PA: Rodale Institute.

Practical information on the selection and management of cover crop species for northeast agriculture.

Schahczenski, Jeff, and Holly Hill. 2009. *Agriculture, Climate Change and Carbon Sequestration*. ATTRA–National Sustainable Agriculture Information Service. IP 338. attra.ncat.org/publication.html

Provides an overview of the relationship between agriculture, climate change and carbon sequestration. Investigates possible options for farmers and ranchers to have a positive impact on the changing climate and presents opportunities for becoming involved in the emerging carbon market.

Sustainable Agriculture Network. 2007. *Managing Cover Crops Profitably, Third Edition*. Sustainable Agriculture Network. Beltsville, MD: National Agricultural Library.

Excellent information on the characteristics, costs, seeding rate, and management of different cover crop species. Contains a good introduction to the potential advantages and disadvantages of using cover crops, and how to manage them effectively to minimize unwanted effects. It also provides comprehensive information on the major species used in the U.S. Though geared primarily toward large-acreage cropping systems, the information is readily adapted for smaller-scale systems. Available for download and purchase at: www.sare.org/Learning-Center/Books/Managing-Cover-Crops-Profitably-3rd-Edition

USDA Natural Resources Conservation Services. 2011. *Carbon to Nitrogen Ratios in Cropping Systems*

Two-page handout from USDA describes importance of C:N ratio in feeding soil microorganisms, the effects on soil cover decomposition, and the effects on nutrient cycling. Includes a table of C:N ratios of various crop residues and other organic materials, and their comparative decomposition rates. Available at: www.nrcs.usda.gov/Internet/FSE_DOCUMENTS/stelprdb1166766.pdf http://C_N_ratios_cropping_systems.pdf

WEB-BASED RESOURCES

Brassicas and Mustards for Cover Cropping in Organic Farming

www.extension.org/pages/18643/brassicas-and-mustards-for-cover-cropping-in-organic-farming

Describes the potential benefits of using brassicas and mustards as cover crops. Thoroughly researched with an extensive references section, the article describes species selection, management techniques, and precautions.

Choosing and Using Cover Crops in the Home Garden and Orchard

casfs.ucsc.edu/about/publications/for_the_gardener.html

Orin Martin, manager of UC Santa Cruz's Alan Chadwick Garden, discusses the benefits, varietal selection, timing, planting, and incorporation of cover crops on a home garden and backyard orchard scale. 3 pages.

Cover Cropping Systems for Organically Farmed Vineyards

cemendocino.ucanr.edu/files/17082.pdf

Glenn McGourty, viticulture and plant science advisor for UCCE in Mendocino and Lake Counties, describes management of cover crops in organic viticulture systems. He includes a "top ten cover crop picks" for the region, including several plants not described in this chapter. A 2008 paper by McGourty and colleagues and published in California Agriculture describes self-reseeding annual legumes for untilled vineyards (<http://californiaagriculture.ucanr.org/landingpage.cfm?articleid=ca.v062n04p191&fulltext=yes>).

Cover Crops Topic Room, Sustainable Agriculture Research and Education (SARE)

www.sare.org/Learning-Center/Topic-Rooms/Cover-Crops

This informative website offers educational materials on a variety of topics, including cover crop selection and management, crop rotations, economics, and pest management. Especially useful are the short videos of growers describing their experiences with cover crops.

Diverse Cover Crop Mixes for Good Soil Health

www.nrcs.usda.gov/Internet/FSE_PLANTMATERIALS/publications/nypmssy11419.pdf

Paul Salon, a plant materials specialist with the USDA, discusses the pros and cons of using various mixes of cover crops species, particularly in relation to no-till systems in the Northeast.

Estimating Plant Available Nitrogen (PAN) Release from Cover Crops

ir.library.oregonstate.edu/xmlui/bitstream/handle/1957/34720/pnw636.pdf

This publication developed by Oregon State University researchers provides a step-by-step guide to estimating the N contribution of cover crops. It also includes a variety of informative case studies, including replacing organic fertilizer N with cover crops, and comparing the plant available nitrogen (PAN) of various cover crops used alone and in mixes.

Inoculation of Legumes for Maximum Nitrogen Fixation

extension.psu.edu/plants/crops/forages/successful-forage-establishment/inoculation-of-legumes-for-maximum-nitrogen-fixation

Penn State University publication describes techniques for inoculating legumes, factors affecting N fixation, checking roots for inoculation, and "emergency" inoculation techniques.

Mixtures and Cocktails: Soil Is Meant To Be Covered

www.ctic.org/media/pdf/Cover%20Crops/Mixtures%20and%20cocktails.pdf

Steve Groff of Cedar Meadow Farm describes his use of cover crops, including tillage radish, to build soil organic matter on the farm. Originally published in the Journal of Soil and Water Conservation.

Overview of Cover Crops and Green Manures

attra.ncat.org/attra-pub/summaries/summary.php?pub=288

Excellent resource from ATTRA covering the principal uses, benefits, limitations, and economics of cover crops. Includes extensive references and resources.

Perennial Cover Crops in Orchards and Vineyards.

www.yolorcd.org/documents/perennial_cover_crops.pdf

Agricultural Water Quality Best Management Practices handout outlines management and costs of cover crops in orchards and vineyards.

Plant Cover Crops

plantcovercrops.com/

Dave Robison, a cover crop and forage agronomist in the Midwest, keeps a blog about cover crops. While most posts are pertinent to his home region, some have excellent crossover for growers throughout the country.

Soil Quality for Environmental Health: Cover Crops

soilquality.org/practices/cover_crops.html

Developed by the Agricultural Research Service scientists, this introduction to cover crops addresses the question of why to use cover crops, the effects on soil health, and practical “how-to” information on selecting, planting, fertilizing, and terminating cover crops.

UC Sustainable Agriculture Research and Education Program (UC SAREP) Cover Crop Data Base

www.sarep.ucdavis.edu/database/covercrops

Contains a thorough cover crop database, with quantitative information on specific cover crops, and two slide shows covering the use of cover crops for annual and perennial farming systems. The database includes valuable cover crop information such as pounds of nitrogen fixed, seeding rates, suggested timing for seeding, etc. Focuses on California and other similar climatic situations. Includes photographs.

VIDEOS

Brennan, Eric. Agriculture Research in High Value Organic Systems.

www.youtube.com/user/EricBrennanOrganic

Eric Brennan, a USDA Cooperative Extension Specialist in Monterey County, California, has created a series of informative and entertaining videos on cover crops and the issue of organic versus conventional comparisons.

SUPPLEMENT 1

Cover Cropping and Other Agroecological Practices Benefit Farms in the Face of Climate Change

There is nearly universal scientific and cultural consensus that climate change is having a significant effect on our planet and on many climate-related activities, including agriculture. Agriculture is also a major source of greenhouse gas (GHG) emissions, accounting for 14% of GHG emissions worldwide.^{1,2} How farmers will satisfy the demand for food as the global population increases while mitigating agriculture's impact on climate change is the key question facing growers and policymakers around the world.

Currently, there is mounting evidence that suggests sustainable agriculture practices, exemplified by those used in agroecological systems, provide an opportunity to achieve the dual goals of feeding a growing population and shrinking agriculture's carbon footprint, in addition to the social benefits of increased food security and stronger rural economies. This is in contrast with industrial-scale conventional systems that rely on fossil fuel-based fertilizers, pesticides, and heavy tillage and look to genetic engineering to help plants cope with climate change, e.g. by developing drought-resistant crop varieties, which themselves require high inputs of fertilizers and pesticides to produce optimally. Agroecological systems, on the other hand, can mitigate climate change by reducing fossil fuel use, and employing farming techniques that reduce GHG emissions by sequestering carbon in the soil.

Of the range of practices in an agroecological system that address issues related to climate change, cover cropping is perhaps the most effective. As climate change continues to affect weather patterns and cause more frequent and severe weather events, protecting against soil erosion will become increasingly important. Cover crops provide an effective

mitigation strategy by protecting soil against water- or wind-driven erosion.

Cover cropping also provides other climate-related benefits, including: an on-farm source of fertility, less dependence on fossil fuels and their derived products, and adaptability and resilience. Most of all, while the specific species, timing, and primary purpose of a cover crop vary geographically, the principles behind their cultivation are universally applicable and their benefits universally available.

The use of a leguminous cover crop to fix nitrogen in the soil over the wet season for the next season's crop is widely recognized as an effective fertility management tool. According to an FAO report on agriculture in developing countries, using cover crops in a maize/pigeon pea rotation led to increased yields and required less labor for weeding than continuous maize cropping systems with conventional fertilizer use.³ Nitrogen-fixing cover crops also greatly reduce, and in some cases eliminate, reliance on off-farm sources of fertility, thus reducing the overall carbon footprint of the farm while maintaining high fertility levels in the soil. Note that even organic fertilizers have a high embedded energy cost as they are mostly derived

1 IPCC. 2007. Climate Change 2007: Mitigation. Contribution of Working Group III to the Fourth Assessment Report of the Intergovernmental Panel on Climate Change, Chapter 8-Agriculture. Cambridge, United Kingdom and New York, NY, USA Cambridge University Press.

2 Branca, Giacomo, Nancy McCarthy, Leslie Lipper, and Maria Christina Jolejole. 2011. Climate-Smart Agriculture: A Synthesis of Empirical Evidence of Food Security and Mitigation Benefits from Improved Cropland Management. Mitigation of Climate Change in Agriculture Series 3. Rome, Italy: Food and Agriculture Organization of the United Nations (FAO). www.fao.org/docrep/015/i2574e/i2574e00.pdf

3 Silici, Laura. 2014. Agroecology: What it is and what it has to offer. IIED Issue Paper. International Institute for Environment and Development, London. Available online at: pubs.iied.org/pdfs/14629IIED.pdf?

from manure from animals raised in confined feedlots, so the ability to grow one's fertility needs on farm is important across different agricultural systems.

Cover crops are not only a mitigation strategy for climate change, but also a cost-saving measure. Synthetic fertilizer costs have steadily increased over the last half-century, causing hardship for farmers in developing countries especially where fertilizer prices are already two to three times the world price. Organic farmers are less vulnerable to price shifts in fertilizer, but can equally benefit from the reduced need for compost as a result of cover cropping. By saving seeds from their cover crops, farmers can close the loop in their cover crop management, save on annually purchased seed, and develop strains well-adapted to local conditions. Fertility management systems based on cover crops insulate conventional farmers from increasingly frequent spikes in fertilizer prices and provide organic farmers with a cheap and renewable source of fertility.

Adaptation and resilience are also crucial to farmers' long-term success in the face of unpredictable and disruptive effects from a changing climate because so much of agriculture depends on constantly changing climatic conditions. Added to climate change are increasing input prices and a growing demand for food that put pressure on farmers to maintain high yields while paring down on costs. Cover crops can provide farmers with the flexibility they need by protecting topsoil from wind and

water erosion, storing a reliable supply of nutrients to the soil, and—if managed correctly—minimizing costly weeding requirements. For many resource-poor farmers who maintain livestock, cover crops provide a path to financial independence and food security as they can be grown both for soil fertility and livestock feed.

Cover crops as part of a climate mitigation strategy also make sense at every scale of agriculture. Large conventional farms require consistently high yields to stay profitable as they often operate on razor thin margins. To achieve this goal, these farms rely heavily on fossil fuel-based sources of energy and fertility. Whether used on conventional or organic farms, cover cropping not only reduces farm emissions, but also contributes to the biological health of the farm's aggressively cultivated soils.

Many organic farms at all scales already use cover crops as part of their fertility management program, contributing to the sustainability of the overall system. Subsistence and small-scale farmers in developing countries who do not already practice cover cropping can benefit greatly in production and climate-related sustainability from adopting locally relevant techniques. And finally, low-cost, locally available sources of fertility are vital to the viability and success of urban agriculture projects that rely on cost minimization and closed-loop systems since external resources are not as readily available or economical in cities.

SUPPLEMENT 2

Cover Crop Selection, Planting Tips, Tools, & Techniques for Small-Scale Organic Vegetable Farms on California's Central Coast

This supplement to the cover crop lecture addresses the various steps involved in using cover crops on small-scale organic vegetable farms on the Central Coast of California. Although the information is targeted to the Central Coast region, the techniques and approaches are applicable to many settings.

Soil Preparation

In many ways planting a cover crop is similar to planting a cash crop. Good soil preparation is critical: it provides good soil tilth and drainage and allows for accurate and uniform seed placement. The time and effort that go into soil preparation prior to cover crop planting are directly related to the quality and uniformity of the cover crop stand and its ability to outcompete weeds, establish a strong, deep root system, and produce optimal biomass.

Factors to consider when preparing ground for cover crop planting include:

- cropping and tillage history
- soil type
- time of year
- soil moisture content
- type and amount of residue to incorporate
- planting method (broadcast or drill)
- type and seed size of cover crop to be planted (i.e., cereal, legume, mustard)
- method of covering
- extent of soil compaction
- timing in relation to predicted rainfall events

Timing is often the single most important factor in determining the extent of ground preparation prior to cover crop planting. If there is adequate time between cash crop removal and cover crop planting this can be a good window to get in and level field ends. These “unleveled” field ends result from soil movement during discing, bed shaping and cultivation passes throughout the production season and can result in non-uniform drainage and puddling issues that will directly impact cover crop stand uniformity and weed growth.

Generally speaking the smaller the cover crop seed size the more care required to prepare a good seed bed with adequate soil particle size. This will

facilitate shallow planting depths, good water infiltration and uniform germination. Cereal cover crops generally require less intensive soil preparation, are less sensitive to depth of planting, outcompete weeds better and can handle compaction better than the mustards and legume mixes.

Soil preparation will depend in part on the preceding crop:

- Following low-residue crops with minimal compaction and low residual moisture (e.g., winter squash), preparation may only require flail mowing and a single pass with an offset disc and ring roller to adequately prepare the ground for either drilling or broadcasting cover crop seed (see discussion of both techniques, below).
- Following high-residue crops grown on beds (e.g., sweet corn), preparation may require flail mowing and numerous passes with an offset disc and ring roller to knock down the beds and sufficiently incorporate the residue prior to planting cover crop.
- Following overwintered, intensively managed crops (e.g., strawberries), preparation may require multiple passes with an offset disc and ring roller to knock down the beds followed by chiseling or ripping to break up deep furrow compaction created by harvest foot traffic and tractor tires.

Breaking up deep furrow compaction with chisels or rippers often brings large clods to the surface. It may take multiple passes with an offset disc and ring roller to break apart the clods and prepare the ground for cover crop planting. In severe cases, especially on soils that tend to compact easily, overhead irrigation may be needed before tilling to moisten the clods enough to facilitate their dispersal.

Many smaller farms rely on tractor-mounted rototillers to prepare ground for cover crop planting. When rototillers are used it is important to be mindful of issues related to aggregate dispersion and compaction. Rototillers are best used as a “single pass” implement when soils are not too wet and not too dry.

Cool Season Cover Crops: Selection and Timing

In areas of the Central Coast where winter rainfall typically exceeds 25 inches per year, and especially on sloped ground, cover cropping in annual vegetable cropping systems is highly advisable to protect non-cropped soil from both erosion and nutrient leaching.

Based on numerous studies, the optimum time for planting winter cover crops on the Central Coast is mid October. In our mild winter climate we can plant cover crops as late as January, however the best results in terms of weed suppression, stand uniformity, and biomass production are from cover crops planted in mid to late October or early November.

Depending on rainfall patterns it is often critical to get winter cover crops planted prior to the onset of heavy winter rainfall. Cover crop ground preparation and planting are best accomplished when soil is dry enough to work without the risk of compaction, which can result in poor drainage and clod formation. This is especially important on heavier soils.

Because timing is critical, growers need accurate long-range weather forecasts to help determine when to prepare ground and plant fall cover crops. Timing these operations is directly related to soil type and rainfall amounts, so each farm will have a different set of criteria on which to base ground preparation and planting schedules: the heavier the soil and the greater the rainfall, the tighter the window for fall planted cover crops. There is often a very tight window between cover crop planting and harvest of fall crops which, coupled with the potential for significant rain events, can add considerably to the excitement.

COOL SEASON COVER CROP MIXES

Selecting optimum cool season cover crop mixes is challenging since there are so many factors involved. The optimum mix provides early and uniform stand establishment, good weed competition, and minimal pest and disease pressure. It “catches” potentially leachable nutrients, does not lodge or

fall over in high wind and heavy rainfall events, does not set viable seed prior to incorporation, fixes nitrogen, does not get too carbonaceous prior to incorporation, and is relatively easy to incorporate and quick to break down once incorporated. The ideal mix also improves overall soil health and helps form stable soil aggregates by providing adequate amounts of carbon as a food source for the soil microbial communities.

There are many commercial mixes available that come close to meeting most of the above criteria. A good standard mix that has proven successful at the Center for Agroecology & Sustainable Food Systems (CASFS) Farm on the UC Santa Cruz campus over the past 20 years is a 50/50 mix of bell beans and lana vetch with no more than 7% (by weight) cayuse oats, planted at a rate of about 175 lbs per acre with a no-till drill.

Other considerations in fall cover crop mixes:

- Common or Purple vetch work well and are often less expensive than lana vetch, although lana vetch does seem to be the best vetch for our region in terms of hardiness and overall vigor.
- Peas make a nice component in a legume mix, but our experience at the UCSC farm is that they are more prone to root rot when compared to the vetches and bell beans, especially when soils are wet at time of germination.
- Cayuse oats are much slower to initiate flowering and are therefore much easier to incorporate in the spring compared to the cereal ryes—especially in higher rainfall areas on heavier soils. When the oats are planted at a percent (by weight) much greater than 7% they will often dominate the legumes. With an oat-dominated cover crop spring incorporation will be difficult and the time required for breakdown after incorporation will be much greater compared to the legume-dominated mixes.
- Cereal ryes are excellent weed suppressors, but start to initiate bloom much earlier than cayuse oats. Once flowering is initiated they have a high C:N ratio and can therefore be difficult to incorporate. If using rye, the advantage of AGS104 rye compared to Merced rye is that it has a much higher resistance to rust fungus.

When using specific legume species for the first time in a production system, it is advisable to inoculate the seed with the specific microbial inoculant for that species. When planting the seed through a drill or broadcast seeder it is best to order the seed “pre-

inoculated” rather than attempt to inoculate it yourself, since it is necessary to get the inoculant to “stick” to the seed using various methods that usually involve wetting the seed. Some growers simply shake the dry inoculant over the seed as it is being dumped in the seed hopper, but this may not provide the best results. Once established in a cover cropped field, the rhizobial bacteria will persist as long as the legume species specific to that bacteria are planted frequently.

Mustards also work well as a winter cover crop; they suppress weeds effectively and are easy to incorporate in the spring. Recent research also suggests that chemicals released from the mustards following incorporation can suppress some nematode species, they are less effective at controlling soilborne diseases. Because they are sensitive to less than optimal soil conditions such as poor drainage and compaction at the time of planting, mustards tend to be good indicators of soil conditions.

When drilled, mustards do well at a planting rate of about 20 to 30 lbs per acre. Because mustard seed is so small it can be challenging to set a drill to plant less than 30 lbs per acre unless the drill has a specially designed “small seed” delivery mechanism. For this reason it is common for growers to broadcast mustard seed and incorporate it with a very shallow harrow or ring roller.

Warm Season Cover Crops

There are many options available for mid- and late-summer cover crops in the Central Coast region. Water use and “land out of production” are the two biggest challenges with summer cover crops, but in a diverse system they can provide good weed suppression and nutrient cycling, and can significantly improve soil tilth and aggregation when planted in rotation with mixed vegetables.

The two most commonly used summer cover crops in our region are annual buckwheat and sudan grass. Buckwheat is the fastest-growing summer cover crop, and when planted at a high enough density and irrigated up, annual buckwheat will outgrow and “smother” most of the fast-growing summer annual weeds such as pigweed and lambsquarter.

Once incorporated, buckwheat residue breaks down easily, allowing for seedbed preparation soon

Nitrogen Contribution from Cover Crops

Nitrogen made available to plants through “fixation” of atmospheric nitrogen from legume cover crops is an important consideration when selecting winter cover crops. As a general rule legume residue, at time of incorporation, can produce about 3,000 pounds per acre residue on a “dry weight” basis. The nitrogen content in most legume cover crop residue, at time of incorporation (full bloom), is typically about 3%. Based on these numbers a typical legume cover crop would contribute about 90 pounds of nitrogen to the soil. About half of this nitrogen becomes plant available through microbial “mineralization” during the first year following incorporation. Based on these estimates a cropping system following the incorporation of a legume-dominated cover crop could receive 45 pounds of plant available nitrogen that could be utilized by a “cash crop” following the cover crop.

Legume cover crops typically have a higher level of N than is needed for the formation of soil organic matter and it is this excess N (estimated at 50%) that becomes plant available soon after incorporation. The remaining N goes into soil organic matter and is slowly released over time through microbial decomposition..

after incorporation. Growers always comment on the noticeable improvement in soil quality following buckwheat.

Note that buckwheat is not very drought tolerant and therefore must be sprinkler irrigated at least every 7 to 10 days on the Central Coast. If planting buckwheat with a drill, a good seeding rate is around 60 lbs per acre. If broadcasting, increase this amount to 80 lbs per acre.

Sudan grass is also a good summer cover crop and is relatively easy to grow. The advantages of Sudan are that it can be mowed and incorporated 40 days after planting when the plants are in full bloom (before the weeds have set hard seed) and it is a good weed competitor. Sudan grass grows best during very warm weather, so during cool foggy periods its growth may be less than optimal for good biomass production and weed suppression.

At the UCSC Farm we have had good luck intercropping vetch and sudan grass as a summer cover crop. The advantage of the intercrop is that if the weather is unseasonably warm during the initial growth stage the sudan will dominate and, conversely, if the weather is unseasonably cool the vetch will dominate. In either scenario the cover crop will provide good biomass and weed suppression. Typically, when intercropping two different species it is advisable to plant each at half the recommended

seeding rate. If planting a sudan grass/vetch mix with a drill, a good seeding rate is around 20 lbs per acre of each seed type. If broadcasting, increase this amount to 30 lbs of each per acre.

AGS104 rye or Merced rye will both germinate well and provide excellent weed suppression when grown as summer cover crops in our region, and can be mowed numerous times to keep biomass manageable and to knock off developing seed heads of escaped weeds. Cereals like rye and oats are typically drilled at around 80 lbs per acre and broadcast at between 100 and 120 lbs per acre. Residue breakdown and subsequent seedbed preparation will depend on the length of time the rye, sudan or vetch covers are allowed to grow prior to termination. Sudan grass can be drilled at 40 to 50 lbs per acre and broadcast at 60 lbs per acre. The higher the seeding rate the finer the stem will be and the easier the breakdown will be at time of incorporation.

Cover Crop Planting Methods

DRILLS

The best tool for planting cover crops is either a no-till or conventional grain drill. Depending on the scale of operation, either three point (7 to 8 feet wide) or wider pull-behind drills (10 feet or wider) can be used.

All grain drills have single or double disc seed-line openers, which facilitate planting into high residue situations often encountered when cover crops are planted following high residue cash crops such as corn or broccoli. Some drills, such as the no-till drills, have press wheels that run behind the disc openers, which help to re-establish capillarity to aid in bringing deeper soil moisture up to the seed; this feature greatly facilitates planting to moisture. The press wheels, which can be adjusted with spring tensioners, also facilitate accurately setting the planting depth, which is a critical factor as well when planting to moisture. Accurate seed depth is also easily set with a drill and information on how to set depth can be found in the operator's manual. Drills typically put down seed lines spaced from 6 to 7.5 inches apart, providing a close enough spacing for good early cover crop canopy closure, which will greatly reduce weed competition during the critical early cover crop establishment phase.

Drills typically have adjustable seed drop openers that allow for some level of accuracy in setting seeding rates. It is advisable to "calibrate" a drill to improve the accuracy of seeding, and thus avoid either over planting and running out of seed or under

planting and having seed left over (see Hands-On Exercise, Calibrating a Seed Drill).

Drills are fast and efficient at field planting cover crops once the proper seed delivery rate has been determined. The double disc openers seldom clog, but it is not uncommon for clogging to take place in the drop tubes especially when the drill is being used to plant large seeds at a high rate. The drill operator must continually monitor the output of the drops to ensure that no clogging is taking place. It is advisable to check drop output visually from the tractor seat at the end of each pass.

Another common problem is for the disc openers to pick up field trash (especially flags and berry bed mulch pins) that can jam the openers. The drill operator must also be cautious about not allowing the drill to move backwards while soil engaged, as this will often clog the openers with soil. A clogged drop is easily detected in the field since seed from the clogged tube will start to overflow at the top of the drop tube near the hopper, and a mindful operator will notice this overflow while running the drill. When using the drill after it has been parked for extended periods it is critical to blow out each of the drop tubes with compressed air or high-pressure water to clear out spider webs and other debris that can cause clogging.

When going into a field with the drill it often takes several feet of ground wheel operation for the seed to make its way through the delivery mechanism, down the drop tubes, and into the soil in the slot opened up by the disc opener. For this reason it is always advisable to make a final perpendicular pass along both edges of the field, filling in the areas that were potentially skipped as the drill entered and exited the field.

BROADCAST SEEDING

If a drill is not available the next best option is to broadcast the cover crop seed with a relatively inexpensive, three-point tractor mounted broadcaster. Small-scale growers planting out small areas (5 acres or less) can effectively broadcast cover crop seed using commonly available and inexpensive hand cranked broadcast seeders.

Seeding rates are challenging to set with broadcast seeders. Depending on the area to be broadcast it is often advisable to set the seed opening smaller than anticipated and make numerous passes over a field to improve overall uniformity of seed application. Note that it is important to measure out your field sizes and estimate the acreage prior to broadcasting so that you know exactly how much seed

needs to be broadcast on each block. Recommended seeding rates are typically increased by 30% when cover crops are broadcast and harrowed, compared to drilling, to compensate for the lack of seeding depth uniformity.

Once the seed is broadcast at the desired rate the grower must go back over the field with some type of secondary tillage implement to improve soil/seed contact to ensure adequate germination and minimize seed exposed on the surface. Secondary tillage implements commonly used to cover broadcast seed include spring tooth and spike tooth harrows and three point rototillers.

Implement choice will often depend on the amount of residue in the field, since spring tooth and spike tooth harrows tend to bring residue to the surface, which can negatively impact cover crop stand establishment. The drawback to rototillers is that they are best operated at much slower ground speeds than other types of harrows, so covering large areas can be time consuming.

Discs can also be used to cover broadcast cover crop seed, but setting the correct depth is critical to avoid placing the seed too deep and/or over mixing the soil. Tandem discs are better than offset discs for covering broadcast cover crop seed since they tend to move less soil and are less aggressive. If available, it is advantageous to pull either a ring roller or drag bar behind the disc or spring tooth harrow when covering cover crop seed to leave a uniform soil surface.

When broadcasting and harrowing cover crop seed, it is inevitable that some seed ends up getting buried too deep and some seed may be left on the surface where it is less likely to germinate due to either bird feeding pressure or inadequate moisture.

Other Planters

Tractor mounted, three-point, high-density planters commonly used for salad mix can also be used to seed cover crops and can provide an extremely high level of uniformity and accurate seed depth. These planters are best suited for planting on beds that are free of residue. And although cover crops are most commonly planted on flat ground when drilled or broadcast, planting on beds definitely has advantages, especially if the grower already has a high density planter capable of planting a single wide bed on a standard spacing of either 60 inches or 80 inches on center. The biggest challenge with this type of seeder is that they are not well suited to high residue situations.

Weed Management Strategies

Growers have several effective tools for dealing with weeds in cover crops. Perhaps the best tool is selecting the optimum seeding density and having the ability to plant uniformly, in terms of both density and seeding depth, in mid to late October for fall planted cover crops, when soil temperatures are conducive to quick cover crop germination; this allows the cover crop to effectively out compete weed seeds. Timing in relation to soil temperature is critical for success since cooler soil temperatures later in the fall will favor the success of winter weeds over the cover crops. Soil temperatures are not an issue with summer planted cover crops.

Other weed management tools include the use of cover crops known for their ability to outcompete weeds through allelopathy. Good examples of these include mustards and many of the cereals—most notably cereal rye—when planted as monocrops. Though effective at outcompeting weeds, growers must be mindful of the challenges of spring incorporation of cereal cover crops when planted as pure stands.

Although often difficult to achieve, one of the most effective winter cover crop planting strategies for good weed management is to drill cover crop seed into ground that has had a flush of weeds from either a light overhead irrigation or early rainfall event in the fall. Light tillage with a spring tooth cultivator or under-cutter bar at time of weed seed emergence will knock out the newly emerged weeds. If done correctly the cover crop seed (bell beans/vetch and oats) can then be planted into residual moisture and will germinate without additional rainfall or irrigation. This scenario will provide a strong and weed free legume/cereal mix cover crop stand. This technique is dependent on the use of a drill for planting (see above). Soil moisture is critical as well since too much moisture will have a potentially negative impact on soil compaction.

An effective way to deal with emerging weeds in a newly planted cover crop is to go over the field very quickly with either a rotary hoe or a tine weeder just as the cover crop (legume/cereal) is emerging. This technique is referred to as “blind” cultivation and can effectively clean up a weedy cover crop field. If the timing is right, the cultivation from the rotary hoe or tine weeder will not negatively impact (or only minimally impact) the emerging cover crop seed but will effectively disrupt, kill, and/or desiccate the newly emerged weed seeds that are much smaller and closer to the surface than the drilled

cover crop seed. This technique depends entirely on timing in terms of the stage of development of the cover crop and the stage of development of the weed seeds as well as soil moisture. Tine weeders work best when they can be run perpendicular to the drill lines—particularly on soils prone to crusting.

Incorporating the Cover Crop

On the Central Coast of California, incorporation of high residue cover crops can be extremely challenging. Because of our mild maritime-influenced winters and relatively high rainfall rates (typically 20 to 40 inches per year), a legume/cereal mix cover crop may produce 2 to 3 tons per acre of residue calculated as “dry weight.” The average weight per acre of a standing legume/cereal mix cover crop just prior to incorporation can be over 20 tons per acre (wet weight). At time of incorporation this residue typically has a very high moisture level and, depending on the level of maturity, can be carbonaceous and lignified. Because of these conditions it is advisable to flail mow the residue prior to incorporation to break up the stems into manageable sizes to facilitate incorporation into the soil.

Timing of incorporation is directly linked to soil moisture and the level of maturation of the cover crop. Every spring is different and cover crop incorporation timing often involves a lot of guessing about potential rainfall patterns and soil moisture and cover crop maturation dynamics. A standing cover crop can transpire a tremendous amount of water and soil moisture can vary at different depths, making incorporation decisions challenging.

The best method for determining incorporation timing is to walk the field with a shovel and dig numerous holes and “feel” soil moisture at various depths throughout the field. In medium- and heavy-textured soils you want to be able to form a ball of soil in your hand and then break it apart easily. For this exercise it is important to get soil from at

least 8 inches deep. If the soil “ribbons” easily when squeezed between your thumb and index finger it is probably still too wet to work (see Irrigation unit for more information on judging soil moisture by feel). Optimum soil moisture is critical for good incorporation and breakdown; in average rainfall years early April is commonly the best time for incorporation in the Central Coast region.

After flail mowing the residue needs to be mixed with the soil to enhance microbial breakdown and facilitate seedbed formation. The best tool for this is a mechanical spader.

Spaders are ideal for cover crop incorporation for many reasons. When operated in optimal soil moisture conditions spaders have minimal impact on soil aggregation and create almost no compaction compared to other primary tillage tools. Spaders are capable of uniformly mixing the cover crop residue into the tilled zone (roughly 12 inches with most spaders) while at the same time leaving the soil lofted and well aerated, allowing for ideal conditions for microbial breakdown of the residue.

Spaders also have two major drawbacks: they are expensive, and they require very slow gearing and high horse power (HP) to operate; 10 horse power per working foot of spader is the basic requirement depending on soil conditions and depth of operation. They run at a very slow ground speed, often in the range of 0.6 to 0.8 mph. Thus a 7-foot wide spader requires 70 HP and takes between 3 and 4 hours to spade an acre. Although time consuming, the results are impossible to replicate with any other tillage options now available.

If a mechanical spader is not available the next best and probably most commonly used tool for cover crop incorporation is a heavy offset wheel disc. Depending on the size and weight of the disc multiple passes are often required for adequate incorporation. Chiseling after the first several passes will facilitate the disc’s ability to turn soil and will also help break up compaction from the disc.

Appendix 1: Cover Crop Seeding Rate & Planting Depth Chart

COVER CROP	SEEDING RATE PER ACRE		SEED DEPTH
	DRILLED	BROADCAST	
Bell Beans	100 lbs	150 lbs	1"
Vetch	75 lbs	100 lbs	3/4"
Peas	100 lbs	150 lbs	3/4"
Cereal Grain	80 lbs	110 lbs	1"
Small Grass Seed	20 lbs	30 lbs	1/4"
Clover	20 lbs	30 lbs	1/4"
Mustard	20 lbs	30 lbs	1/4"
Sudan/Sorgham	40 lbs	50 lbs	1/2"
Buckwheat	75 lbs	100 lbs	1/2"

Note: These seeding rates and depths are approximate. The higher the seeding rate the higher the density and the better the weed control.

SEEDING RATE FOR LEGUME CEREAL MIX

Mix: 50% Bell Beans/50% Vetch + 7% Cayuse Oats (by weight)

Drilled rate: 150 to 175 lbs per acre

Broadcast rate: 200 to 250 lbs per acre

Appendix 2: Carbon to Nitrogen Ratios & Percent Nitrogen of Various Cover Crops

MATERIAL	C:N RATIO
Rye Straw	80:1
Oat Straw	70:1
Rye Cover Crop (mature)	40:1
Rye Cover Crop (vegetative)	30:1
Rye Cover Crop (immature)	15:1
Bell/Vetch Cover Crop	15:1
Crimson Clover	15:1
Compost	30:1
Corn Stalks	60:1
Sawdust	250:1

PERCENT NITROGEN

MATERIAL	C:N RATIO
Vetch	3.5
Rye (immature)	2.0
Rye (mature)	1.0
Bell/Vetch/Cereal Mix	2.5

Making and Using Compost

Introduction	297
Lecture 1: Making and Using Compost	299
Demonstration 1: Garden-Scale Compost Production	
Instructor's Demonstration	309
Students' Step-by-Step Instructions	312
Hands-On Exercise: Build and Monitor a Compost Pile	317
Demonstration 2: Field-Scale Compost Production	319
Assessment Questions and Key	321
Resources	325
Supplements:	
1. Making Quality Compost at a Garden Scale	327
2. Field-scale Compost Production: A Case Study	330
3. Built on Compost: The Good Food Revolution at Growing Power	333
Appendices	
1. Compost Time/Temperature Curve	335
2. Compost Food Web	336
3. C:N Ratio of Common Compost Materials	337
4. Calculating C:N Ratios for Compost—A Rough Guide	338
5. Compost Materials and Temperature Chart	339

Introduction: Making & Using Compost

UNIT OVERVIEW

High-quality compost is one of the essential organic matter inputs, along with green manures, used to manage soil health in organic farming and gardening systems. In this unit students will learn the fundamental concepts and practices used to produce quality compost with aerobic high-temperature composting techniques, with a focus on garden-scale practices.

The lecture introduces the biology of the composting process and the critical elements involved in successful compost production. Demonstrations provide instructions on the materials, suggested content, and activities for teaching students the basic skills and knowledge needed to produce high-quality compost on both field and garden scales. Using step-by-step instructions and a suggested hands-on exercise, students will build and track the progress of a garden-scale compost pile. Field-scale considerations are briefly reviewed and a case study included, along with an example of a successful urban composting program that also addresses healthy food access.

MODES OF INSTRUCTION

- > LECTURE (1 LECTURE, 1.5 HOURS)
The lecture reviews the benefits of composting and the biology of the composting process, emphasizing the key factors required for quality compost production and its use at the garden and farm scale.
- > DEMONSTRATION 1: GARDEN-SCALE COMPOST PRODUCTION (1–1.5 HOURS)
The garden-scale compost demonstration details how to construct, troubleshoot, and assess aerobic hot compost piles, including a step-by-step outline for students to follow.
- > HANDS-ON EXERCISE FOR STUDENTS (3 HOURS INITIALLY; MONITORING OVER 6 MONTHS)
This exercise takes students through the process of building and monitoring a garden-scale compost pile over several months.
- > DEMONSTRATION 2: FIELD-SCALE COMPOST PRODUCTION (1 HOUR)
The demonstration outline details how field-scale compost windrows are made and monitored.
- > ASSESSMENT QUESTIONS (1–2 HOURS)
Assessment questions reinforce key unit concepts and skills.

LEARNING OBJECTIVES

CONCEPTS

- The benefits of aerobic hot composting and the benefits of compost in soil
- The different stages of the biological composting process and the key composting organisms responsible at different stages
- The key factors for aerobic hot composting including carbon-to-nitrogen ratio, moisture, aeration, and volume

SKILLS

- How to assess compost materials
- How to build a compost pile
- How to troubleshoot, turn, and track a compost pile
- How to assess finished compost for various uses

Lecture 1: Making & Using Compost

Pre-Assessment Questions

1. What is compost?
2. What are some examples of composting systems and how do they differ?
3. Why is aerobic high-temperature composting favored for agricultural /horticultural purposes?

A. Compost and Types of Composting Defined

1. Composting defined
 - a) Composting is a biological, chemical, and physical, highly aerobic process that transforms large, bulky, coarse materials (mostly plants and animal manures) to a homogenous, stable end product that is: uniform, brown/black in color, crumbly in texture (slightly greasy), sweet smelling, and particulate. Finished compost is a source of nutrients for plant growth and a feedstock for soil organisms.
 - b) The process is biological as it is achieved by organisms. The actual decomposition is chemical via acids and enzymes. The physical aspect involves macroorganisms (mostly arthropods) and their chewing, shredding, and mixing actions. See Supplement 1, Making Quality Compost at a Garden Scale.
 - c) Compost can be used in two ways: As a soil builder/conditioner that improves the physical properties of a soil (especially structure and bulk density), and as a fertilizer, with both immediate and long-term effects
2. Examples of composting systems
 - a) Indore windrow method: The classic high-temperature aerobic composting method featuring animal manures and green waste, popularized by Sir Albert Howard. Growers and commercial producers use this method and its variations (e.g., the Luebke method)
 - b) UC Rapid Composting: Features frequent turning of the pile (daily or every other day) to rapidly produce compost (see Resources)
 - c) The UCSC Farm & Garden method: A variation of the Indore method; hand-built scale, high-heat aerobic piles for garden use
 - d) Sheet composting: Spreading and burying organic material (leaves, greens, etc.) over a garden bed or landscape, then digging it in to decompose. Additional nitrogen is sometimes applied.
 - e) Vermicomposting: Also known as worm composting, vermicomposting systems rely on earthworms (often “red wigglers”, *Eisenia fetida*) to digest and decompose organic material, resulting in nutrient-rich “castings” used as a fertilizer and soil conditioner
 - f) In-vessel composting: Features a closed system such as a building or large metal containers in which temperature and airflow can be controlled. Often used to compost municipal wastes.

B. Benefits of Aerobic Hot Composting

1. Advantages of aerobic hot composting process
 - a) Stabilizes volatile nitrogen. Composted organic matter contains nitrogen in a more stable form (nitrate) that is more usable by plants.
 - b) Kills most pathogens, e.g., *E. coli* and Salmonella, and weed seeds (if piles are above 131°F for 15 days)
 - c) Introduces a wider population of microbes than found in the raw ingredients
 - d) Reduces volume of wastes (by approximately 50%)

- e) Allows for use of raw materials that shouldn't be put directly in soil (e.g., sawdust, raw manure)
 - f) Degrades many contaminants since most pesticides are petroleum- (carbon)-based and thus digestible.
 - g) Recycles organic matter on farm and reduces off-farm inputs (nutrient cycling)
 - h) Improves bulk density, a measurement of a weight of a volume of soil including both the solids and the pore space. In general, a lower bulk density number means better soil conditions. Bulk density increases with compaction; soils with a high bulk density can restrict root growth.
2. Benefits of compost in the soil
- a) Improves soil structure and soil aggregate stability, resulting in better drainage, aeration, air/gas exchange, erosion resistance, tilth (workability), and the soil's ability to recover from compaction. Microbes in compost secrete glue-like compounds that help bind soil particles together.
 - i. Microbes, particularly bacteria, have a thick, mucilaginous capsule surrounding them that helps attach them to soil particles, and in turn to encourage individual soil particles to bind together into aggregates
 - ii. Soil microbes live within and between the micropores in soil aggregates, thus binding them into more stable aggregates. Bacteria do this by sticky exudates, fungi by the binding action of their hyphae.
 - iii. Soil microbes as well as plant roots exude sugar-like polysaccharides (non-sweet sugars) and other compounds that bind individual soil particles together
 - iv. The thread-like hyphae of fungi secrete a gooey protein called glomalin that also aids in aggregation
 - v. As organic residues decompose, gels and other viscous microbial byproducts are secreted into the soil and encourage a crumb or granular type of aggregation
 - b) Increases moisture retention
 - c) Provides a slow-release source of nutrients and increases availability of minerals. Increases Cation Exchange Capacity (CEC) and percent base saturation, thus increasing availability of Ca, Mg, and K. Also, humic and fulvic acids in finished compost help dissolve minerals in the soil, making phosphorus, calcium, magnesium, potassium, and other nutrients available to plants. See Unit 1.11, Reading and Interpreting Soil Test Reports, and Unit 2.2, Soil Chemistry and Fertility, for more information on CEC.
 - d) Increases the population and diversity of microbes in soil that continually make nutrients available to plants. Provides food for microbes.
 - e) Helps buffer soil pH by neutralizing both acid and alkaline soils and bringing the pH levels to the optimum range for nutrient availability to plants. Compost pH is optimally 6.0–7.0.
 - f) Compost organisms promote disease suppression by various tactics (competitive interactions):
 - i. Predation: E.g., fungi predate on detrimental nematodes)
 - ii. Competition: Outcompete pathogens for niches and resources
 - iii. Suppression: Produce acids and antibiotics that suppress or kill pathogenic organisms
 - g) Plays key role in soil fertility management in organic systems
3. Potential disadvantages of composting (see also L. Field Scale Compost Considerations, below)
- a) Cost and time: Many farmers and gardeners don't make their own compost because of equipment needs, materials costs, and labor expenses

- b) Space needed for composting can take up available production land
- c) Odor or other impacts on neighbors can create challenges in urban/suburban areas
- d) Rules governing compost production methods must be strictly followed if operating a certified organic farm (see National Organic Program, www.ams.usda.gov/nop for composting regulations)

C. Biology of the Composting Process

1. Compost ecosystem overview
 - a) What makes composting happen? A wide range of decomposers are naturally present in most soils and on organic matter. Microbial decomposers can account for 60%–80% of total soil metabolism. See the discussion and depiction of “Process and Participants” in Supplement 1 and Appendix 1, Compost Time/Temperature Curve.
 - b) Decomposer organisms play different roles in a complex compost food web (see Appendix 2, Compost Food Web). Microscopic organisms such as bacteria, fungi, actinomycetes, and yeasts are mostly primary consumers of compost materials. Macroscopic organisms such as mold mites, nematodes, springtails, centipedes, beetles, and earthworms feed on the primary and secondary consumers.
2. Key compost organisms
 - a) Bacteria are primarily responsible for the first stages of decomposition in the composting process
 - i. Feed on succulent plant materials such as simple sugars, plant saps, proteins and some starches. As their populations can double hourly, the initial rate of decomposition is rapid.
 - ii. Use primarily enzymes, manufactured from the N-rich material in the pile, to decompose the organic matter.
 - b) Fungi
 - i. Also decompose simple sugars, plant saps, proteins, and starches, but their primary role is to decompose the most resistant carbonaceous compounds in the pile, such as chitin, lignin, and cellulose
 - ii. Improve soil structure by physically binding soil particles into aggregates
 - iii. Suppress disease
 - c) Actinomycetes
 - i. Filamentous bacteria, some of which grow as segmented hyphae (strands) that resemble fungi. Actinomycetes give compost its earthy smell.
 - ii. Produce long, grayish, thready or cobweb-like growths that are most commonly seen toward the end of the composting process
 - iii. Can decompose complex carbon, including lignin, chitin and cellulose. Enzymes enable them to break down woody stems, bark, and newspapers.
 - iv. Responsible for some disease suppression (produce enzymatic compounds and antibiotics)
 - d) Macroorganisms: Earthworm and other later compost pile immigrants (see discussion of Process and Participants in Supplement 1)
 - i. Though not always present in finished compost, macroorganisms feed on the pile’s earlier inhabitants
 - ii. Examples: Nematodes, mold mites, springtails, wolf spiders, centipedes, sow bugs, earthworms, ground beetles (for more information, see Unit 2.3, Soil Biology and Ecology)

3. Compost temperature curve and bacteria (see Appendix 1)
 - a) 50°–113°F: Mesophilic (mid-temperature loving) bacteria and other organisms populate the pile in the first 24–48 hours, multiplying quickly and causing temperatures to rise with increased metabolism. As internal pile temperatures rise above 113°F, mesophilic organisms start dying out and thermophilic bacteria populations rise.
 - b) 113°–150°F: Thermophilic (heat-loving) bacteria, which are present as dormant spores at lower temperatures, multiply quickly in the heating compost pile. Temperatures can be sustained at 130°–150°F for two weeks or more. Turning the pile can help sustain high temperatures by reducing density of material and reintroducing oxygen for aerobic bacteria.
 - c) 150°F and above: May be too hot for thermophilic organisms to survive and biological activity may slow as a result. Temperatures optimally should remain at 150°F or below.
 - d) 120°F and below: After the first month, a compost pile will cool to the point where mesophilic organisms will populate the pile. Mesophilic bacteria repopulate, but fungi, actinomycetes, yeasts, and molds dominate this stage of composting.

D. Overview of Key Environmental Conditions for Aerobic, Hot Composting

Successful composting requires creating the right environmental conditions for decomposers to function optimally. Key conditions include:

- Carbon-to-nitrogen (C:N) ratio of materials
- Moisture
- Aeration
- Surface area of compost materials
- Volume of compost pile
- Turning and troubleshooting

E. Compost Materials: Key Considerations

1. Carbon-to-nitrogen (C:N) ratio (see Appendix 3, C:N Ratio of Common Compost Materials)
 - a) The carbon-to-nitrogen ratio refers to the proportion of carbon to nitrogen by weight in any organic matter. Different types of organic matter have different carbon-to-nitrogen or C:N ratios. For example, wood, which is very high in carbon, has a C:N ratio of 500:1 while grass clippings have a C:N ratio of 17:1.
 - b) C:N ratio of a material can change due to many factors: Plant growth, storage, how fertilized, what an animal was fed. Numbers on a chart are approximations.
 - c) The optimum C:N ratio for biological activity is between 25:1 and 30:1. Compost piles should ideally start with an overall C:N ratio in this range. The C:N ratio of finished compost will be 14:1 to 17:1. Much of the carbon in the pile is released as CO₂ as decomposers metabolize organic matter.
2. Nitrogenous materials
 - a) Compost materials with low C:N ratios are often called nitrogenous, sometimes “greens”
 - b) There is a range of nitrogenous materials as demonstrated on the C:N ratio charts (see Appendix 3)
 - c) C:N ratio of a material can change: As a growing plant ages it develops more carbon (e.g., young green grass growing into tall brownish-green stalks)
 - d) Storage/treatment: Use greens when fresh. If necessary, make a concentric pile of greens; tarp to preserve N and use as soon as possible.
3. Carbon materials
 - a) Compost materials with high C:N ratio are called carbonaceous, sometimes “browns”

- b) Carbon materials can be more or less complex as shown on C:N chart (e.g., wood chips can have C:N ratio of 400:1, straw 70:1, brown leaves 40:1; see Appendix 3)
 - c) High carbon materials can be stored easily to use later (e.g., store brown leaves or straw stubble from fall to mix with the abundance of greens in the spring)
 - d) Carbon materials can be bulkier and thus can provide aeration in a pile
 - e) High carbon materials often are dry and can be difficult to properly moisten (can be spread out and soaked or left out in rain)
4. Animal manures
- a) Manures are considered nitrogenous, but can have a wide range of C:N ratios depending on type of animal manure, feed source, bedding material, and age. See Appendix 4, Calculating C:N Ratios for Compost—A Rough Guide, for examples.
 - i. Poultry manure (approximately 6–12:1 C:N ratio) is high in nitrogen as well as phosphorus
 - ii. Horse manure (approximately 20:1 C:N ratio) mixed with bedding material (straw or woodchips). Bedding absorbs urine well, and half the N is in urine, half in manure. Manure can vary widely in its overall C:N ratio due to type and quantity of bedding material (e.g., is the “horse manure” pile mostly dry wood shavings? Think high carbon). Although not particularly high in nutrients (other than K), it is a great “tool” for building soil structure, whereas chicken manure is a more effective fertilizer.
 - c) In general, manures are more biologically active than plant residues due to having passed through an animal’s digestive system
 - d) Raw manures can carry weed seeds, pathogens, pesticide residues, and antibiotics, so should be composted properly. If applied directly to the soil, National Organic Program regulations dictate raw (uncomposted) animal manures must be incorporated a minimum of 120 days prior to the harvest of crops “whose edible portion has direct contact with the soil surface or soil particles, (e.g., leafy greens) or 90 days prior to the harvest of crops with no direct soil surface or soil particle contact.”
5. Balancing the carbon and nitrogen in a pile (see Appendix 4)
- a) Consider approximate C:N ratio of each ingredient as a reference in deciding on quantity. Larger compost operations may test the C:N ratio of each ingredient and come up with formulas for quantities.
 - b) For smaller, hand-built piles, layering is a good way to estimate proportions and “homogenize” the pile. Thin layers are recommended to put the diversity of ingredients in closer proximity. The aim here is to meet all necessary criteria (C:N ratio, water content, oxygen content, particle size) uniformly throughout the pile. Examples of proportions, by volume (see also Supplement 1):
 - 3 inches of fresh horse manure/bedding
 - 3 inches of loose succulent greens
 - 1/2 inch of loose oat straw (pre-wetted)
 Another option is a plant-based recipe:
 - 2 wheelbarrows of straw or deciduous leaves such as sycamore, oak
 - 1 wheelbarrow of loose succulent greens or packing shed scraps (carrot tops, beet tops, overgrown zucchini, etc.)
 - 1.5 five-gallon buckets of fresh, crumbly soil (from a recently turned bed)
 - c) For large-scale composting, materials are often laid out along a windrow to gauge proportions and then turned with a mechanized compost turner. See discussion of large-scale compost production, below, and Supplement 2, Field-Scale Compost Production—A Case Study.

- d) Trial and error: Make observations and keep records about what works, what doesn't (see Appendix 5, Compost Materials and Temperature Chart). Note that the quality of feedstocks directly influences the composting process, and thus the quality of the end product.
6. Other components some advocate adding to compost
- a) Clay soil: Those who use the Luebke method of compost think it's beneficial to use 10% clay soil in the pile because it reduces N losses, makes end-product more stable. Clay acts as a "colloidal trap," retaining nitrogen where microbes can convert it from a gaseous form into a useable form. Thin, repetitive layers of clay soil work best.
 - b) Rock phosphate can increase usable phosphorus by making P more available to crops and help reduce volatilization of NH_3 . By layering rock phosphate next to animal manures in a compost pile, the result is an increase in *Pseudomonas* spp. bacteria as well as nitrifying bacteria. These organisms immobilize both P and N in their bodies; when they die and decompose, those nutrients are liberated in a form available for plants to use.
 - c) Inoculants (purchased biological "activators"): May be useful for dealing with some problems, e.g., high oil content plant residues, but considered unnecessary by most because compost organisms are present in manures, soils, and on plant materials. Some use aged compost as an inoculant if the composting area is new or on concrete.
 - d) Wood ash: Using small amounts of wood ash in compost eliminates possible negative effects of high pH of ash when added directly to soil and adds potassium
 - e) Rock minerals (to help speed their availability through chemical breakdown)
7. What not to compost
- a) Though often discouraged, composting manure of humans or other carnivorous or omnivorous animals (dogs, cats, pigs) is possible, but you must be very careful about pathogens (see EPA and World Health Organization guidelines, and www.jenkinspublishing.com/humanure.html). Food safety and organic certification regulations may prohibit the use of these materials in compost; check current guidelines.
 - b) Perennial weeds that are resistant to decay such as Bermuda grass, oxalis, mint, bindweed
 - c) Some diseased plants, e.g., fire blight on pear/apple wood, *Phytophthora infestans* (late blight) on potatoes and tomatoes
 - d) Meat and dairy (if worried about attracting pests). Small amounts okay in center of pile.
 - e) Large quantities of fats and oils: Compost organisms can't readily break these down
 - f) Leaves of eucalyptus, walnut, and other trees with tannins or known allelochemicals; conifers (acidic, slow to break down). Small amounts of these materials are okay.
8. Particle size of materials
- a) Shredding or chopping materials, especially large, woody stalks, will speed the composting
 - b) The greater the surface area to volume ratio, the faster the rate of potential decomposition. Decomposers work on surfaces, so the more surface exposed, the more decomposers can work.
 - c) Compaction can occur if particle size is too small, and material is wet and nitrogenous (e.g., all lawn clippings), leading to loss of aeration and anaerobic conditions
 - d) Layering sequence and thickness can be adjusted to avoid compaction and maintain aeration; alternate large with small particle sizes
 - e) Waxy coated leaves decay very slowly because of coated surface

- f) Municipal compost tub grinders reduce materials to 1 inch or less. A sharp spade or machete can be used to chop materials by hand.

F. Moisture

1. Moisture needs of decomposers
 - a) All decomposers involved in composting need water
 - b) Aerobic microbes, similar to marine mammals, need water around them all the time, but also need oxygen to survive. They live and move around on a film of water.
2. Moisture content in compost pile should be 50%–60% (moist as a wrung-out sponge)
 - a) First consider the moisture of the materials to be composted
 - b) Add water as pile is built, watering dry layers especially. More water should be put on layers in top half of pile, as much will trickle down (apply approximately two-thirds in top half, one-third in bottom half).
 - c) Excess moisture will cause compaction, loss of air (you shouldn't be able to squeeze water out of compost)
 - d) Insufficient moisture will cause a pile to decompose slowly
 - e) If you're going to turn a pile frequently, you can add more water as you turn
 - f) Turn pile, troubleshoot—add water if too dry, aerate and add dry material if too wet
 - g) Seasonal moisture considerations: Tarp piles in winter to keep rain off; use compost covers, tarps or straw cap to conserve moisture in summer

G. Aeration

1. Aerobic bacteria, which make hot composting happen, require oxygen and respire carbon dioxide (CO₂)
2. Anaerobic bacteria populate portions of the pile where the oxygen content is low. They create methane gas and sulfur compounds (the rotten eggs smell) and can be harmful to soil life (commercial compost made in anaerobic digesters are often finished aerobically in windrows).
3. Oxygen is often the limiting factor when compost temperature goes down after first weeks
4. CO₂ can be monitored with special equipment—at 10–12% CO₂, need to turn the pile if possible
5. Turning the pile reintroduces oxygen, stimulating new growth of aerobic bacteria and further breaking down material, making it easier for microbes to decompose them. You can also break up anaerobic pockets within the pile as you turn it.

H. Volume and Temperature

1. Minimum pile size recommended is 5 feet x 5 feet x 5 feet to achieve the benefits of the hot composting process (although any almost any size can work, smaller piles will not heat up and will take longer to decompose)
2. At this volume the pile is self-insulating and can reach 130–150°F for 10 days to 3 weeks
3. 131°–145°F = optimal temperature range. Turn if reaches 150°F.
4. Maximum height and width should be 6 feet so as not to limit aeration or increase compaction of pile; air does not move more than 3–4 feet into a static pile
5. Compost fabric, straw cap, or soil cap can help retain some heat

I. Maturation and Turning

1. Most windrow piles take about 6 months minimum (spring into fall) to mature if not turned; longer in winter depending on climate. Note that National Organic Program (NOP) standards requires that windrows be turned five times, and remain at a temperature between 131°–170°F for 15 days, for use on certified organic farms. Be sure to check current regulations, as changes to these standards may occur.
2. Advantages of turning include:
 - a) Speeds composting process by aerating the pile
 - b) Achieves more thorough composting by moving outer materials to pile center
 - c) Allows for troubleshooting and adjustments to pile (great learning opportunity)
 - d) Additional mixing of ingredients
 - e) Physical (mechanical) breakdown of particle size of materials
3. Disadvantages of turning include:
 - a) Time, energy, expense
 - b) Loss of nitrogen as pile is turned
 - c) Additional space needed unless turning out and back
4. Turn at least once (more speeds process but is labor intensive by hand)
 - a) If you turn compost only once, ideally do so at 3 weeks or when temperature curve has clearly started back down. After turning at this stage, temperature curve will go up again. At this point oxygen is the limiting factor—turning reintroduces oxygen for aerobic organisms to continue using as they digest the still relatively fresh materials.
 - b) If you turn the pile twice, ideally turn at about 3 weeks and 6 weeks, again referring to heat curve for information

J. Assessing Compost Maturity and Stability

1. Parent material should be largely indistinguishable, texture should be crumbly
2. Temperature has cooled down to ambient temperature
3. Signs of macro life (e.g., redworms, sowbugs, springtails), though may not be present in large-scale operations
4. Dark brown to blackish-brown color
5. Earthy smell (no ammonia or anaerobic odor)
6. Feels “greasy” or slick when squeezed between fingers
7. Maturity vs. stability: A set of 7 quantitative indicators are used to define the maturity and stability of compost –
 - pH: 6.5 to 8.0
 - Sulfides: zero to only trace
 - Ammonia = <0.05 ppm
 - Ammonium: 0.2 to 3.0 ppm
 - Nitrites: <1.0 ppm
 - Nitrates: <300 ppm
 - CO₂: <1%

Quantitative indicators adapted from “Quality Guidelines for Compost Chart,” compiled by Jon Nilsson (East Coast Compost) and Atrusa Compost Consulting criteria (George Leidig, Blue Bell, PA)

K. Applying Compost

1. Timing
 - a) Spring, prior to planting
 - b) Mid season, as “side dress”: Placed around established plantings and worked into the top 1–4 inches of soil
 - c) Fall, with a planting of cover crops
2. Application rates
 - a) Application rates vary with intensiveness of cropping system and use of cover crops
 - b) Field scale: ~4–10 tons/acre on an annual basis
 - c) Garden scale: ~ 0.5–2 lbs/square foot (this = 10–20 tons/acre annually). 1–2 lbs/square foot for soil development, 0.5–1 lb/square foot for maintenance.
3. Placement
 - a) Field-scale: Incorporate into top 8–12 inches of soil
 - i. Side dress: In the root zone of the crop
 - b) Garden-scale
 - i. Initial stages of soil development: Incorporate into top 12–24 inches of soil (see Unit 1.2, Garden and Field Tillage and Cultivation, Appendix 3, French Intensive/Double Digging Sequence)
 - ii. Soil fertility maintenance: Incorporate into top 4–8 inches via side forking

L. Field-Scale Compost Production (see also Supplement 2, Field-Scale Compost Production—A Case Study)

Many growers buy commercially produced compost, and some make large volumes of compost on site using a windrow system and compost turner or front-end loader

1. Advantages of making compost on site
 - a) Quality control: Can monitor and maintain control, ensure quality end product
 - b) Effective use of culls, other on-farm waste materials that would otherwise have to be disposed of
 - c) Compost available when needed; commercial supplies not always available
 - d) Potential cost savings in making compost on site vs. buying from commercial source
 - e) Key part of soil health and fertility program; high quality compost helps ensure healthy soil
2. Challenges of making compost on site
 - a) Up-front costs for equipment—compost turner, appropriate tractor/bucket loader, and irrigation infrastructure, etc.—can be high
 - b) “Learning curve” involved: May take several years of fine tuning system to ensure reliable results
 - c) Requires reliable sources of quality feedstocks, e.g., green waste, manure. Materials and delivery costs can be high.
 - d) Requires labor inputs
 - e) Requires dedicated space for delivery of feedstock and windrowing
 - f) Requires water source
 - g) Must comply with local and state ordinances re: leachates, odors, other considerations
 - h) Certified organic operations must meet federal National Organic Program regulations; weather conditions (e.g., extended rainy periods), labor and time constraints can make requirements for 5 pile turnings in a 15-day period challenging

3. Recommendations if “buying in” compost from commercial producers
 - a) Monitor quality; ask for records of inputs and nutrient analysis
 - b) Visit the composting operation to inspect materials, practices used
 - c) If certified organic, make sure product is approved by the Organic Materials Review Institute (OMRI, www.omri.org)
 - d) Ensure adequate space available for deliveries

Demonstration 1: Garden-Scale Compost Production

for the instructor

OVERVIEW

Key to the process of building quality compost is the ability to assess the materials that will make up the pile. Before starting the pile-building demonstration, spend time discussing the materials you've gathered for the pile's construction. Providing a range of compost materials for discussion will enhance students' understanding of and skills in assessing carbon-to-nitrogen ratios, moisture content, and other variables of compostable materials. Variety also brings a wider range of nutrients and different feedstock for different types of microorganisms.

Useful comparisons for discussion include:

- green young weeds/grass clippings vs. older carbonaceous plants (same plant, different life stage)
- fresh manure vs. aged manure (horse, cow, chicken, other examples if possible)
- horse manure with straw bedding vs. horse manure with wood chips or shavings
- food scraps vs. crop residues

Spend time assessing various materials at the beginning of the demonstration and then review each as they are layered on the pile. Let students know that there is no one recipe for compost; each pile will differ based on the materials available, time of year, and the composter's own experience.

PREPARATION AND MATERIALS

1. At the compost site mark a 5 feet x 5 feet to 6 feet x 6 feet or longer area as the desired base of the pile.
2. Gather compost materials such as straw, greens (cover crops, crop residues, weeds), fresh horse manure, food scraps, chicken manure, brown leaves, older dried-out weeds or crop residues, etc. Make sure to have materials in sufficient quantities to complete at least a 5' x 5' x 5' pile. Keep each material in its own distinct pile (for comparison).
3. Gather tools, materials, and handouts: hose with sprayer, wheelbarrows, manure forks, spades, compost thermometer, compost materials and temperature record sheet (see Appendix 5, Compost Materials and Temperature Chart) and assignment sheet (see Hands-On Exercise).
4. Assess existing compost piles for examples of various stages of decomposition, piles built with different techniques or materials, and piles that may be too wet, too dry, etc. As an option, bring in some different compost samples. Include good examples of finished compost. Plan which to visit at end of demonstration.

PREPARATION TIME

1–2 hours

DEMONSTRATION TIME

1–1.5 hours

A. Plan the Pile with Students

1. Compost materials assessment

Ask students to assess each compost material in terms of:

- a) Carbon-to-nitrogen ratio
- b) Moisture content
- c) Particle size
- d) Aeration

2. Pile location, size, shape

Discuss considerations for:

- a) Location
- b) Size
- c) Shape of pile

3. Considerations for layering

Plan how the pile will be built by discussing:

- a) Thickness of layers (as per material)
- b) Order of layers
- c) Amount of water to add to which layers (with more added in top layers than bottom)

B. Demonstrate Pile Building

1. Demonstrate proper tool techniques for safety and efficiency

- a) Discuss which tools are used and why
- b) Demonstrate proper use of each tool

2. Pile base

- a) Mark area for base size and discuss size parameters
- b) Demonstrate and discuss loosening soil within area
- c) Make first layer with manure or greens

3. Demonstrate layering (ask for 2–3 students to help)

Map out layering sequence and for each layer:

- a) Review considerations for each material to make appropriate thickness
- b) Show how to judge layer thickness, uniformity
- c) Demonstrate how to “cinch” or “scratch” each layer slightly into layer below. This can be done with long handled forks or pulling forks. The objective is to slightly mix together (homogenize) the layers differing in C:N ratio.
- d) Show how to keep pile square (mind corners and edges)
- e) Demonstrate how to add water as needed

4. Review layers and sequencing as pile progresses

- a) Ask students to build a several-layer sequence and explain their process
- b) Are there new considerations as pile progresses or as materials available change?
- c) Assess pile shape and size

5. Demonstrate finishing a pile

- a) 5 feet high = maximum
- b) Finish with a carbon layer (e.g., straw cap) or soil as a sealant to prevent volatilizing of N in top layer
- c) Show use of tarp or compost cloth
- d) Show how to label pile with date, materials used, other information

C. Monitoring the Composting Process

1. Why monitor and why keep records
2. Demonstrate/discuss compost thermometer (and other monitoring devices if available)
3. Demonstrate how to use materials and temperature record sheet (Appendix 5, Compost Materials and Temperature Chart); show examples of record sheets from past, including timing of turning/aeration with temperature dip

D. Demonstrate Turning a Pile

1. Review the pros and cons of turning
2. Review when to turn, how often to turn
3. How to turn—outside materials to inside
4. Troubleshooting as you turn

E. Assess Existing Piles or Compost Samples

1. Examine piles at different stages of decomposition looking for:
 - a) Heat, temperature curve examples (record book)
 - b) Odor, color, texture
 - c) Moisture
 - d) Recognizable parent materials
 - e) Different materials or techniques used
 - f) Show examples in continuum from coarse to finished
 - g) Examples of good, finished compost
2. Look for examples of problems to have students troubleshoot

F. Give students their compost-building and monitoring assignment (see Step-by-Step Instructions and Hands-On Exercise)

Demonstration 1: Garden-Scale Compost Production

step-by-step instructions for students

INTRODUCTION

Use this set of instructions as a reference as you build and monitor compost piles

A. Planning the Pile

1. Compost materials assessment

Assess each of the gathered compost materials in terms of:

 - a) Carbon-to-nitrogen ratio
 - i. Is the material high in carbon? High in nitrogen? Or nearer to the ideal composting range of 25:1 to 30:1 carbon-to-nitrogen (C:N) ratio?
 - ii. How might age and storage have affected its C:N ratio?
 - iii. If manure, how would the quantity and type of bedding affect its C:N ratio?
 - b) Moisture content
 - i. How much moisture is coming in with material? (e.g., lawn clippings can be 70% moisture)
 - ii. How much water should be added given time of year, ambient temperatures, rainfall?
 - iii. Aiming for 50%–60% moisture content—“moist as a wrung-out sponge”
 - c) Particle size
 - i. How will the particle size of the material affect the pile’s compost process?
 - ii. Should something be chopped up? How?
 - d) Aeration
 - i. How will this material affect the overall aeration of the pile?
 - ii. If it might tend to compact, what can be done to lessen this effect?
2. Plan pile location, size, shape
 - a) Location considerations
 - i. Proximity to use area, water source, materials source
 - ii. Ease of construction and access around pile
 - iii. Shaded area best to reduce drying in summer
 - iv. Compost piles located beneath trees may lose nutrients to tree roots
 - b) Size considerations
 - i. Width and height—5 to 6 feet (for aeration and for easier access as building)
 - ii. Length: 5 feet (minimum) to any length
 - iii. Assess quantity and quality of usable material. How long a pile can you plan to make?
 - c) Shape of pile
 - i. Aim for vertical sides to maximize volume of pile
 - ii. To retain moisture through summer, build pile with a flat top and a thick “cap” of straw

- iii. Piles built to overwinter should have a more rounded top to shed rain (with straw cap)
3. Considerations for layering
 - a) Thickness of layers (as per materials)

Use thin layers for materials at either extreme of the C:N ratio range. Examples:

 - i. Approximately 1- to 3-inch layers for things that are high C (straw)
 - ii. Approximately 1- to 3-inch layers for things that are high N (fresh horse manure)
 - iii. Approximately 4- to 6-inch layers for mid-range C:N materials (mixed weeds/ crop residues)
 - iv. Use thin layers if particle size and/or moisture content make compaction likely
 - b) Order of layers
 - i. Some say you can speed decomposition by putting the manure layer (with its high population of microorganisms) on top of the green layer (with the most readily available food source in the form of plant saps)
 - ii. Mixing or scratching layers slightly together helps homogenize pile, avoid compaction
 - c) Amount of water to add (to which layers; top vs. bottom)
 - i. Consider the material of each layer—moisture, particle size
 - ii. Water each layer that needs additional moisture
 - iii. Add more water to layers in top half of pile (some will trickle down to lower layers)

B. Building the Pile

1. Review proper tool techniques for safety and efficiency
2. Establish the pile base
 - a) Mark off area for base size (5 feet x 5 feet or longer)
 - b) Loosen soil in area with a spading fork to enhance aeration and migration of organisms
 - c) Make first layer with manure or greens (enhance migration of soil organisms to higher N food source)
 - d) Pile will be most compacted and thus least aerated at bottom. Bulky materials in base can aid in aeration but may make pile harder to turn.
3. Building layers

As each layer is made:

 - a) Review key considerations for each material to make appropriate thickness (relative C:N, particle size, moisture, aeration)
 - b) Make layer uniformly thick
 - c) Scratch (mix) each layer slightly into the next using spading fork or manure fork
 - d) Keep pile square by pulling/adding material to corners and edges and tamping walls with fork
 - e) Use hose sprayer to add water to layers that need it, paying attention to the corners and edges. Some materials (straw, dry manure) should be scratched with forks as watered to allow more even distribution of water.
4. Review key considerations as pile progresses
 - a) Build a several-layer sequence and review key considerations as you go
 - b) Assess new considerations as the pile progresses or as materials change (e.g., the weed pile first had fresh green weeds on the top, but now it's just older, brownish weeds)
 - c) Assess the pile shape and size as you progress

5. Finishing a pile
 - a) 5 feet high = maximum for access/ease of building and for aeration
 - b) Finish with a carbon layer (if pile is not to be finished that day, end with carbon)
 - c) Use a tarp or compost cloth as protection from rain and from drying. Compost cloth “breathes”; tarps can limit aeration so some just use for rain.
 - d) Label pile with date, materials used, other information

C. Monitoring and Recording the Composting Process

1. Monitor temperature with compost thermometer
 - a) Take temperature daily for first month and after turning; then weekly
 - b) Temperature should be taken at several points in the pile and averaged
 - c) Thermometer should be inserted 18 inches to 2 feet into pile
 - d) Hold thermometer by probe while inserting and removing
2. Record temperature and observations on record-keeping sheet (see Appendix 5)
 - a) Track pile through decomposition process, creating heat curve graph as you go
 - b) Use heat curve graph to assess pile performance, indicate when to turn

D. Turning a Pile

1. Review the pros and cons of turning
2. Turn at least once (more often speeds process but is labor intensive by hand)
 - a) If only turning once, ideally do so at 3 weeks or when temperature curve has clearly started back down. At this point oxygen is the limiting factor—turning reintroduces oxygen for aerobic organisms to continue using as they digest the still relatively fresh materials.
 - b) If turning twice, ideally turn at about 3 weeks and 6 weeks, again referring to heat curve for information (e.g., dip in temperature)
3. Turn outside materials to inside and inside to outside
 - a) Pull outside materials off pile (outer foot of material will be drier, less decomposed). Set aside.
 - b) Water outer layer of materials
 - c) Spread a base layer of inner materials in space next to original pile
 - d) Mix outer materials into center of new pile as you rebuild with inner materials (don’t try to recreate original layers)
4. Troubleshoot any problems as you turn the pile
 - a) Break up dry pockets or compacted clumps
 - b) Water if too dry
 - c) Leave overly-wet materials spread out to dry.
 - d) Add nitrogenous materials if pile has not heated up and moisture is fine
 - e) Low heat piles will still compost with time if you can’t “fix” problem(s)
 - f) “Failed” piles can be used as material for a new pile

E. Assessing Piles and Documenting Observations

1. Examine piles at different stages of decomposition for:
 - a) Heat, temperature curve
 - b) Odor
 - c) Moisture
 - d) Recognizable parent materials
 - e) Different materials or techniques used
 - f) Examples of good, finished compost
2. Look for trouble signs
 - a) Too wet (can squeeze water out)
 - b) Too dry (usually doesn't heat up properly, may have dry pockets)
 - c) Anaerobic conditions (smells like sulfur, usually wet and compacted)
 - d) Didn't heat up (could be lack of moisture, improper C:N ratio)
3. Make written recommendations for achieving desired rate of decomposition and implement them
 - a) Heat, temperature curve examples (record book)
 - b) Odor, color, texture
 - c) Moisture
 - d) Recognizable parent materials
 - e) Different materials or techniques used
 - f) Show examples in continuum from coarse to finished
 - g) Examples of good, finished compost

Hands-on Exercise: Build & Monitor a Compost Pile

step-by-step instructions for students

SUMMARY

In groups of 2 to 3, you will build a group compost pile, and monitor its progress over the next 6 months. The step-by-step outline (pages 1-313–1-316) can serve as a guideline as you build the pile and later as you turn it. Use the Compost Materials and Temperature Chart (Appendix 5) to list materials and the sequence of layers, and to record temperatures, observations, and other data.

GROUP RESPONSIBILITIES INCLUDE:

- Assessing the available compost materials
- Planning compost layering
- Building the pile
- Keeping records on the pile (see record sheet in appendices) including labeling (name of pile, ingredients, date); record observations; daily temperature readings for first month; weekly temperature readings for subsequent months
- Turning the pile at least once (at 3 weeks or so)
- Troubleshooting any problems
- Answering the questions below after 1–2 months

QUESTIONS ABOUT YOUR PILE

1. How hot did your pile get and how long did it sustain this heat?
2. How does the heat curve on your pile compare to others you have seen? What assumptions can you make based on this heat curve?
3. When you turned your pile, what was your assessment of it? What if any troubleshooting did you need to do?
4. When you dig into your pile now, what recognizable materials remain? How does the pile smell, feel, look?
5. What other observations have you made about your pile?

Demonstration 2: Field-Scale Compost Production

for the instructor

OVERVIEW

This demonstration introduces the considerations, techniques, and mechanical equipment used in on-farm production of compost for use on a multi-acre scale. Students will first review the characteristics of compost feedstock, the importance of adequate moisture during the composting process, and be provided with examples of the temperature changes occurring in previously built compost piles. The instructor should also discuss optimal and necessary temperature ranges for organic certification, materials and techniques used to maintain optimal conditions for aerobic decomposition, and the various indicators used to determine compost maturity. In the second part of the demonstration, the instructor presents the specific techniques and equipment used in combining materials, monitoring and turning large compost piles, and factors to consider in applying finished compost. This exercise requires access to a commercial composting operation or farm that makes its own compost. See also Supplement 2, Field-Scale Compost Production—A Case Study.

PREPARATION AND MATERIALS

1. At the compost site mark a 5 feet x 5 feet to 6 feet x 6 feet area for preparation and materials.

Ideally, materials for this demonstration would include mature compost, immature compost, an active compost pile, sample feedstock, and compost turning and application equipment, as well as temperature, turning, and feedstock records from recent compost piles. A laboratory nutrient analysis of compost should also be available.

DEMONSTRATION RESOURCES

- California's CalRecycle program, www.calrecycle.ca.gov/organics. Website offers extensive information on compost use in agriculture, including case studies of compost use and scientific research on compost's effects, as well as a list of compost and mulch suppliers.
- Magdoff, Fred, and Harold van Es. 2009. Chapter 13: Making and Using Composts in *Building Soils for Better Crops: Sustainable Soil Management, 3rd Edition*. Sustainable Ag Network Series Handbook #10. Produced by the Sustainable Agriculture Research and Education Program (SARE) and the US Department of Agriculture. Available free online: www.sare.org/Learning-Center/Books/Building-Soils-for-Better-Crops-3rd-Edition
- *Field Guide to On-Farm Composting*. 1999. Available from Natural Resource, Agriculture, and Engineering Service (NRAES) Cooperative Extension, 152 Riley-Robb Hall, Ithaca, New York 14853-5701, www.nraes.org.
- Rynk, Robert (editor). 1992. *On-Farm Composting Handbook*. NRAES 54. Ithaca, NY: Northeast Regional Agricultural Engineering Services

PREPARATION TIME

1 hour

DEMONSTRATION TIME

1 hour

DEMONSTRATION OUTLINE

A. Field-Scale Compost Making

1. Review compost-making process
 - a) Examine feedstocks
 - b) Discuss C:N ratios of various feedstocks
 - c) Discuss importance of supplying adequate moisture during the composting process
2. Review temperature curves from past piles
3. Discuss National Organic Program definition of compost and requirements for compost production and use
4. Discuss importance of monitoring CO₂ levels as a guide for turning
5. Discuss optimum and required temperatures
6. Examine breathable tarp used for covering pile
7. Review and discuss nutrient profile of laboratory analysis of finished compost
8. Discuss indicators of compost quality and maturity (see J on page I-304 of the Lecture)

B. Equipment and Techniques for Windrowing, Turning, and Field Application of Compost

1. Explain and demonstrate how feedstock is layered for initial mixing
2. Explain and demonstrate how water is applied as necessary during the mixing process
3. Explain and demonstrate how feedstock is run through spreader to form windrow
4. Explain and demonstrate how compost pile is turned
5. Demonstrate and discuss techniques used in field application of compost
6. Discuss application rates of compost

7) What factors can influence the C:N ratio of a material?

8) What may happen if too much water is added to a compost pile? What may happen if the materials are too dry?

9) Why is aeration important in a compost pile?

10) What are some advantages and disadvantages to turning a compost pile? When and how often should compost piles be turned? (Please explain.)

11) Describe five qualitative indicators of compost maturity. What are some quantitative ways of assessing compost maturity and stability?

12) Imagine that you have an unlimited amount of each of the following materials for composting: Straw, chicken manure, horse manure, food scraps, greenish-brownish crop residues and weeds, and sawdust. How would you make a pile using these materials? Draw a diagram of the pile you would create. Discuss your layering, including thickness of each layer, order, water added or not. Add a short description of your suggested management plan (turning, monitoring).

Assessment Questions Key

1) List four benefits of aerobic, high temperature composting.

- *Stabilizes volatile nitrogen. Composted organic matter contains nitrogen in a more stable form that is more usable by plants.*
- *Kills most pathogens and weed seeds (if piles are above 131°F for 15 days)*
- *Introduces a wider population of microbes than found in the raw ingredients*
- *Reduces volume of wastes (by approximately 50%)*
- *Allows for use of raw materials that shouldn't be put directly in soil (e.g., sawdust, raw manure)*
- *Degrades contaminants since most pesticides are petroleum- (carbon-) based and thus digestible. Organic matter also has a high capacity to bind heavy metals.*
- *Guarantees that most of the end product will be humus and slowly-decomposing material that will become humus in the soil*
- *Recycles organic matter on the farm and reduces off-farm inputs*

2) List four improvements to soil quality that would result from regular incorporation of compost into the soil.

- *Improves soil structure and soil aggregate stability resulting in better drainage, aeration/gas exchange, erosion resistance, workability (tilth). Microbes secrete glue-like compounds that help bind soil particles together.*
- *Increases moisture retention (100 lbs. of humus can hold 195 lbs. of water)*
- *Slow release of nutrients and increased availability of others. Cation Exchange Capacity (CEC) is increased thus increasing availability of Ca, Mg, and K. (Also humic acids help dissolve minerals in the soil, making more minerals available to plants.)*
- *Increases the population and diversity of microbes in soil that continually make nutrients available to plants. Provides food for microbes.*
- *Helps buffer soil pH (compost pH is optimally 6.5–8)*

- *Promotes disease suppression (different microbes suppress Fusarium, Pythium, Phytophthora, Rhizoctonia)*
- *Plays key role in soil fertility management in organic systems. Along with soil organic matter and cover crops, compost is a major source of plant available N, P, and K.*

3) Name the key decomposer organisms and describe their role at the various composting stages/temperatures.

- *Bacteria: Aerobic bacteria are the primary decomposers in the first stages of decomposition, feeding first on the most readily-available food sources like plant sugars. Their role is to do most of the primary consumption of simple carbon compounds, resulting in the liberation of heat and the warming of the compost pile and creating the environmental conditions for the subsequent colonization of microorganisms (below).*
- *Fungi: Fungi decompose complex carbon compounds like chitin and cellulose*
- *Actinomycetes: Actinomycetes decompose complex carbon, like chitin and cellulose*
- *Macroorganisms: Earthworms and other later immigrants such as nematodes, mold mites, springtails, wolf spiders, centipedes, sow bugs, earthworms, ground beetles continue to break down organic matter after the pile has cooled*

4) What temperature range is considered best for composting and why? What is too hot?

- *Between 131°–150°F for a minimum of 15–21 days. This should kill potential pathogenic organisms and weed seeds and prevent the volatilization of nitrogen containing compounds (e.g., ammonia) at higher temperatures.*
- *Maximum temperatures of the compost pile should not exceed 150°F*

5) List the key conditions necessary for aerobic, high temperature composting.

- *Proper carbon to nitrogen ratio of materials: 25:1–40:1*
- *Moisture: 50%–60% by weight or “moist as a wrung-out sponge”*
- *Aeration: Periodic re-aeration through turning*
- *Surface area of compost materials: Small particle size will result in more rapid decomposition*
- *Volume of compost pile: A minimum of 5x 5x 5 is recommended*
- *Turning and troubleshooting: Compost piles should be turned when temperatures exceed 150°F and when the temperature of the pile has begun to decline. National organic standards require 5 turnings within a 15-day period with a sustained temperature of 131°–170°F.*

6) Why consider the Carbon-to-Nitrogen ratio of the various compost materials? What is considered the ideal C:N range for composting and why?

- *C:N ratio affects the rate of decomposition. A low C:N ratio (below 25:1) may result in too rapid decomposition and the loss of nitrogen in the form of ammonia. A C:N ratio that is too high may result in a too long a decomposition process and a low quality end product.*
- *Ideal C:N ratio range is 25:1–40:1*

7) What factors can influence the C:N ratio of a material?

- *C:N ratio of a material can change due to many factors: plant growth, storage, how fertilized, and what an animal was fed*

8) What may happen when a pile is too wet or too dry?

- *If a compost pile is too wet it may not heat up, turn anaerobic, forming compounds that may be offensive smelling and detrimental to plant growth if not aerated prior to application*

- *If a compost pile is too dry it may not heat up or not sustain heat long enough to degrade the organic materials into a finished and useable product. Will often require reassembling the materials and moistening.*

9) Why is aeration important in a pile?

- *To assure adequate amounts of oxygen for aerobic decomposition*

10) What are some advantages and disadvantages to turning a compost pile? When and how often should piles be turned? (Please explain)

- *Compost piles should be turned when temperatures exceed 150°F or when the temperature of the pile has peaked, plateaued, and begun to decline. National organic standards require 5 turnings within a 15-day period with a sustained temperature of 131°–170°F. The greater the number of turnings, the faster the material will break down.*

11) Describe five qualitative indicators of compost maturity.

- *“Parent material” should be largely indistinguishable*
- *Texture should be crumbly*
- *Very small particle size*
- *Temperature has cooled down to ambient temperature*
- *Signs of macro life (e.g., redworms, sowbugs, springtails)*
- *Dark brown to blackish-brown in color*
- *Earthy smell (no ammonium or anaerobic odor)*
- *Feels “greasy” or slick when squeezed between fingers*

What are some quantitative ways of assessing compost maturity and stability?

- *Compost maturity and stability may also be determined through measurements of carbon dioxide and ammonium levels. This is commonly done in large-scale and commercial composting operations.*

Resources

PRINT RESOURCES

BOOKS

Brady, Nyle C. and Ray R. Weil. 2008. *The Nature and Properties of Soil, 14th Edition*. Upper Saddle River, NJ: Prentice Hall.

Comprehensive (965 pages) textbook on soils—great for those who want to “go deeper” into the origins, classifications, and workings of soil.

Cantisano, Amigo. 2012. *Know Your Soil: A Handbook for Understanding and Utilizing a Soil Analysis for Organic Growing, 3rd edition*. N. San Juan, CA: Organic Ag Advisors.

This 27-page booklet includes information on making and applying compost, and tips on what to look for when purchasing commercially made compost.

Dougherty, Mark (ed.). 1999. *Field Guide to On-Farm Composting*. NRAES-114. Natural Resource, Agriculture, and Engineering. Ithaca, NY: Cornell University Cooperative Extension.

A handy reference guide that helps on-farm composters find practical information about composting quickly and easily. Includes sections on equipment, compost recipes, site considerations, environmental control, and compost use.

Gershuny, Grace. 2011. *Compost, Vermicompost, and Compost Tea: Feeding the Soil on the Organic Farm*. White River Junction, VT: Chelsea Green Publishing Co.

Covers the principles and biology of composting, including methods, materials, and costs. Includes information on compost tea and vermicomposting, along with a section on legal issues related to composting and the National Organic Program. Appendices include recipe calculator, potting mix recipes that use compost, and sample compost production budget sheets.

Gershuny, Grace. 1993. *Start with the Soil*. Emmaus, PA: Rodale Press.

Includes an introduction to the tools and techniques of home- and garden-scale composting.

Howard, Sir Albert. 1943. *An Agricultural Testament*, Oxford, UK: Oxford University Press, archived from the original on 2 July 2010, pdf per Special Rodale Press Edition, 1976.

Jeavons, John. 2012. *How To Grow More Vegetables, Fruits, Nuts, Berries, Grains, and Other Crops Than You Ever Thought Possible on Less Land Than You Can Imagine, 8th Edition*. Berkeley, CA: Ten Speed Press.

Includes a section on the tools and techniques of home- and garden-scale composting.

Magdoff, Fred, and Harold van Es. 2009. *Building Soils for Better Crops: Sustainable Soil Management, 3rd Edition*. Sustainable Ag Network Series Handbook #10. Sustainable Agriculture Research and Education Program (SARE) and the US Department of Agriculture. www.sare.org/Learning-Center/Books/Building-Soils-for-Better-Crops-3rd-Edition

This 294-page book covers all aspects of building healthy soil, including a section on making and using compost.

Martin, Deborah, and Grace Gershuny, eds. 1992. *The Rodale Book of Composting: Easy Methods for Every Gardener*. Emmaus, PA: Rodale Press.

A comprehensive introduction to home- and garden-scale composting, including a chapter on large-scale composting.

Smillie, Joe, and Grace Gershuny. 1999. *The Soul of Soil: A Soil-Building Guide for Master Gardeners and Farmers, 4th Edition*. White River Junction, VT: Chelsea Green Publishing.

Contains a brief section on farm-scale composting.

Stell, Elizabeth P. 1998. *Secrets to Great Soil*. North Adams, MA: Storey Publications.

Contains an introduction to the tools and techniques of home- and garden-scale composting.

Van Horn, Mark. 1995. *Compost Production and Utilization: A Growers Guide*. Publication 21514. Oakland, CA: University of California Division of Agriculture and Natural Resources.

Includes sample calculations for achieving optimal C:N ratios, suggestions on compost management, nutrient profiles, and nutrient release patterns of composts.

PERIODICALS

BioCycle. The JG Press, Inc. www.biocycle.net
Offers business-oriented information on composting, anaerobic digestion, and biofuels processing.

WEB-BASED RESOURCES

Biocycle Magazine
www.biocycle.net/magazine/
BioCycle magazine online.

CalRecycle (California)
www.calrecycles.ca.gov/organics/
Includes extensive information on compost use in agriculture, including case studies, commercial compost sources, and state regulations.

California Integrated Waste Management Board
www.ciwmb.ca.gov
Provides health and safety information for composting.

Cornell University: Cornell Composting
compost.css.cornell.edu/index.html
Provides access to a variety of composting educational materials and programs developed at Cornell University.

EPM, Inc.
www.wormwigwam.com
Procedures for composting using earthworms, and a worm-composting system offered for sale.

Klickit County, Washington Solid Waste
www.klickitatcounty.org/solidwaste/fileshtml/organics/compostCalcAbout.htm
Resources for calculating the C:N ratio of compost piles.

National Organic Program

www.ams.usda.gov/nop

Provides regulations and standards for meeting composting requirements for organic certification. See Title 7, Agriculture; Part 205-National Organic Program; Subpart C-Organic Production and Handling Requirements, for rules relating to compost production.

Washington State University: Center for Sustaining Agriculture and Natural Resources

csanr.wsu.edu/compost/

WSU's compost research and education program provides useful information on large- and small-scale composting, use of composts, and regulations.

University of California Vegetable Research and Information Center

vric.ucdavis.edu/pdf/compost_rapidcompost.pdf

Information from University of California plant pathology professor Robert Raabe on a technique to rapidly produce compost, featuring frequent pile turning. 2 pages.

Worm Digest

www.wormdigest.org

Information, networking, and resources on all aspects of vermicomposting.

VIDEOS

The Compost Video Series. University of California Cooperative Extension Master Gardeners of Orange County, California. Available at uccemg.com/Soils-Fertilizers-Compost/Composting-Video-Series-386/

Nine short videos address a variety of home composting topics, including how to start, turn, and troubleshoot a compost pile.

Do the Rot Thing: The Simple Art of Home Composting. 1998. Alameda, CA: Alameda County Waste Management Authority and Recycling Board (22 minutes). Available on YouTube (search by title).

Covers the basics of home-scale composting.

SUPPLEMENT 1

Making Quality Compost on a Garden Scale

Compost, the process and the product, is an example of harnessing biology to assist in promoting healthy soil that in turn grows quality crops. Composting is about the decomposition and transformation of heterogeneous organic wastes (anything that was once alive) into a homogeneous, stable end product—organic matter/humus, that is, compost. Quality compost is a uniform product black in color, crumbly in texture, sweet smelling, slightly greasy to the touch, and a powerful reservoir of plant nutrients that are released slowly over time via further biological activity.

Benefits

Among the attributes of compost are –

- Immobilizes nutrients in the bodies of microorganisms. This keeps nutrients, especially nitrogen, from leaching out of the pile. When the finished compost is applied to the soil, nutrients are released slowly and in forms available to plants.
- Increases soil organic matter and cation exchange capacity.
- Provides a feedstock of nutrients as well as the “habitat” for beneficial soil microbes.
- Kills (some, not all) plant pathogens and weed seeds during the composting process.
- Inoculates the soil with beneficial microbes (bacteria, fungi, actinomycetes, etc.).
- Improves soil structure by promoting soil aggregation (binding soil particles together), which in turns promotes aeration, moisture retention, permeability, and consistency, thus improving the “workability” of a soil.
- Usually panacea-like in solving whatever problem your soil has.

Process and Participants

In constructing a compost pile you are setting the stage for the biological, chemical, and physical decomposition of bulky organic wastes and recycling of nutrients, taking the large, the rigid, the dry (think corn stalks), as well as the particulate, the wet and the slimy (think matted grass clippings or soggy kitchen scraps) and then transforming them.

This is a highly aerobic process, as oxygen fuels the metabolism of the microbes principal in the decomposition process. In fact, you could refer to a compost pile as a “microbial layer cake.” The

decomposition is carried out by succeeding waves (populations) of micro- and macro-organisms. You play the role of facilitating this process. In a sense, composting is a form of animal husbandry or “microbe farming.”

As with any successful husbandry effort, habitat, diet, and water are the key building blocks of a successful compost pile. A compost pile is simply “pasture” for microbes. Via its ingredients, the pile provides a feedstock for the initial microbial populations and eventually the “finishers” or “shredders and chewers,” macro-organisms such as earthworms, mites, sow bugs, centipedes, millipedes, etc. Microbial populations tend to be ubiquitous, thus there is no need for inoculants, as small populations exist on much of the substrate used in composting.

The composting process has three distinct phases:

- 1: Mesophilic (50°–113°F) – Moderate temperatures, usually lasting under a week**
- 2: Thermophilic* (113°–150°F) – High temperatures, usually lasting 3–4 weeks**
- 3: Curing – Ambient temperatures, lasting >3 months**

**small piles, made incrementally, will not get very hot*

During the first phase, waves of bacteria and fungi multiply rapidly and feed on the succulent plants in the pile. When the pile is properly constructed, the first 24–48 hours feature an explosive, literally exponential growth of these organisms (bacteria can double their populations every 20–60 minutes). Often, there is no recognizable plant material in the pile after even a few days thanks to the chemical decomposition taking place. Remember, bacteria and fungi do not have mouthparts, and thus do not chew; rather, they secrete enzymes and acids that break down plant materials, and absorb the sugars and simple proteins for nutrition.

The next phase of decomposition features thermophilic, or heat-loving, organisms—still some bacteria, but increasingly, fungi. Fungi decompose (again, chemically) more complex carbon compounds such as chitin, cellulose, and lignin.

As the pile cools and begins its curing process, a third microbial population comes to the fore—a type of actinobacteria often referred to as actinomycetes. These have the simple cell structure of bacteria, but grow multicellular, hyphae-like filaments resembling fungi. Their enzymatic role is to degrade tough, resistant-to-rot woody stems and bark. Their gray-white filaments look “cobwebby” and have a pleasant, earthy smell. They can rot a redwood stake in the ground in 9–15 months.

When a pile has cooled and cured for 1–3 months, macroorganisms move in to finish the job. These organisms—mites, springtails, centipedes, millipedes, sowbugs, ants, nematodes, earthworms, etc.—are physical (as compared to chemical) decomposers. They use their mouthparts to chew, shred, and further break apart resistant materials, as well as feed on dead bacteria and fungi. In doing so, they also create a softer, more “open” substrate that can be re-colonized by bacteria and fungi, which break the materials down further.

Five Criteria for Success

What are the criteria for successful husbandry of a compost pile?

1. Pile Size and Dimensions

Conventional wisdom now states a minimum size of 5' x 5' x 5' is required for successful composting. But those working in small spaces shouldn't despair—ideal dimensions are about (maximum) volume to (minimum) surface area ratios. That is, a big pile has more internal mass and thus a more hospitable decomposition environment for the microbes involved. The bigger pile also features less surface area, as the ambient environment largely degrades the pile's surface.

Some tips on pile dimensions:

- Oxygen does not move passively more than 3–4' into a pile, so width should not exceed 6–8'.
- It is impractical (i.e., too much heavy lifting) to build a pile more than 4'–5' in height.
- Length is simply a function of the volume of material on hand.
- A cube-shaped pile is better than a pyramid or tapered haystack

2. Particle Size of Ingredients

The principle is the smaller the particle size (via chopping and shredding) the greater the surface area, the more the microbes can “occupy space” and thus the faster the rate of decomposition. Chopping plant material also breaks apart the rigid, often waxy outer cuticle of plants, making the succulent “innards” more accessible to the enzymatic and acidic secretions of bacteria and fungi, thus speeding and contributing to more thorough decomposition.

3. Aeration

As oxygen fuels the metabolism of the decomposers in a pile, the pile construction should feature adequate pore/air space. This is readily achieved by layering together an admixture of coarse materials and fine-chopped materials.

Once the process is underway (1–3 weeks) a pile will settle, losing 30–50% of its volume as the materials are physically broken down. At that juncture there is usually a sharp drop in temperature. As the pile settles, reducing pore/air space, and as microbial populations exhaust the oxygen supply, oxygen becomes a limiting factor. This is an opportune time to turn and re-aerate a pile. There is often a spike in temperature associated with turning: as oxygen is resupplied, microbial populations boom—the heat generated is a byproduct of their metabolism as they continue to break down materials in the pile.

4. Moisture

Compost pile ingredients should be about 40–60% moisture by weight. This equates to the consistency of a wrung-out sponge. It is best to apply water (sprinkle-spray, not drench) incrementally to each layer as you construct a pile. The moisture is for the microbes, but it also softens the pile ingredients. A note: as water will trickle down from top to bottom, apply less water to the lower layers of the pile. Also, as plants are merely supported columns of water (60–90% by weight), more water will be released into the pile as decomposition progresses. Thus, be conservative with the initial water application.

5. Carbon to Nitrogen Ratio (C:N)

The ideal C:N ratio at the outset is suggested as 30–40:1. This means the pile has 30–40 times more carbon-rich than nitrogen-rich material by weight. While all materials contain some carbon, carbonaceous materials (think “browns”: straw, leaves, wood chips, etc.) contain primarily carbon, and similarly, nitrogenous materials (think “greens”: fresh, lush plant material and animal manures)

feature a high nitrogen content relative to carbon.

What is important vis a vis C:N ratio is that this is the ideal proportion to fuel the diet of the pile's microbial decomposers. In essence, they use carbon to nitrogen in a 30–40:1 ratio.

Microbes use the carbon-rich ingredients as building blocks for cellulose and, as we do, for carbohydrates that fuel their work. They use the nitrogen to build proteins, amino acids, and enzymes that are necessary for cell growth, function, and reproduction. Enzymes are also key to the decomposition process; they act as biological catalysts, accelerating biochemical reactions and hastening the breakdown of organic matter. It is interesting to note that the enzymes produced by bacteria and fungi persist and function long after the producing organisms have died. In fact these same enzymes contribute to the breakdown of the “microbial corpses” that produced them.

You can achieve the desired 30–40:1 C:N ration by combining comparative volumes of carbon-rich (brown) and nitrogen-rich (green) ingredients in layers. A wide range of comparative volumes will work, from 50% carbon-based materials combined with 50% nitrogen-based materials, to as much as 80% nitrogen-based materials and 20% carbon-based materials. The pile higher in nitrogen will heat up more quickly, get hotter (130–150°F), stay hot longer, break down faster, and kill more weed seeds and plant pathogens.

In creating the “microbial layer cake,” thin, repeated layers work best. For example:

- C: 2” straw/leaves/wood chips, etc. (straw is a good absorptive material to use at the base of the pile)
- N: 2” kitchen scraps
- C: 2” straw/leaves/wood chips, etc.
- N: 6” fresh horse manure
- C: 2” straw/leaves/wood chips, etc.
- N: 4” greens
- C: 2” straw

Compost and soil organisms metabolize carbonaceous materials to get carbon for building essential organic compounds and to obtain energy. However, no organism can grow, function and reproduce on carbon alone. They also need a sufficient amount of nitrogen to make nitrogen-containing cellular compounds such as—

Amino acids and enzymes, used to decompose organic matter—especially carbonaceous materials	DNA	Structural proteins; e.g., bacteria's structural proteins make flagella, used for locomotion
--	------------	---

Soil microbes need to incorporate into their cells (on average) about 10 parts of carbon for every 1 part of nitrogen. Because only about 1/3 of the carbon ingested is actually incorporated into cells (the remaining 2/3 is respired and lost as CO₂), microbes need 30 parts carbon to 1 part nitrogen in their “feedstock,” or a 30:1 C:N ratio. Note that although various texts give differing “ideal” C:N ratios, from 20–40:1, we have found a 30:1 ratio most effective in hand-built compost piles.

Thus, a compost pile made with ingredients at a 30:1 C:N ratio provides microbes with a balanced diet that in turn enables them to thrive and reproduce and to decompose and digest the coarse material of a compost pile efficiently at the outset, and transform it into the fine, granular, soil-like product we call finished compost.

For more information on C:N ration see:

compost.css.cornell.edu/calc/cn_ratio.html

Repeat to height of 4'–5'

The pile would then feature 40% carbon-based materials and 60% nitrogen-based materials by approximate volumes and predictably, do quite well. Note that vegan, or non-manure piles, work fine. The value of animal manures is that they are both rich in nitrogen and microbes—a sourdough starter of sorts to jumpstart a pile.

Finishing

Your finished compost can be used both to fertilize plants and to improve soil structure. Before you work the soil (digging or forking), spread compost on the surface of your bed. Then as you dig it will be worked in uniformly to the depth you are working the soil. Typical intensive garden application rates are ½–2 pounds/square foot. This range is dependent on your present soil development and fertility.

SUPPLEMENT 2

Field-scale Compost Production at Phil Foster Ranches: A Case Study

Phil and Katherine Foster farm 295 acres of vegetables and fruits on two certified organic ranches in San Juan Bautista and Hollister (San Benito County, California). At peak season, they work with a crew of 55 employees to produce more than 60 different crops, which are direct marketed through ten regional farmers' markets and a popular roadside stand. Phil also sells to numerous retail stores, where the Pinnacle Organic brand is a familiar sight to shoppers from Carmel to the San Francisco Bay Area.

Phil Foster is regarded as one of the region's most successful and progressive organic growers, in large part because of the craftsman-like approach he takes to building and maintaining healthy soil. He's the first to say that the compost he uses in his operation, produced on his Hollister ranch, is one of the keys to the exceptional quality and abundance of Pinnacle Organic's produce (www.pinnacleorganic.com). Phil generously offered to share the story of his compost operation during a visit to the ranch in spring 2014.

Background

After working in the conventional produce industry in California's Central Valley, Phil started farming organically in 1988 (both his ranches are certified organic by the California Certified Organic Farmers, CCOF). He initially spread manure on his fields in the fall to replenish organic matter following the cropping season and ahead of the winter rains, then switched to buying in commercially made compost from New Era. After attending a seminar on the Luebke compost production method¹ (also referred to as controlled microbial composting) at the nearby Herbert Family Organic Farm, Phil started making his own compost at the Hollister ranch in 1995. The compost yard now covers 4 acres, where his compost crew produces 2,000 tons of finished compost annually, enough for all of both ranches' needs.

Labor, Machinery and Compost Yard Set Up

Originally, the operation used an 8' self-propelled compost turner and a Zeton spreader from Farmers Equipment. Phil has since switched to a used 10' Sandberger pull-behind machine upgraded by HCL Machine Works (www.compostturners.com) in Dos Palos, California, which he purchased for \$7,000 (new units run approximately \$20,000). He had the machine rebuilt with common drum bearings to make it easier to fix in-house.

Other equipment used in the operation includes:

- Tractor with creeper gear or hydrostatic transmission for pulling the compost turner. Phil's crew runs it with an 80HP orchard tractor or a 90HP JD6410. You need roughly 10HP per foot of compost (10' to 80-90 HP).
- Wheel loader for moving feedstock, building windrows, and loading finished compost (he purchased his used for \$10,000).
- Instruments to measure temperature, CO₂ production, microbial life levels (approximate cost \$500).

Other compost yard considerations:

- Access to a water source to wet down compost during turning. Pinnacle's operation uses a dedicated tank with a trickle-fill system at 5 gallons/minute, so as not to disrupt the irrigation system.
- Adequate space to accept deliveries of large loads of feedstock and to store finished compost
- Proper grading to shed water and prevent pooling.

¹ Read more about controlled microbial composting at www.herbertfamilyorganicfarm.com/Compost.html

Key to the operation is Pinnacle employees Manuel Estrada, who works with other staff to meet the feedstock deliveries, build the piles, run the compost turning equipment, and measure and record temperature, CO₂ production, and other factors as the piles mature. Employees who work in the compost yard also have other roles on the ranch, but Phil notes that the expertise Estrada has developed over the years is vital to the compost operation's success.

Feedstocks

The composting operation uses a variety of feedstocks to create the proper balance of carbon and nitrogen in the windrows:

- Wheat straw is often laid down as a “footing” for each windrow, using 65 bales per row (though it has not been used the past two years). With a 70:1 C:N ratio, it quickly decomposes. Phil notes that bales that have been rained on can be purchased at a discount.
- Greenwaste includes “fines,” or tub-ground vegetation from Vision Recycling in Santa Cruz County, which he cites as producing a high-quality product that offers an ideal 30–40:1 C:N ratio.
- A tree company provides a regular source of chipped wood and branches, another good carbon source.
- Cow manure is brought in from a dairy operation in Los Banos (a closer dairy that once delivered regularly recently shut down).
- Horse manure is delivered from local horse ranches.
- The farming operation generates a year-round source of “greens” for the piles in the form of culls, which make up 10–15% of each windrow by weight.

Timing

Pinnacle's compost operation kicks off in May, and during May and June the crew fills the yard with compost that will be finished August through September. They build more piles in October and November, before it typically becomes too wet to easily produce compost.

Once built, each 10'-wide x 400'-long windrow is turned every 2–7 days and requires about 16 weeks from building to finished material, during which time the volume shrinks by about half.

During the season the crew generates about 2,000 tons of finished compost for the two ranches (a trucking company trucks finished compost to the San Juan Bautista ranch); any piles left in the yard during winter are covered with breathable synthetic material to prevent leaching.

Temperature, Finishing, and Safety Considerations

The thermophillic (high temperature) stage is critical to the production of a safe, high-quality product. A properly built pile should heat to 130°–150°F for a minimum of 15 days, which requires turning the pile to reheat it by reintroducing air and water when it cools (note that National Organic Program regulations require the pile to be turned at least 5 times in a 15-day period). Turning reduces the temperature from above 150°F. In addition, if the temperature gets too high, clay soil can be added as a buffer. When finished, temperature in the pile drops to 80°F, CO₂ level decreases, and pH drops below 8.

To prevent cross-contamination, the compost turner, front end loader, and other equipment are thoroughly cleaned between turnings and between windrows, going from unfinished to finished piles. A hedgerow planted around the yard protects adjacent crops from windblown material and absorbs runoff from the site, and Phil avoids planting leafy greens around the yard to minimize any potential contamination issues.

In addition, each finished windrow is tested for *E. coli* and Salmonella. Phil also does a nutrient screening from 2–3 rows of finished compost each year to check N:P:K levels, as well as a microbial analysis to assess diversity and activity. In addition to meeting CCOF record-keeping requirements, the operation has also been inspected by the county health inspector annually.

Application Rate, Cover Crops, and Soil Organic Matter Levels

The ranches use about 10 tons/acre of finished compost mixed with gypsum in a 4:1 ratio (8 tons compost plus 2 tons gypsum). After bedding up, compost is spread using a manure spreader that matches the bed configurations (40" and 80") and worked in with a rolling cultivator prior to pre-irrigation.

In the orchards, compost is applied to every other row on top of a mowed cover crop using a

smaller manure spreader, then worked in with a spader.

In addition to compost applications, every field is planted with cover crops in spring, late summer, or fall at least every other year, although for the last two years cover crop planting has been significantly reduced at the Santa Ana Ranch due to the drought. The combination of regular compost applications and cover crops has raised the soil organic matter levels on the ranches from 2–3.5% when Phil started farming in the 1980s to the current levels of 5–6%—remarkably high by Central California soil standards.

Costs, Pros and Cons

Phil says it costs about \$35–\$38/ton to produce compost on site, including labor, feedstock, fuel, and equipment repairs, which is comparable to the cost of purchasing finished compost from a commercial source.

Even with the relatively equivalent costs, he sees a number of advantages in making your own compost versus “buying in,” including:

- The ability to control both the quality of inputs and the production process; that quality will show in improved soil health.
- Generating compost when you need it.

- Reducing farm waste products by using up culls; this also helps reduce levels of diseases and pests (e.g., maggots in culled onions).
- Spreading out costs over a longer time period.
- Having a known testing system in place in an ever-changing food safety regulatory environment.

Phil also acknowledges the drawbacks in running your own composting operation. These include:

- The up-front costs of buying the necessary equipment and ongoing labor, feedstock, fuel, water, and feedstock expenses.
- The learning curve involved—Phil says it took him 4–5 years to become fairly proficient at producing good quality compost—and the ongoing time commitment required for production and testing.
- Dedicating a portion of land to a compost yard.
- Issues with feedstock quality and availability.

If you decide to purchase compost from a commercial source, Phil recommends visiting the operation to assess the quality of the material and the practices used. Make sure the producer is approved by the Organic Materials Review Institute (OMRI, www.omri.org). Ask for records of inputs and practices, and get a nutrient analysis done.

SUPPLEMENT 3

Built on Compost—The Good Food Revolution at Growing Power

In 2008, the distribution of the world's population shifted for the first time from a rural to an urban majority.¹ That nearly 87% of the world's population was rural only 113 years ago puts the recent change into perspective. Interestingly, the U.S. population made the same transition much earlier, around 1920.

Rapid urbanization, compounded by globalization, has had lasting effects on the agricultural sector and on both urban and rural communities: As urban populations increase, they place more demands on a shrinking group of rurally-based food suppliers. And as the movement for locally-based food systems grows to address this and other food system problems, urban agriculture has become a focal point for discussion, creativity, and progress. Indeed, the production of food in and around densely populated cities bears much promise as part of any solution to food supply and access issues for urban populations.

Growing Power, Inc. (www.growingpower.org), a Milwaukee-based organization, exemplifies the way that urban agriculture can address some of the needs of rapidly growing urban communities, particularly those with poor, minority populations. Will Allen, Growing Power's founder—born to former sharecroppers in 1949—was drawn back to agriculture after a career in professional basketball. Aside from his love for growing food, he saw that the mostly poor, black community near his roadside stand in North Milwaukee had limited access to fresh vegetables or to vegetables they preferred. Confirming his observation, a 2006 study found that more diverse

What is Sharecropping?

Sharecropping was a Southern U.S. land-leasing system that replaced labor formerly done by slaves. After the Civil War, former slaves sought jobs, and former plantation owners sought labor. Without land of their own, many black laborers farmed land owned by whites for a share of the profit from the crops. Throughout the season, equipment and seeds were distributed on credit that was settled at the end of the harvest. High interest rates, unpredictable harvests, restrictive laws, and unscrupulous landowners and merchants kept black farmers in a cycle of debt that had to be paid the next season, tying them to the land in much the same way as slavery.

food options exist in wealthy and white neighborhoods than in poor and minority neighborhoods.²

Allen decided that he would serve this unmet demand by growing fresh food in the neighborhood where his customers lived and involve the community in the process. In 1993, long before urban agriculture bloomed into the movement it is today, Growing Power began.

The importance of equal access to fresh food cannot be overestimated. While ever more exotic fruits and vegetables from around the world stock health and natural foods stores in wealthy and predominantly white neighborhoods, poor and

1 United Nations Department of Economic and Social Affairs. 2008. UN expert group meeting on population distribution, urbanization, internal migration and development. New York, 21–23 January, 2008. www.un.org/esa/population/meetings/EGM_PopDist/EGM_PopDist_Report.pdf

2 Moore, Latetia V., and Ana V. Diez Roux. 2006. Associations of neighborhood characteristics with the location and type of food stores. *American Journal of Public Health*, 96:2: 325-331. www.ncbi.nlm.nih.gov/pmc/articles/PMC1470485/pdf/0960325.pdf

minority communities face fewer and less healthy food choices in the form of convenience stores, fast food restaurants, and disappearing supermarkets. This lack of access can lead to higher rates of diet-related illnesses (see Lecture 2 in Unit 3.2, Social Issues in Current U.S. Agriculture).

Growing Power has been working to create an alternative food system based on intensive fruit and vegetable production, fish raising, and composting, in order to make healthy food available and affordable to the surrounding community, and to provide community members with some control over their food choices. But as anyone who has initiated an urban agricultural project knows, fertile, uncontaminated land is often difficult to find in a city. Even if land with soil is available, most empty lots are in former industrial areas where toxic contamination often renders land unusable (see Supplement in Unit 1.11, Reading and Interpreting Soil Test Reports).

In Milwaukee, Growing Power sat on a lot with no soil and five abandoned greenhouses. Compost became the foundation for all of Growing Power's activities. The raw materials needed to produce it were in abundant and cheap supply in the city—food waste, brewery grains, coffee grounds, newspaper waste, grass clippings, and leafmold are all by-products of urban life destined, in most places, for the landfill. Businesses will often donate these materials to urban agriculture projects, saving the cost of garbage hauling services. Compost, and vermicompost in particular, also provides a renewable source of fertilizer that doesn't rely on fossil-fuel inputs and can itself be used as a growing media. With a healthy compost-based system, Growing Power discovered a low-cost, renewable, and easy-

to-duplicate solution to one of the biggest hurdles people face when growing food in cities.

Since 1993, Growing Power has grown in size and scope, starting gardens in Chicago as well as Milwaukee, and training centers in 15 cities, and including youth training, outreach and education, and policy initiatives in its mission. Interest in urban agriculture has also blossomed into a movement that includes commercial urban farms, scores of community farms and gardens, and educational gardens and training programs growing food and flowers and raising chickens, bees, goats, and other livestock for local consumption.

Urban agriculture has grown so rapidly in the last two decades that in 2012, the USDA granted \$453,000 to Penn State University and New York University for a nationwide survey of the “State of Urban Agriculture”³ with an eye toward providing technical assistance, evaluating risk management, and removing barriers for urban farmers. The federal government's interest in urban agriculture comes on the heels of state and local initiatives to encourage urban agriculture in numerous cities, including Milwaukee, Chicago, New York and San Francisco.

The driving force behind these initiatives and the urban agriculture movement as a whole has always been groups of committed individuals in urban communities in search of food, community, opportunity, security, and access. What makes the Growing Power model work is not just its innovative techniques and creative use of urban spaces, but the partnership with its neighbors who not only receive the program's services, but contribute significantly to its success.

3 Penn State News. Study to examine trends in urban agriculture. August 17, 2012. <http://news.psu.edu/story/147385/2012/08/17/study-examine-trends-urban-agriculture>

Appendix 1: Compost Time/Temperature Curve

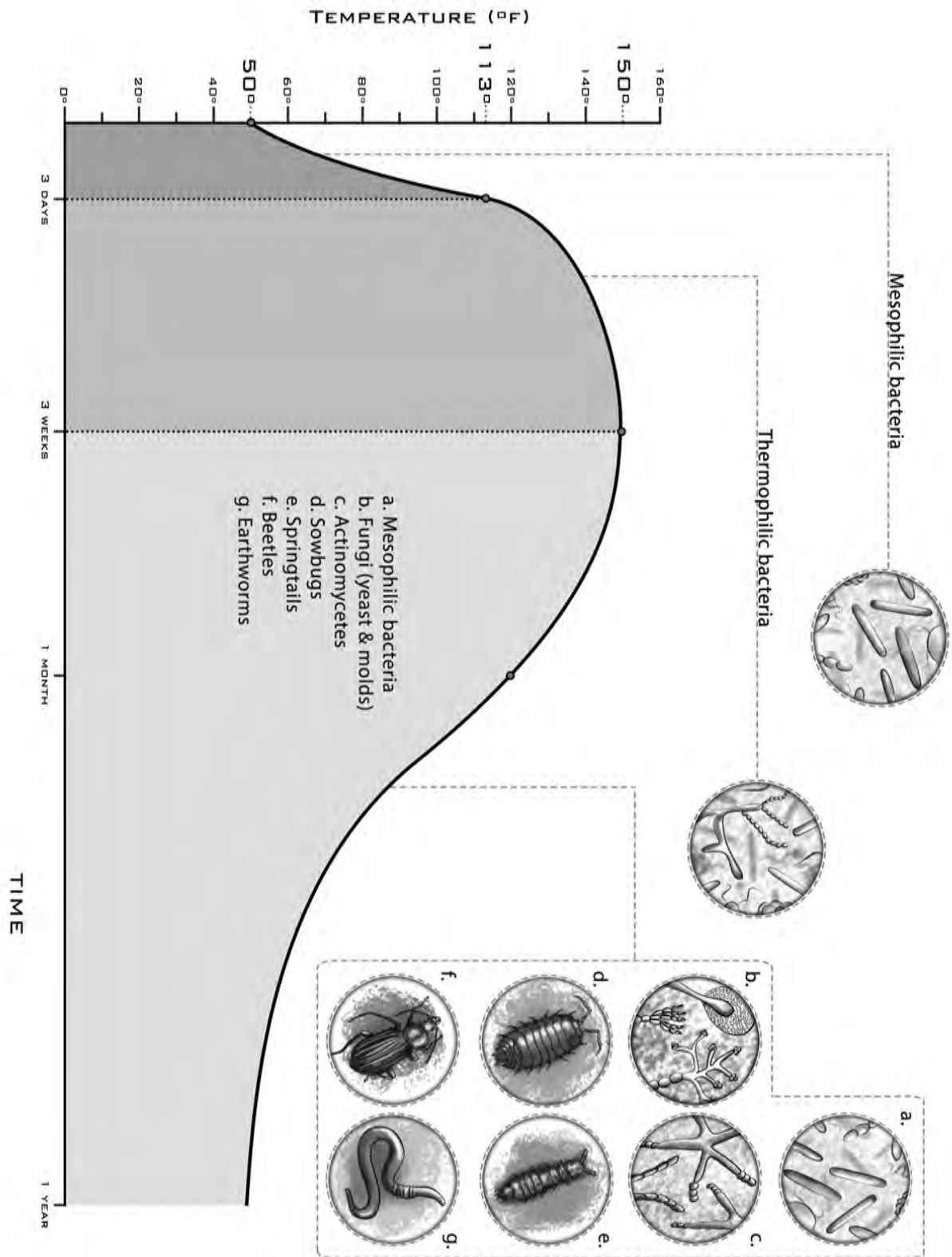

Appendix 2: Compost Food Web

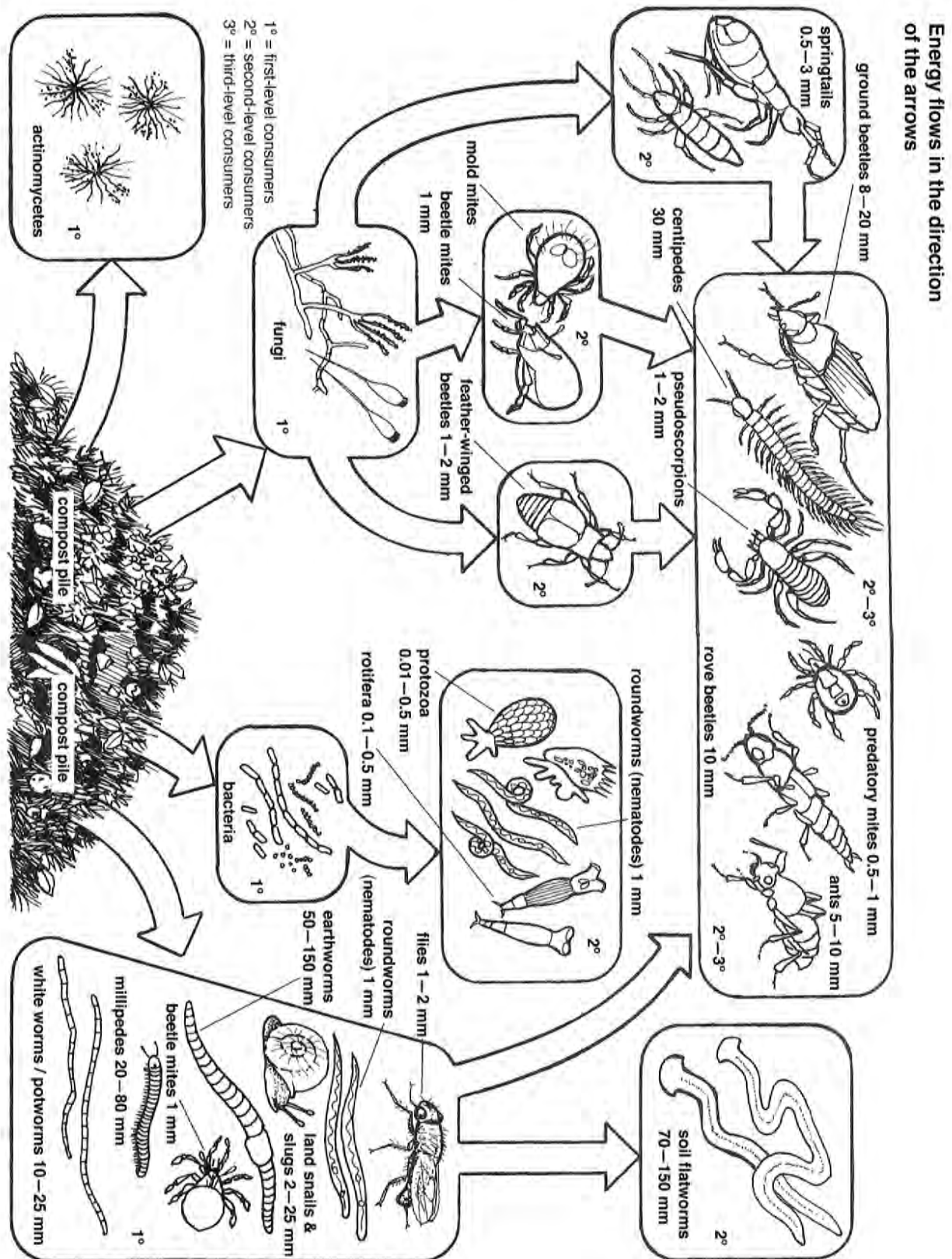

From the Rodale Book of Composting. Used by permission.

Appendix 3: C:N Ratio of Common Compost Materials

MATERIAL	C:N RATIO	
Fresh chicken manure (laying)	6:1	
Tomato processing waste	11:1	
Vegetable waste	12:1	
Alfalfa hay	13:1	
Fresh chicken manure (broiler)	14:1	
Sheep manure	16:1	
Fresh turkey manure	16:1	
Grass clippings	17:1	
Seaweed	19:1	
Fresh cattle manure	19:1	
Rotted manure	20:1	
Apple pomace	21:1	
Fresh horse manure	22:1	Optimum C:N range
Grape pomace	28:1	
Legume shells	30:1	
Cereal hay	32:1	
Dry leaves	40–80:1	
Corn stalks	50:1	
Oat straw	74:1	
Grain chaff and hulls (e.g., rice hulls)	80–120:1	
Straw	80:1	
Timothy hay	80:1	
Paper	170:1	
Newsprint, cardboard	400:1	
Sawdust	400:1	
Wood chips, shavings	500+:1	

From *Start with the Soil*, by Grace Gershuny. Used by permission of Chelsea Green Publishing Co.

Appendix 4: Calculating C:N Ratios for Compost —A Rough Guide

You have 5 pounds of grass clippings (C:N ratio = 20:1).

You have 5 pounds of leaves (C:N ratio = 40:1).

You have a total of 10 lbs. of material:

1/2 (50%) are grass, 1/2 (50%) are leaves.

Multiply the % of grass by the C:N ratio of grass, add the multiplication of the % of leaves by the C:N ratio of leaves:

$$(50\% \times 20/1) + (50\% \times 40/1) =$$

$$10 + 20 = 30 \text{ —> which in fraction notation is } 30/1 \text{ or } 30:1.$$

The C:N ratio is 30:1. (*Optimal C:N Ratio is 25–30:1)

Adapted from “Calculation of Carbon-to-Nitrogen Ratio (C:N)” by Master Composter, available online at www.mastercomposter.com. See also: compost.css.cornell.edu/calc/cn_ratio.html

Appendix 5: Compost Materials & Temperature Chart

NAME OF PILE: _____ BUILT BY: _____

DATE: _____

RAW MATERIALS (NAME AND DESCRIPTION) _____

CONSTRUCTION (SEQUENCE AND THICKNESS OF LAYERS) _____ DRAW YOUR PILE HERE:

APPROXIMATE FINISHED SIZE: _____

RECORD

DATE	TEMP °F	OBSERVATIONS + ACTIONS
_____	_____	_____
_____	_____	_____
_____	_____	_____
_____	_____	_____
_____	_____	_____
_____	_____	_____
_____	_____	_____
_____	_____	_____
_____	_____	_____
_____	_____	_____
_____	_____	_____

Appendix 5 (cont'd): Compost Materials & Temperature Chart

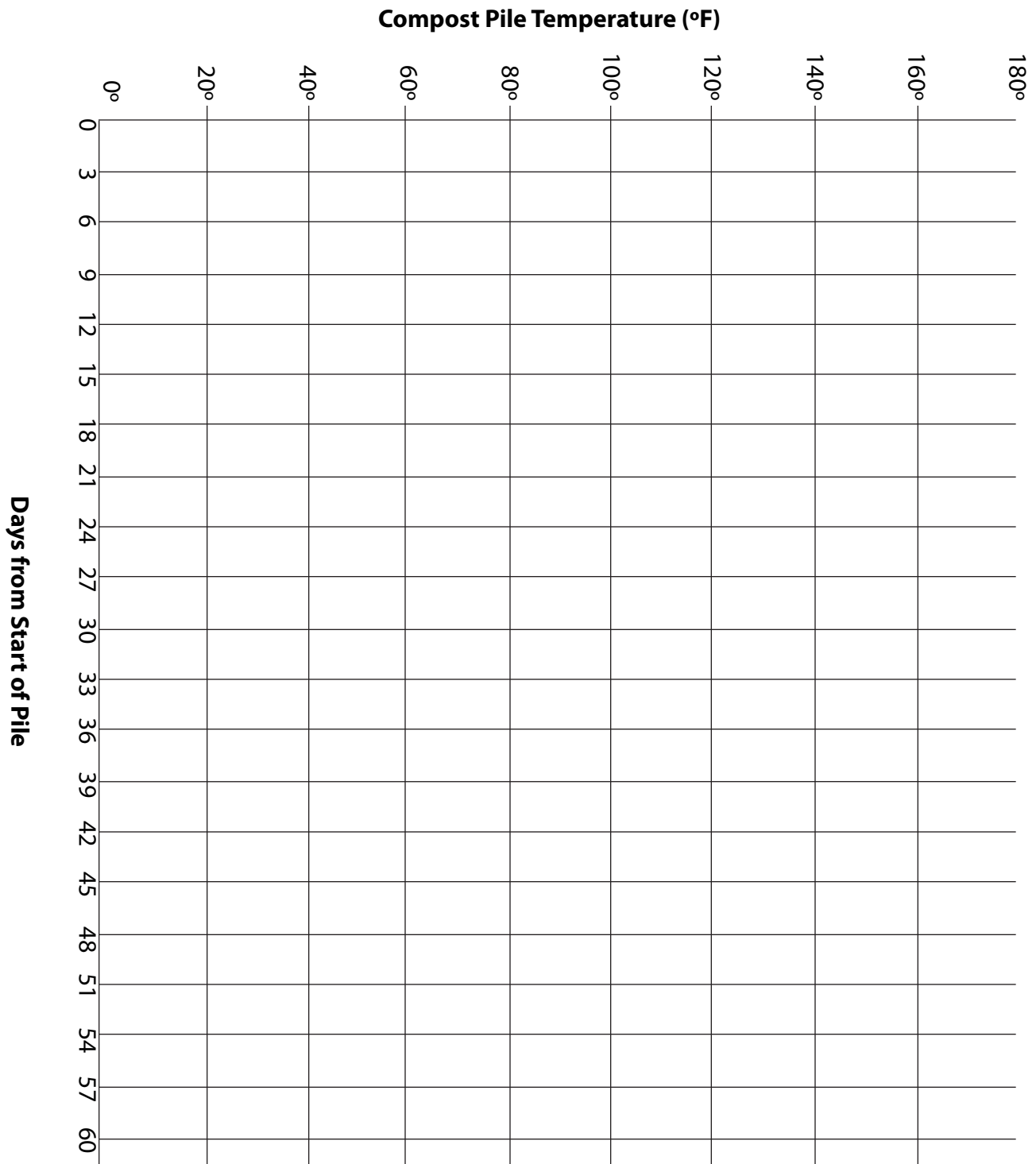

Arthropod Pest Management

Introduction	343
Lecture 1: Basic Biology and Ecology of Insects; Pesticides and Chemical Resistance	345
Lecture 2: Pest Management in Organic Cropping Systems	351
Demonstration 1: Insect Monitoring and Sampling	357
Demonstration 2: Insect Identification	359
Assessment Questions and Key	363
Resources	366
Appendix 1: Arthropod Pest Management Field Observations Record Sheet	369

Introduction: Managing Arthropod Pests

OVERVIEW

Although organic growers work to prevent or minimize pest damage, more direct treatment measures are sometimes required to prevent economic loss. This unit introduces students to the principles, practices, and skills used to manage beneficial and problematic arthropods within the standards set for certified organic production systems. Students will be encouraged to address arthropod pest problems in a manner that makes best use of local resources, and is compatible with certified organic production standards and an ecological approach to the design and management of agricultural ecosystems.

Lecture 1 introduces the basic biology and ecology of insects as they relate to identification for management purposes, including the concept of trophic levels, and introduces the issue of pesticide resistance. Lecture 2 discusses the components of a pest management program in organic farming systems, outlines basic arthropod monitoring procedures, and discusses specific practices used in sustainable production to prevent the growth of pest populations beyond economic thresholds. The design principles and practices used to enhance biological control through the use of non-crop vegetation are also introduced.

Through demonstrations, students will practice insect sampling, identification skills, and the use of online identification and diagnostic tools.

MODES OF INSTRUCTION

- > LECTURES (2 LECTURES 1.5 HOURS EACH; INCLUDES 0.5 HOUR FOR DISCUSSION, QUESTIONS AND ONE BREAK)
Lecture 1 introduces the basic biology and ecology of insects, includes the orders of insects most pertinent in agriculture, and discusses the issue of pesticides and mechanisms of chemical resistance
Lecture 2 discusses the importance of arthropod pest control, outlines principles and components of a pest management program, and contrasts preventive vs. suppressive control strategies.
- > DEMONSTRATION 1: INSECT MONITORING AND SAMPLING (0.5 HOURS)
Students will practice sampling techniques (hand-held vacuum, sweep net, beat-sheet, etc.) to collect insects from various crop plants.
- > DEMONSTRATION 2: INSECT IDENTIFICATION (1 HOUR)
Students will be provided with key taxonomic features to distinguish previously-collected insects of various orders, families, and feeding guilds. Corresponding feeding damage will also be displayed, when possible.
- > DEMONSTRATION 3: ONLINE TOOLS FOR (1 HOUR)
Students will practice using online tools to identify arthropods and diagnose arthropod damage, and to find information about alternative control options.
- > POWERPOINT
See casfs.ucsc.edu/about/publications, and click on Teaching Organic Farming & Gardening.

LEARNING OBJECTIVES

CONCEPTS

- Basic arthropod biology and ecology as they relate to management and classification
- Issues of pesticide use and chemical resistance
- The role of pest management in organic farming systems
- Farming and gardening practices that serve to prevent unchecked growth of pest populations
- Essential components of a sound pest management program for certified organic farming systems

SKILLS

- How to sample for arthropods
- How to recognize key pest groups and their damage symptoms
- How to recognize the basic groups of beneficial arthropods
- How to use IPM printed and on-line resources to determine control action thresholds
- How to evaluate a range of control measures available and their relative strengths and weaknesses

Lecture 1: Basic Biology & Ecology of Insects; Pesticides & Chemical Resistances

Pre-Assessment Questions

1. What are the major stages in an insect's life cycle?
2. In terms of pest management, what is meant by a "weak link" in the chain of an insect's life cycle?
3. What is a "trophic level"? Can you give some examples of different trophic levels?
4. What are some of the major orders of arthropods found on farms and in gardens?
5. Why are pesticides ineffective in controlling insect pests?

A. Basic Biology and Ecology of Insects

1. Taxonomy and taxonomic organization of insects
 - a) Example:
 - Kingdom (Animalia)
 - Phylum (Arthropoda)
 - Class (Insecta)
 - Order (Hemiptera = true bugs)
 - Family (Miridae)
 - Genus (Lygus)
 - Species (hesperus)
 - Common name = lygus bug
 - b) Currently, there are 26 orders in the class Insecta listed in the most widely used taxonomic textbooks. A general field entomologist, or someone working at an ecosystem level, will be looking to identify insects to the family level.
 - i. 659 families are listed for the U.S. and Canada
 - ii. The family level can often tell you a great deal about the biology of an insect. For example, all leafhoppers (family Cicadellidae) are plant-sucking herbivores.
 - iii. Similarly, all "hover flies" (family Syrphidae) are predators on other insects—especially aphids
 - iv. Variation within families: Even at the family level a great deal of variation can exist. For example, in the "shore flies" (family Ephydriidae) there is a range of species, some of which act as plant feeders, while others are detritus feeders (feeding on organic matter), and still others behave as predators and even as parasites.
2. Insect diversity
 - a) The number of described insect species
 - i. Example: There are over 250,000 described species of Coleoptera (beetles)
 - ii. The vast majority of insect species have yet to be described. This is especially true in the tropics, where only a small fraction of species has been formally studied.
 - b) Estimates on the number of insect species yet to be described
 - i. Anywhere from 2-100 million, although frequently estimated at about 30 million. Not surprisingly, much of this untapped knowledge lies in the tropics, where at least 6-9 million species have yet to be described.
 - c) Raw abundance: E. O. Wilson estimates there are 10 quintillion (10^{18}) insects in the world

3. Insect anatomy and development

- a) Three body segments: head, thorax and abdomen
 - i. Each segment responsible (primarily) for collecting sensory stimuli, movement and respiration/digestion/reproduction, respectively
- b) Metamorphosis
 - i. Insects grow by shedding their exoskeletons (molting), revealing a new, soft “skin” underneath that rapidly hardens into the next (larger) exoskeleton. Most insects go through several such molting stages before finally molting to the mature adult form.
 - ii. “Primitive” metamorphosis: Very early insect groups and proto-insects such as collembolans exhibit a “primitive” metamorphosis, in which adults differ from juveniles only in that they are larger and have sex organs
 - iii. “Incomplete” metamorphosis (hemimetabolism): Somewhat more recently evolved insect orders, such as the grasshoppers and crickets, preying mantids, termites, planthoppers and true bugs exhibit “incomplete metamorphosis”, in which juveniles look very much like adults, except for size, and the presence of sex organs and wings during the adult phase of the life cycle
 - iv. “Complete” metamorphosis (holometabolism): The most recent evolutionary development regarding insect maturation made a radical shift in strategy— one that ended up being highly successful. Insect orders that exhibit complete metamorphosis (e.g., beetles, flies, ants, and butterflies) are able to manifest entirely different body forms between sexually immature and mature stages.

4. Life stages and their relevance to pest management

- a) When we find an insect, what we see is only a snapshot of its entire life. One tactic in seeking a solution against a specific insect pest is to look for the “weak link” in the chain of its life cycle. (See Resources for a list of technical books on life cycles.)
 - i. Eggs: Insect eggs constitute a “weak link” for insect pests. Because they are stationary and lack an effective defense system, eggs offer an easy target for many predators, parasitoids, and parasites.
 - ii. Nymphs: The immature stages of insect orders having incomplete metamorphosis (e.g., grasshoppers and true bugs) are called nymphs. Nymphs often look similar to their adult stage (usually just missing the wings and sexual organs, but often different colors as well). Similarly they are often found in the same location, and exhibit the same feeding behavior as adults. As nymphs cannot fly and often lack structural defenses, they are also a preferred target for pest management programs.
 - iii. Larvae: The immature stages of insect orders exhibiting complete metamorphosis (e.g., butterflies, flies, and wasps) are called larvae. Larvae look nothing like their adult counterparts and are adapted for entirely different functions. Larvae are often difficult for all but an expert to identify. One tactic you can employ if you find an unknown larva attacking your garden is to conserve the larva, together with its fruit or vegetable meal, in a cloth-covered container for later identification as an adult. While larvae can possess structural (spines) or chemical defenses, their poor mobility makes them a good life stage to target for control. For instance, parasitoids often effectively seek out larvae for egg-laying, and some of the most effective and selective OMRI-approved materials (approved for use in certified organic systems) target pestiferous larvae.

- iv. Pupae: For the orders that undergo complete metamorphosis, the larva must make a radical transformation from larva to adult. To do so requires more than a mere shedding of the skin; this process is usually accomplished by creating some kind of protected resting stage (e.g., spinning a cocoon) and then spending days or weeks undergoing metamorphosis. During this resting stage, pupae are mostly defenseless from attack by predators and parasitoids, and pupal mortality can be significant. As the pupal stage lends itself to a resting stage, many holometabolic insects choose the pupal stage as a convenient way to pass a long, cold winter or a hot, dry summer (where in both cases there may otherwise be no food for the insect). This resting stage is termed a physiological “diapause”. Diapause can often be a convenient “weak link” for controlling insect pests, as many insects burrow into the ground to undergo diapause.
 - v. Adults: This life stage is often the least desirable with respect to targeted pest management: Greater mobility (via flight) and improved structural defenses make adults difficult to manage. Pheromone traps are one important exception, however, as they target adults seeking out reproductive opportunities.
5. Basic ecological categories: From a practical perspective, one of the best ways to categorize insects you find in the field is by how they live; principally, how and what they eat, and where they are found. This can sometimes be seen right away by a non-specialist, but with a little training and experience a majority of insects can be classified by their ecological role.
- a) Trophic levels: The term “trophic” can be thought of as “feeding level” in a hierarchy. At the first level are the producers (plants and other chlorophyll-bearing organisms). The second level consists of the herbivores (vegetation eaters), followed by the carnivores in the broadest sense, who can themselves be separated out into different levels, depending on who eats whom. The scavengers are organisms that consume dead and decaying organic matter. For our purposes we can borrow from the trophic-level concept to create five useful categories:
 - i. Herbivores: Almost every “pest” on the farm is an herbivore. Even herbivores that we easily identify as pests, such as spotted cucumber beetles, are only truly pests if their numbers are above an economic threshold for the farmer, i.e., when the financial loss caused by a pest surpasses the cost of pest control.
 - ii. Predators: Predatory insects and spiders kill and consume their prey, and tend to be “generalists.” That is, they have a fairly wide scope of arthropod prey, both pest and beneficial, that they can feed on.
 - iii. Parasitoids: Parasitoids are defined as insects that lay eggs inside the eggs or bodies of other insects. These eggs hatch and the emerging larvae consume the “host” insect, eventually killing the host and emerging as a free-living adult. The difference between a “parasite” and a “parasitoid” is that the parasite (e.g., a flea or a tick) does not directly kill the host. The difference between a predator and a parasitoid is that the predator directly kills and eats the “prey,” whereas in the case of the parasitoid, it is the next generation or offspring that actually does the killing. Parasitoids are mostly restricted to several dozen families of small to minute wasps, although there are several parasitic fly families as well. Parasitoids have been a favorite subject for biological control programs because they tend to be highly specific for one or a few species of host, and therefore can be used to target specific pests. Predators are generally better at reducing large numbers of pests, while parasitoids—because of their highly host-specific nature—are generally better at preventing populations of a pest from reaching high numbers in the first place. A coordinated strategy of using predators and parasitoids may be most effective in reducing and maintaining pest populations.

- iv. Hyperparasitoids: Hyperparasitoids are parasitoids of parasitoids
- v. Scavengers, also called “detritivores”: Insects that consume dead animal or vegetable material as the first phase in the decomposition of organic matter. Scavengers are found everywhere on an organic farm, but are often mostly absent in commercial farms where little organic matter is returned to the soil, and where toxic chemicals are commonly used.

Scavengers can also play an important role as alternative food sources for generalist predators, a potentially important relationship that has been mostly overlooked by conventional agronomic science.

- b) Functional groups: Functional groups are a non-definitive but quick and easy means of categorizing insects based on the farmer or gardener’s experience of what insects in their system do. This may give the practitioner a more “fine grained” description of his or her agroecosystem. Categories for functional groups commonly involve some, but usually not all of the following: Where an insect lives, its trophic level, how it feeds or what it feeds on, and some reference to a taxonomic label. Some examples include: “brassica-feeding beetles,” “egg parasitoids,” “aphid parasitoids,” “stem-boring moths,” “hunting spiders” and “web spiders.” You’ll find that defining a list of functional groups for the commonly found insects in your small farm or garden gives you around 15–20 different categories. This is just about the right size for properly defining the system without getting lost in non-intuitive names.

B. Pesticide Use and the Mechanisms for Chemical Resistance

1. Insects—selected orders
 - a) Grasshoppers and crickets (Orthoptera)
 - i. Almost always herbivorous, although often not numerous enough in California to be considered “pests”
 - b) Planthoppers, leafhoppers, aphids, scale, and mealybugs (Homoptera)
 - i. Always herbivorous, often pestiferous, sometimes vectors for fatal plant pathogens
 - c) True “bugs” (Hemiptera)
 - i. Herbivorous, carnivorous, and omnivorous, these bugs play important roles in both creating and preventing crop losses in agriculture
 - d) Flies (Diptera)
 - i. Some flies are serious pests (e.g. fruit flies), while others are important predators or parasitoids
 - e) Butterflies and moths (Lepidoptera)
 - i. Always herbivorous and can be pestiferous as larvae
 - f) Beetles (Coleoptera)
 - i. As beetles occupy nearly every terrestrial niche, they play important roles in both creating and preventing crop losses in agriculture
 - g) Bees and wasps (Hymenoptera)
 - i. While often helpful as parasitoids, some hymenopterans (e.g. ants) can also be problematic by protecting homopteran phloem-feeders
2. Arachnids
 - a) Spiders (Araneae)
 - i. Tremendous (and often underappreciated) generalist predators
 - b) Mites (Acari)
 - i. Large herbivorous mite populations can be problematic and are mitigated by predatory mite species

C. Pesticide Use and the Mechanisms for Chemical Resistance

1. Pesticide use rate in California: 173 million lbs. pesticide applied in 2010 (CDPR 2011)
2. Ineffective long-term control of pests with agricultural chemicals
 - a) Development of genetic resistance in pest populations
 - i. Natural selection in pest populations favors alleles (one of two or more alternative forms of a gene) that express resistance, remove alleles that promote susceptibility
 - ii. Herbivorous insects have co-evolved with the defensive compounds produced by plants. Consequently, these insects have developed very efficient mechanisms for breaking down potentially harmful chemicals, which leads populations toward resistance. Repeated exposures to the same chemical (or chemical class) accelerate this process.
 - b) Insecticide—induced resurgence due to disproportionate mortality of predaceous natural enemies
 - i. In general, predacious insect populations do not have the ability to express resistance to the same extent as their prey. Consequently, predators are eliminated from cropping systems at higher rates than herbivores. Predator population re-establishment is then hampered by the need for adequate prey, which means that in a disturbed system, pest resurgence is often a prerequisite for restored predator abundance.
 - c) Reduced efficacy leads to increased insecticide application rates
 - i. Due to insecticide resistance and/or predator removal, late season insecticide applications may become more frequent or more concentrated to maintain comparable levels of pest management.
 - d) While there is no doubt that insects cause significant losses to farms and gardens, it is also increasingly clear that much more attention is given to insects as “pests” than is often warranted by the evidence
 - i. This is in large measure due to the fact that multi-national chemical companies have enjoyed decades of profits from chemical insecticides on the order of \$35 billion per year, and in order to justify their continued profit taking—at the expense of the health of ecosystems and millions of people—insect pests need to be sold as “serious threats,” even when they might not be so
 - ii. Example: Research on tropical rice shows that the current \$3 billion/year industry in rice insecticides could conservatively be reduced by more than 95% without any increase in losses (Bill Settle, pers. comm.). In fact, the evidence shows insecticides cause pest outbreaks more than they prevent them (Bill Settle, pers. comm.).

Lecture 2: Pest Management in Organic Cropping Systems

Pre-Assessment Questions

1. Why is the management of arthropods important in crop production?
2. What would be the best ways to monitor for pests in the garden and small farm?
3. What is an economic threshold level?
4. What are several different organically acceptable ways to actively control pests?
5. Why are organic systems considered more resilient when it comes to resisting pest and pathogen outbreaks?
6. What would be some of the components of a sound pest management program for a certified organic farm or garden?

A. Why Management of Arthropods Is Important in Crop Production

1. Reduced productivity/yield: Unchecked growth of pest populations of plant-juice-sucking insects may lead to reductions in crop vigor, size, visual aesthetics, and overall yield
2. Spread of plant pathogens: Arthropods may create points of injury in plant tissues that allow fungal, bacterial, and viral diseases to successfully attack the plant. This is particularly important in perennial fruits and vegetables (e.g., Pierce's disease).
3. Reduced visual aesthetics of crop: Directly feeding on the crop (fruits, vegetables, or flowers) reduces the visual aesthetics, thereby rendering the crop unmarketable
4. Death of crop plants: Certain arthropods that feed on root systems of crops can cause death of the plants
5. Build up of pest populations: The absence of management may lead to the build up of pest populations, eventually causing increased crop losses in subsequent years

B. Components of a Pest Management Program

1. Identifying pests and understanding the ecology of agronomically important arthropods
 - a) An understanding of how environmental conditions affect populations of both pest and beneficial arthropods will help a grower make effective management decisions
 - i. Key pest: An herbivore that is consistently present, and if not managed, likely to exceed economic thresholds
 - ii. Secondary pest: An herbivore that is often present but rarely exceeds economic thresholds due to naturally-present predation and parasitism. An important exception is where broad-spectrum insecticides have reduced or eliminated these top-down controls. In these instances, secondary pests become very problematic.
 - iii. Occasional pest: An herbivore that may cause problems once every few years; only occurs when environmental conditions strongly favor their development
2. Monitoring for presence and abundance of insect populations and damage
 - a) Regular and systematic field assessments provide essential information on the status of the crop in relation to populations of pests and natural enemies. These assessments are critical for accurate Economic Injury Level (EIL)-based decisions (see more on EIL, be low).
3. Monitoring methods commonly used
 - a) Visual inspection/observation: Regular visual inspection and observation of plants in field and lab is the most effective monitoring method for small growers

- b) Pest-specific monitoring and sampling procedures for the garden and small farm (see Flint 1998)
 - c) Larger-scale monitoring and sampling: See anrcatalog.ucdavis.edu/ for a listing of IPM manuals for crop-specific monitoring and management
 - d) Arthropod sampling techniques for the garden and small farm
 - i. Traps: Less effective as they tell what is on the farm and not necessarily what is affecting the crops. Traps may also catch arthropods that come from outside the farm or garden.
 - Pheromone traps: Attract specific insects by chemical lure
 - Sticky traps: Capture flying adult insects
 - Light traps: Select for nocturnal insects
 - Pit fall traps: Capture ground-dwellings arthropods and spiders
 - ii. Collection: Most effective in determining abundance and correlating arthropods with crop damage
 - Sweep nets: Use to capture insects on vegetation
 - Aspirators: Use to capture very small insects on vegetation
 - Shaking plants: Shaking or beating plants or branches onto paper for later sampling is a useful way to gather insects for identification that might normally go unseen
 - iii. Degree-day monitoring: For some pests and beneficial insects, researchers have created temperature development thresholds at which time management actions may best be taken
4. Monitoring protocol for in-field visual inspections
- a) Survey crops systematically and on regular basis
 - i. Frequency: 1x/week; 2x/week during peak growing season
 - ii. Vegetable crops:
 - Walk furrows and check both sides of leaves every few plants
 - Remove wilted plants and examine root system for indications of soil borne insects, pathogens
 - Root crops: Check the soil before you plant by running your fingers through the soil (down to 4") looking for small insects. Collect and identify samples (rear pupae to adults if necessary).
 - iii. Orchards
 - Check trunk for injury (e.g., sap oozing from wounds)
 - Check fruit for scars or points of entry
 - Check interior of grounded fruit for pest presence
 - Examine both sides of leaves on each side of the tree
 - b) Assess and record the following (see Appendix 1, Arthropod Pest Management Field Observations Records Sheet):
 - i. Date, time, crop, and weather conditions
 - ii. Determine whether proper cultural care is being delivered (e.g., water, weed control)
 - iii. Number of pests observed
 - iv. Amount and type of damage (see below)
 - v. Presence and numbers of beneficials/natural enemies
 - vi. Evidence of parasitism or predation of pest organisms
 - vii. Stage of crop development

5. Management procedures
 - a) Determine if control action/economic threshold has been exceeded (see below)
 - b) Research control action options
 - c) Implement control actions
 - d) Document control actions taken and responses to treatment
6. Identifying types of pest-induced damage
 - a) Direct damage: Marketable portion of the crop is negatively affected. Very little direct damage (from feeding, frass, egg-laying, etc.) is acceptable, in most cases. As a grower, it's vital that you are familiar with your customer base and their tolerance level for such damage. This varies greatly from one customer base to another (e.g., grocery store shoppers will have a vastly different idea of what's acceptable, when compared with a typical CSA member).
 - b) Indirect damage: Portions of the crop that are not marketed are fed upon—roots, leaves, stems, etc. The ability of indirect damage to negatively affect yield varies significantly by crop and growth stage. Some indirect feeding is often tolerable. Vectors of plant pathogens should not be considered typical producers of indirect damage, as their feeding often influences yield.
7. Defining economic injury level (EIL) or economic threshold
 - a) A crop's EIL helps a grower determine the point at which a pest population causes enough damage to justify the time and expense of active control measures
 - b) This threshold is exceeded when the financial loss caused by the pest surpasses the cost of pest control
 - c) Alternatively, control action thresholds could be defined as a point in time when an action must be taken to avoid additional crop damage
 - i. This decision-making process relies heavily on documenting natural enemies to determine when yield reductions are otherwise unavoidable. For instance, there are no signs of predatory eggs or parasitized pests.
8. Searching for, and developing, crop-specific economic thresholds (see www.ipm.ucdavis.edu; Flint 1998)
 - a) Quantitative control action thresholds exist for some but not all crops and pests
 - b) For those crops without control action thresholds, growers must determine thresholds themselves through observation, trial and error
 - c) Established control action guidelines do not include the influence of beneficial insects and spiders, and therefore often require adjusting
 - i. For example, the (unofficial) allowable pest density in organic strawberries for lygus bugs is more than double the acceptable density in conventionally-managed strawberries
 - d) The use of records from previous seasons documenting pest and beneficial insect densities will help determine the need for treatments
 - e) General rule: Any time you find a lot of one type of pest insect (more than 5 on 2–3 plants in a row with no predators found in that same area) the pest/beneficial ratio is out of balance and some outside control will be necessary (Bill Settle, pers. comm.)
9. Temporal pest management considerations
 - a) When are pests capable of causing economic damage? Depending on the crop, herbivores may not be capable of causing "damage" during the entire crop cycle, but only during certain developmental windows. Actionable decisions should only be made pertaining to these periods of susceptibility.

- b) What temporal requirements do relevant beneficial insects have and how does this influence a crop's EIL? For instance, many species of female syrphid fly will only lay eggs once a prey-density threshold has been exceeded (e.g., approximately 50 aphids/broccoli plant), which usually takes 3-4 weeks. Consequently, early aphid arrivals that promote an accelerated syrphid response should be welcomed, and not treated with insecticide.

C. Integrated Pest Management for Certified Organic Farming Systems

1. The definition of integrated pest management (IPM) stresses pest prevention. Instilling preventative mechanisms into an agroecosystem is particularly relevant to organic farming for two reasons: First, properly managed organic systems have the potential for tremendous resiliency towards pests and pathogens that help prevent these outbreaks from occurring. Second, organic growers do not have the "tools" to suppress pest outbreaks that their conventional counterparts possess.
 - a) Pest avoidance is the first step towards prevention
 - i. Temporal avoidance, e.g., by isolating a vulnerable crop stage from a period of heavy pest pressure either by planting during a pest's "off season" (if possible) or by using degree day models to forecast a pest's arrival. For instance, when possible, harvest corn prior to the arrival of the corn ear worm, which can be anticipated through degree day accumulations and records of previous growing seasons.
 - ii. Spatial avoidance, e.g., by avoiding regions or crop/landscape configurations with especially high pest pressure. For instance, as native vegetation is a reservoir for certain fruit flies, avoid planting adjacent to forest edges. Alternatively, crop rotation relocates specific crops to prevent pests from becoming spatially concentrated and is particularly relevant for minimizing levels of soil-borne pests (e.g., cabbage maggot), sessile feeders (e.g., aphids, scale, etc.) and soil pathogens (e.g. Verticillium wilt). Rotating a cole crop (e.g. broccoli or kale), which is resistant to Verticillium wilt, into a space after a Verticillium wilt-susceptible crop (e.g. strawberries or lettuce) was grown is one such example.
 - iii. Physical avoidance, e.g., row covers, plastic mulch and fences can all act as physical barriers that prevent pest access. These exclusion techniques are often used during periods of high plant susceptibility. For instance, row covers protect young transplants that are especially vulnerable to defoliators, such as flea beetles.
 - b) Field sanitation to remove pest habitat and reduce reproductive opportunities
 - i. Depending on the crop, remove fruit, fully disk and incorporate crop residue, and manage weeds to reduce habitat for pests. This is especially true for pupae, which can use these micro-habitats to overwinter in your field and emerge earlier than expected during the next cropping season.
 - c) Sound soil fertility management and nutrient budgeting (see also Unit 1.1, Managing Soil Health, Unit 1.6, Selecting and Using Cover Crops, and Unit 1.11, Reading and Interpreting Soil Test Reports)
 - i. Soil organic matter management: Regular additions of organic matter (e.g., compost, cover crops, and/or manure) stimulate soil biological activity and diversity, which may prevent certain pest populations from increasing beyond economic thresholds
 - ii. Nutrient budgeting, soil amending, and supplemental fertilizing: Designing efficient amendment and fertilization plans around crop nutrient requirements and avoiding unnecessary nutrient inputs may prevent pest problems associated with both nutrient deficiencies and excesses

2. Suppressive measures

a) Pheromones

- i. The chemical sex attractant used by many insect species to draw mates
- ii. Trapping out: The use of pheromone traps to trap and kill
- iii. Mating disruption: The timed mass release of synthetic pheromones with the mating times of agricultural pests resulting in the inability of mating pairs to form
Pheromone dispensers, often in the form of twist-tie dispensers attached to plants or caneberry hedgerow wires, emit large doses of female attractant to chemically saturate an area, such that male moths are unable to locate females and reproduce. Examples include codling moth pheromone in apples, light brown apple moth pheromone in strawberries, and leafroller pheromone in caneberries (in these cases, hundreds of twist ties are applied per acre).

b) Habitat management examples

- i. Farmscaping: Managing or manipulating agricultural landscapes to positively affect insect trophic interactions and thereby reduce subsequent crop damage. These techniques improve the ability of predators and parasitoids to maintain pest populations below damaging levels, direct pests away from cash crops by utilizing behavioral traits, and generally seek to create systems that are more robust (i.e., less prone to crop damage), often without additional chemical inputs.
- ii. Trap crops: Incorporating plants to attract key pests away from cash crops and into small spatial concentrations, where they can be removed via cutting, vacuuming, or insecticide application. Successful examples of trap cropping include alfalfa added to cotton and strawberry for lygus bug control, cherry pepper added to bell pepper for pepper maggot control, and squash added to watermelon for squash bug control.
- iii. Beneficial insectary habitats: Incorporating plants to provide predators and parasitoids with floral resources that would otherwise be lacking, and thereby improve their ability to reduce pest pressure in the cash crop. E.g., sweet alyssum is often planted as an intercrop with lettuce and cole crops to improve the fecundity of syrphid flies, whose offspring devour aphids. Hedgerows, which are stands of flowering perennials (often native plants) established adjacent to cultivated lands, are also used to provide floral resources to beneficial insects and pollinators.

c) Biological control (BC) may be defined as “the actions of parasites, predators and pathogens in maintaining pest density at a lower average population density than would occur in their absence”

- i. Classical BC: The introduction and intended establishment of highly specialized herbivores, predators, and parasitoids to manage pest populations. Classical BC is often used for newly established exotic insect pests that lack predation and parasitism in their new habitat.
- ii. Conservation BC: Efforts to create habitat-based conditions that allow for optimal biological control of naturally-occurring parasitoids and predators. These conditions include floral resources, overwintering habitat, alternative host material, a lack of insecticide applications, etc.

- iii. Augmentative BC: includes inoculative BC, in which natural enemies are released when pest populations are low, giving the natural enemies enough time to develop with the pest population. Inoculative BC relies on subsequent generations to manage the target pest. As the released natural enemies are not necessarily adapted to the release environment populations, releases (inoculations) are made at the start of each growing season. Inundative BC is also used and relies on mass releases of natural enemies to control a large population of target pests that are causing damage close to the economic threshold. Relies on sheer numbers and periodic and seasonal releases to suppress a given pest population.
- d) Mechanical control
 - i. Examples include row covers, solarization, vacuums, traps, flooding, and tillage
- e) Insecticides
 - i. Botanicals: Plant derivatives; e.g. pyrethrum (from *Chrysanthemum*) or Azadirachtins (from the neem tree)
 - ii. Soaps and oils: K fatty acids used for soft-bodied insects (e.g. M-pede®)
 - iii. Microbials: Mass-produced entomopathic micro-organisms (often bacteria); e.g. Bt or Entrust® (from *Saccharopolyspora spinosa*)

*Note: To meet organic certification requirements, materials must be in compliance with National Organic Program (NOP) standards. A complete list of brand names and generic materials allowed under certification is available from the Organic Materials Review Institute (OMRI) at www.omri.org.

Demonstration 1: Pest Monitoring & Sampling

for the instructor

OVERVIEW

This demonstration introduces students to the principles and practices of pest management and field monitoring for the garden and small farm. The act of collecting insects serves as a valuable exercise, as it familiarizes the participant with 1) various collection techniques, 2) an idea of how much effort is required to adequately search or scout for a particular insect, and 3) a firsthand experience of the countless insects thriving in a world that is rarely apparent to passersby.

Using the demonstration outline, the instructor should review with students the basic steps in visually monitoring different types of crops and documenting the presence and abundance of insect pests, pest damage, and beneficial arthropods. Following this, the instructor introduces several field sampling techniques commonly used in pest management monitoring on small farms and gardens. Then ask students to collect samples of crop damage and arthropod samples using sweep nets and aspirators, and retrieve insect samples from previously placed traps. Samples will be used in Demonstration 2 to practice insect identification (note that they can be frozen for later use).

PREPARATION AND MATERIALS

- Gardens or fields with actively growing crops
- Insect traps (pitfall or yellow sticky traps placed in several field/garden locations several days prior to instruction)
- Sweep nets
- Aspirators (bug-vacs)
- Beat sheets
- Film containers (for insect samples)
- Alcohol (for insect samples)
- Ziploc bags (for storing samples in freezer)

PREPARATION TIME

1 hour

DEMONSTRATION AND DISCUSSION TIME

1 hour

DEMONSTRATION OUTLINE

A. Review Monitoring Protocol for In-field Visual Inspections

1. Surveying crops systematically and on regular basis
 - a) Frequency: 1x/week; 2x/week during peak growing season
 - b) Time of day to sample
 - c) Vegetable crops
 - i. Demonstrate walking furrows and checking both sides of leaves on every few plants
 - ii. Demonstrate removing any wilted plants and examining root system for indications of soil borne insects or pathogens
 - d) Orchards
 - i. Demonstrate checking trunk for injury (e.g., exuding sap)
 - ii. Demonstrate checking fruit for scars or points of entry
 - iii. Demonstrate checking interior of grounded fruit for pest presence
 - iv. Demonstrate examining both sides of leaves on each side of the tree
2. Review record keeping procedures, including the following (see Appendix 1, Arthropod Pest Management Field Observations Records Sheet)
 - a) Date, time, crop, and weather conditions
 - b) Is proper cultural care being delivered (e.g., water)?
 - c) Number of pests observed
 - d) Amount and type of damage
 - e) Presence and numbers of beneficials/natural enemies
 - f) Evidence of parasitism or predation
 - g) Stage of crop development
 - h) Management actions taken

B. Demonstrate Sampling Procedures

1. Sweep nets
2. Pitfall and/or yellow sticky traps
3. Aspirators
4. Beat sheets
5. Hand picking
6. Preservation in alcohol and Ziploc bags
7. Sampling damaged plants

Demonstration 2: Insect Identification

for the instructor

OVERVIEW

In this demonstration, students will practice identifying previously-collected insects (see Demonstration 1) and associated insect damage using taxonomic characteristics and other resources to distinguish previously-collected insects of various orders, families and feeding guilds. Knowing these distinctions is important to farmers and horticulturalists because it improves the accuracy of field scouting and the quality of decision making. Understanding insect taxonomy also provides a great way to appreciate and gauge the biological diversity on one's farm. When possible, feeding damage that corresponds with collected insects should also be displayed.

Working in small groups in a laboratory setting, students will review specimens collected in Demonstration 1 and practice identifying the collections to order, family, common name, and/or genus and species (where possible), as well as feeding guild. Using printed visual keys and on-line resources, help students identify the insects they've collected as either "pest" or "beneficial." After identifying the insects and crop damage, students should research and discuss the thresholds for each of the pests observed, and the National Organic Program-accepted control options available had the thresholds been exceeded.

PREPARATION AND MATERIALS

- Insects collected by students in Demonstration 1 (or by instructor, if Demonstration 1 is not used)
- Examples of insect-damaged plants
- Notebook for documenting lab observations
- Hand lenses and/or dissecting scopes with external light source
- Lab with multiple computer terminals with internet access (see Resources for identification websites)
- Insect identification books (see Flint 1998 in Resources)
- White board for drawing insects

PREPARATION TIME

1 hour (or longer, if insects are not already collected)

DEMONSTRATION

1 hour

DEMONSTRATION OUTLINE

A. Provide students with key taxonomic features to distinguish previously-collected insects of various orders, families and feeding guilds

1. Grasshoppers and crickets (Orthoptera)
 - a) Key characteristics: Enlarged hind femur, well developed cerci, chewing mouthparts
2. Planthoppers, leafhoppers, aphids, scale, and mealybugs (Homoptera)
 - a) Key characteristics: Piercing-sucking mouthparts, four wings of uniform texture, two to three ocelli may be present
3. True “bugs” (Hemiptera)
 - a) Key characteristics: Apparent piercing-sucking mouth (beak or rostrum) extends down much of ventral side, forewings only half membranous, scutellum apparent in most species
4. Flies (Diptera)
 - a) Key characteristics: only one pair of true wings; hind wings modified into halteres, frequently sucking or sponging mouthparts, antennae are often short and located between eyes, sometimes with arista
5. Butterflies and moths (Lepidoptera)
 - a) Key characteristics: Four enlarged wings with scales, long and curled proboscis, antennae often clubbed or plumose
6. Beetles (Coleoptera)
 - a) Key characteristics: Front wings hardened with elytra, well developed mandibles, antennae sometimes strongly clubbed
7. Bees and wasps (Hymenoptera)
 - a) Key characteristics: Four true wings, antennae usually elongate, ovipositor well developed, attachment point between thorax and abdomen (propodeum) sometimes constricted
8. Arachnids
 - a) Key characteristics: Two body segments, eight legs
 - i. Spiders (Araneae)
 - ii. Mites (Acari)

B. Provide Students with Crops Damaged by Pest Insects

1. Potential examples include “cat-faced” strawberries, broccoli floret with cabbage aphids, corn with the corn ear worm, codling moth larvae in apples, cole crops with flea beetle foliar damage, etc.

C. Students Conduct Identification Exercise

1. Instructor demonstrates use of key features (outline above), along with on-line and printed resources to identify samples of arthropods and plant damage (see Resources section)
2. Working in small groups, students practice identifying the collections to Order, genus, and species (when possible), common name, feeding guild, “pest” or “beneficial” designation
3. Small student groups share/report identification to peers and instructor
4. Instructor confirms identification

5. Students research and discuss the thresholds for each of the pests observed on the crops (whether or not a threshold has been exceeded should include a discussion of the presence and abundance of natural enemies)
6. Students research and present NOP-accepted physical, biological, and chemical control options available had the thresholds been exceeded
7. Instructor shares anecdotal information on control options

Assessment Questions

- 1) Describe five practices used in sustainable horticulture and agriculture, and how they serve to prevent the growth of pest populations beyond economic thresholds.
- 2) What are the essential components of a sound pest management program for a certified organic farm or garden?
- 3) Describe the protocol you would use in monitoring your fields for insect/arthropod pests and natural enemies.
- 4) List five arthropod pests and the crops they affect in your region. What are the National Organic Program-certified physical, chemical, biological, and cultural control options available for these pests?
- 5) How might non-crop vegetation help manage insect pests? How might it be detrimental? Name five different non-crop plants that farmers use in your area to enhance biological control. How do each of these plants serve to enhance biological control?

Assessment Questions Key

1) Describe five practices used in sustainable horticulture and agriculture and how they serve to prevent the growth of pest populations beyond economic thresholds.

- *Crop rotation: Crop rotation interrupts pest/ host cycle by changing the crop grown on a given piece of ground.*
- *Cover cropping: Cover cropping is a form of crop rotation; some cover crop species attract natural enemies of agricultural pests. Many cover crops also have allelopathic qualities that suppress pest populations. It's also important to avoid choosing inappropriate crops that would attract pests.*
- *Polyculture cropping patterns: Provide greater plant diversity within the agricultural ecosystem, thereby maintaining the carrying capacity for pests at a lower level than in a monoculture. Also increase the possibility of beneficial insect habitat.*
- *Sound irrigation and tillage practices to retain essential plant nutrients, avoid soil erosion and compaction, and maintain desirable soil physical properties.*
- *Maintain native plant associations in and around the farm and farmscaping: Serve to attract natural enemies of agricultural pests or repel pests*
- *The use of resistant crop varieties*

Sound soil fertility management including the following components:

- *Soil organic matter management (maintaining soil organic matter levels ideally between 3–5%) will help maintain soil biological activity and diversity, optimizing soil physical properties and some naturally occurring pest suppression.*
- *Supplying optimal levels of essential plant nutrients without overfertilizing. Through soil analysis and accurate nutrient budgeting, combined with efficient soil amending and supplemental fertilizing, pest problems associated with both overfertilization and plant nutrient deficiencies should be reduced.*

2) What are the essential components of a sound pest management program for a certified organic farm or garden?

- *The use of preventive agricultural and horticultural practices (above)*
- *Systematic monitoring and documentation of pest populations, crop damage, and the presence and abundance of beneficial insects*
- *Accurate identification of arthropods present in the farm and garden and an understanding of the ecology of agronomically important arthropods, including natural enemies of agricultural pests*
- *Research and establishment of control action thresholds for each crop*
- *Active (non-preventive) control methods: Physical, cultural, and/or biological control options.*

3) Describe the protocol you would use in monitoring your fields for insect/arthropod pests and natural enemies.

- *Survey crops systematically for visual inspection/observation 1x/week, and 2x/week during peak growing season*

For vegetable crops:

- *Walk furrows and check both sides of leaves on every few plants. Collect samples and identify.*
- *Remove wilted plants and examine root system for indications of soil borne insects or pathogens. Collect and identify samples.*

For root crops:

- *Check the soil before you plant from the soil level to 4 inches down by running your fingers through the soil looking for small insects. Collect and identify samples.*

For orchards:

- *Check trunk for injury*
- *Check fruit for scars or points of entry. Collect samples and identify.*
- *Check interior of grounded fruit for pest presence. Collect and identify.*

- *Always examine both sides of leaves on each side of the tree.*

Assess and record the following:

- *Date, time, crop, and weather conditions*
- *Is proper cultural care being delivered?*
- *Number of pests observed*
- *Amount and type of damage*
- *Presence and numbers of beneficials/natural enemies*
- *Evidence of parasitism or predation*
- *Stage of crop development*
- *Management actions taken*

- 4) List five arthropod pests and the crops they affect in your region. What are the National Organic Program-certified physical, chemical, biological, and cultural control options available for these pests? (answers will vary)
- 5) How might non-crop vegetation help manage insect pests? How might it be detrimental? Name five different non-crop plants that farmers use in your area to enhance biological control. How do each of these plants serve to enhance biological control? (answers will vary)

Resources

PRINT RESOURCES

BOOKS

Altieri, Miguel, Clara I. Nicholls, and Marlene A. Fritz. 2005. *Manage Insects on Your Farm: A Guide to Ecological Strategies*. Handbook Series Book 7. Beltsville, MD: Sustainable Agriculture Networks.

Offers information on how to set up your farm to mitigate the effects of certain insect pests. California orientation.

Caldwell, Brian, et al. 2013. *Resource Guide for Organic Insect and Disease Management, Second Edition*. New York State Agricultural Experiment Station. Ithaca, NY: Cornell University. web.pppmb.cals.cornell.edu/resourceguide/

Provides a useful and scientifically accurate reference for organic farmers and agricultural professionals who are searching for information on best practices, available materials, and perhaps most importantly, the efficacy of materials that are allowed for use in organic systems. Available for free download.

Flint, Mary Louise. 1998. *Pests of the Garden and Small Farm: A Grower's Guide to Using Less Pesticide, Second Edition*. Publication 3332. Oakland, CA: University of California Division of Agriculture and Natural Resources.

Covers insects, mites, plant diseases, nematodes, and weeds of fruit and nut trees and vegetables. Individual sections describe the biology, identification, and control of 95 common pests; includes symptom-identification tables organized by crop. Recommended methods rely primarily on organically acceptable alternatives.

Flint, M. L., and S. H. Dreistadt. 1999. *Natural Enemies Handbook: The Illustrated Guide to Biological Pest Control*. Publication 3386. Oakland, CA: University of California Division of Agriculture and Natural Resources.

A valuable resource for biological control of pests and pathogens.

Gurr, G., and S. D. Wratten, eds. 2002. *Biological Control: Measures of Success*. Springer Science + Business Media B.V.

Includes a review and discussion of how and why various attempts at biological control were either successful or fruitless; discusses considerations for how the prospects of future biological control projects can be improved upon.

Gurr, G., S. D. Wratten, and M. Altieri, eds. 2004. *Ecological Engineering for Pest Management: Advances in Habitat Manipulation for Arthropods*. Csiro Publishing.

Discusses international farmscaping efforts to reduce crop loss; new approaches are included, such as molecular analyses, cutting-edge marking techniques and remote sensing; possible interactions with genetic engineering are also discussed.

Pickett, C. H., and R. Bugg, eds. 1998. *Enhancing Biological Control: Habitat Management to Promote Natural Enemies of Agricultural Pests*. Berkeley: University of California Press.

A comprehensive investigation of conservation biological control through habitat manipulation; provides case studies from across the globe, including vineyards, orchards and hedgerows.

PERIODICALS

Bio-Integral Resource Center:

Common Sense Pest Control Quarterly

www.birc.org/

Features least-toxic solutions to pest problems of the home and garden.

Bio-Integral Resource Center:

The IPM Practitioner

www.birc.org/

Focuses on management alternatives for pests such as insects, mites, ticks, vertebrates, weeds, and plant pathogens. Each issue contains an in-depth article ("Updates") on a research topic in integrated pest management (IPM).

Entomological Society of America:

Journal of Integrated Pest Management
esa.publisher.ingentaconnect.com/content/esa/jipm/

Free online peer-reviewed journal covering topics in IPM.

University of California, Division of Agriculture and Natural Resources:

California Agriculture
californiaagriculture.ucanr.org/

Free online peer-reviewed journal covering contemporary agricultural issues in California.

WEB-BASED RESOURCES

Agriculture Research Service Plant Sciences Institute

www.ars.usda.gov/

Includes links to information on insect biocontrol, systematic entomology, insect behavior, and other research efforts within the USDA.

Association of Natural Biological Control Producers

www.anbp.org/

Resources, meetings, and other information on biocontrol

ATTRA: Farmscaping to Enhance Biological Control

www.attra.org/attra-pub/farmscape.html

Excellent “how-to” information on increasing and managing biodiversity on a farm to favor beneficial organisms. Can be downloaded in PDF format.

Bioquip

www.bioquip.com

Books, equipment, and supplies for entomology and related sciences.

Brooklyn Botanical Garden Natural Pest Control

www.bbg.org/gar2/pestalerts/

Lists “alerts” on insects, diseases, and invasive plants.

Brooklyn Botanical Garden Natural Pest Control

www.bbg.org/gar2/pestalerts/

Lists “alerts” on insects, diseases, and invasive plants.

California Pest Management Guidelines

www.ipm.ucdavis.edu/PMG/crops-agriculture.html

Database supplies the University of California’s official guidelines for pest monitoring techniques, pesticides, and non-pesticide alternatives for managing insect, mite, nematode, weed, and disease pests in agricultural crops, floriculture and ornamental nurseries, commercial turf, and in homes and landscapes.

Center for Invasive Species Research

cirs.ucr.edu/

Provides a forward-looking approach to managing invasions in California by exotic pests and diseases. The CISR is heavily involved with classical biological control research.

Cornell University Biological Control: A Guide to Natural Enemies in North America

www.biocontrol.entomology.cornell.edu/

Provides photographs and descriptions of biological control (or biocontrol) agents of insect, disease, and weed pests in North America. It is also a tutorial on the concept and practice of biological control and integrated pest management (IPM).

International Organisation for Biological Control

www.iobc-global.org/

Promotes environmentally safe methods of pest and disease control.

New York State/Cornell IPM Program

www.nysipm.cornell.edu

Valuable resource covering many fruit and vegetable crops, including identification information, cultural practices and inputs to manage pests and diseases.

Organic Trade Association

ota.com/

Provides organic statistics and serves as a clearinghouse for pesticide studies pertaining to public health and the environment.

Peaceful Valley Farm Supply

www.groworganic.com

Contains listings of many Organic Materials Review Institute-approved pest management resources for monitoring and control.

Pennsylvania State University IPM Links

paipm.cas.psu.edu/websites/Links.html

Links to a wide variety of sites on IPM, biological control, insects, invasive species, etc.

Pesticide Action Network of North America (PANNA)

www.panna.org

Advances pesticide alternatives worldwide, supports research on impacts of pesticides, and provides technical support to partners interested in decreasing or eliminating pesticide use.

Rincon Vitova Insectaries

www.rinconvitova.com/

California-based commercial insectary for augmentative biological control services.

University of California Division of Agriculture and Natural Resources (UC DANR)

anrcatalog.ucdavis.edu/

Contains an online catalogue of UC DANR crop-specific IPM publications and links to IPM websites.

UC IPM Publications and other educational materials

www.ipm.ucdavis.edu/IPMPROJECT/pubs.html

A guide to publications, newsletters, slides, videos, and other educational material produced by the University of California's IPM program. Some materials is available online in PDF format.

UC Sustainable Agriculture Research and Education Program (UC SAREP)

www.sarep.ucdavis.edu

Includes information on biologically integrated farming systems and other alternative pest management programs.

USDA Forest Service and the Bugwood Network

www.insectimages.org

More than 5,400 high-quality insect and insect damage photographs available in digital format. Entries are classified by subject, common name, scientific name, life stage, and host. From the easily navigated website one can quickly click to the desired target. Available for downloading and use for educational applications with no royalties or fees required, as long as appropriate credit is given to the source.

Appendix 1: Arthropod Pest Management Field Observations Records Sheet

	Crop:	Crop:	Crop:	Crop:
Date, time				
Stage of crop development				
Is proper cultural care being delivered? Describe				
Genus, species, common name of pests observed				
Number of pests observed				
Amount, type of crop damage observed				
Name, number of beneficial insects				
Evidence of parasitism or predation				
Description of control action threshold for pest				
Management actions taken and date				

Managing Plant Pathogens

Introduction	373
Lecture 1: Managing Plant Pathogens	375
Demonstration 1: Practical Plant Disease Diagnosis, Biology and Management	
Instructor's Demonstration Outline	381
Students' Step-by-Step Instructions	383
Assessment Questions and Key	385
Resources	387
Supplement 1: The Importance of Farmer-to-Farmer Social Networks	389

Introduction: Managing Plant Pathogens

UNIT OVERVIEW

Prevention and early diagnosis are critical to limiting damage by plant pathogens. This unit introduces students to the fundamental concepts and basic skills needed to identify and manage plant pathogens in certified organic production systems. Topics include the economic importance of plant pathogen management and the basic biology (especially life cycles) of bacteria, fungi, viruses, nematodes, phytoplasmas, and parasitic higher plants that are common plant pathogens and vectors in agricultural systems. Abiotic diseases such as nutrient deficiencies and air pollution are presented, along with the interactions among environment, pathogen, and crop plant. Management techniques for each pathogen and vector are also discussed.

MODES OF INSTRUCTION

- > LECTURE (1 LECTURE, 3.0 HOURS)
The class lecture covers the basics of plant pathology: History and causes of disease, biology of causal organisms, disease diagnosis, ecological management, climatic factors. Note: as you begin the lecture, pass around 5 samples of ubiquitous plant diseases, including (at least 1) fungal, oomycete, bacterial, and viral on both herbaceous and woody plants. Choose plants and diseases the students are likely to have seen; powdery mildew and Botrytis are particularly helpful. After the discussion of the Evolutionary Ecology of Plant Diseases (point D in the lecture) is a good place to take a break.
- > DEMONSTRATION 1: DISEASE IDENTIFICATION (1.5 HOURS)
During the disease identification demonstration, students will collect and diagnose diseases and disease-like samples they gather. Management techniques for each disease will be discussed.
- > ASSESSMENT QUESTIONS: (0.5–1 HOUR)
Assessment questions reinforce key unit concepts and skills.
- > POWERPOINT
See casfs.ucsc.edu/about/publications, and click on Teaching Organic Farming & Gardening.

LEARNING OBJECTIVES

CONCEPTS

- The economic importance of plant pathogen management
- Basic biology (especially life cycles) of bacteria, fungi, viruses, nematodes, phytoplasmas, parasitic higher plants
- Abiotic diseases: Nutrient deficiencies and air pollution
- The disease triangle: Interactions among environment, pathogen, and plant
- Disease management from an ecological perspective

SKILLS

- How to collect samples of diseased plants and use diagnostic resources

Lecture 1: Managing Plant Pathogens

Pre-Assessment Questions

1. What is plant disease?
2. What are the steps involved in diagnosing plant diseases?
3. Why are plant diseases rare in natural systems, yet common in agriculture?
4. What are the main causal organisms for plant diseases?
5. What is the disease triangle, and how do we use it in ecological disease management?

A. Description, Economic Importance of Plant Disease

1. What is plant disease?

A disruption in normal physiology—usually with some kind of negative effect on survival or fitness of the individual. For most plant pathologists, this includes infectious agents, nutrition, and air pollution. They also include nematodes as causing disease, but not insects, mites, or genetic abnormalities, unless infectious agents cause them. In practice, most plant pathologists work with infectious agents: The three most important, by far, are fungi, bacteria and viruses.

2. Economic importance of plant disease

Diseases are important to humans because they cause damage to plants and plant products, commonly with an associated economic effect, either positive or negative. Negative economic effects include crop failure, incremental loss from lower quality or failure to meet market standards, elimination of crop options because of disease propagule buildup, or the costs of control methods. A positive effect is the creation of new endeavors to manage diseases.

B. Disease Diagnosis

Accurately diagnosing the cause of a disease is key to management. Unfortunately, professional help is frequently necessary. Fortunately, anyone can learn to collect a good sample (see Demonstration 1, Practical Plant Disease Diagnosis, Biology and Management).

1. Symptoms should exist on several individual plants and not have an obvious non-pathogen cause
2. Observe the pattern of symptoms or signs in the field, and don't forget to look at the roots if the symptoms include wilting. A symptom is an observation of the host response to infection by the pathogen. A sign is a visible structure of the pathogen itself, and is much more diagnostic.
3. Whenever possible, collect a sample that includes the border between healthy and diseased tissue (this is likely where the pathogen is most active, making the observation of signs, and pathogen isolation in the lab, more probable)
4. Collect a range of symptoms from light to heavy. Bring as much of each diseased plant as possible, including roots; bring samples from more than one plant and note the distribution of symptoms in the field.
5. Resources to help diagnose plant diseases include Cooperative Extension services, other professionals, and pictorial disease guides (see Resources section for print and web-based diagnostic resources). It is easy to misdiagnose a disease. Be cautious diagnosing and treating diseases on your own until you have experience.

C. Evolutionary Ecology of Plant Disease

Plant disease has an essential role in plant evolution and ecosystems. Understanding this role helps us design more resilient farm systems.

1. Viruses are special

There is a debate as to whether viruses are living organisms or not. In many ways they straddle the line between biotic and abiotic. Viruses replicate and evolve at an extraordinary rate but they cannot make their own proteins, have no nutritional requirements, and most are composed of only nucleic acids and protein. How viruses evolved is unclear but many think that viruses are remnants of the earliest forms of "life." Viruses may lead to evolutionary changes in their hosts through transfer of genetic materials. Viruses hop in and out of different hosts and may occasionally bring along bits of host DNA with them and transfer it to a new host; they are the original genetic engineers.

2. Probable evolutionary history of non-virus pathogens

A range of nutritional strategies exist for plant pathogens. The majority of fungi and bacteria exist as saprophytes (decomposers) indicating that this is likely the ancestral nutritional strategy. Early life forms died and saprophytes evolved to "clean up" and recycle their bodies. Gradually, saprophytes gained the ability to "feed" on live plants and became pathogens. Some evolved further, losing all saprophytic ability and became obligate pathogens (must have a living host). Fossil records of plant symbionts indicate that some pathogens, such as oomycetes, evolved from photosynthetic algae.

3. Obligate (must have a host) and non-obligate pathogens

Non-virus plant pathogens range on a scale from completely obligate (eg powdery mildews) to almost completely non-obligate (e.g., Botrytis rots). Both types of pathogens are essential for ecosystem diversity and overall health.

- a) Obligate pathogens have evolved such that they can only live on the plant species within their narrow host range and have no saprophytic ability (i.e., cannot live on dead tissue). They cannot exist in an active form without a live host. An obligate pathogen that is extremely virulent (able to attack and kill all individuals of its host range) would result in extinction of its host, followed quickly by extinction of the pathogen itself. Thus, survival for both host and obligate pathogen depends on a dynamic, genetic relationship between host resistance and pathogen virulence, in which neither organism can gain complete domination over the other. Plants and pathogens have genetic flexibility such that sexual reproduction produces diverse individuals containing a variety of resistance and virulence genes (gene-for-gene interactions). In natural (undisturbed) ecosystems, obligate pathogens are common but do not inflict much damage on their hosts, except to the few plants that arise without resistance.
- b) Non-obligate pathogens don't have or need the same close genetic relationship with their plant hosts, because they can live on organic matter and/or a wide range of host plants. In these interactions host genetics are less important than environmental factors (e.g., humidity) in determining plant susceptibility. In undisturbed ecosystems, micro-environments vary widely, preventing non-obligate pathogens from doing much damage, but also helping to ensure no one plant species or genotype excludes all others. If a particular plant genotype dominates a natural system, plant disease will act as a "reset button" to restore diversity. Even the mighty redwoods will not dominate forever!

4. Why agriculture increases the incidence of plant disease

Agriculture, and in particular the use of hybrid crop varieties and monocultures, circumvents natural checks and balances. For high yields, plants are grown close together and given abundant water: Ideal environments for obligate and non-obligate plant pathogens. Continuous, large quantities of genetically similar hosts skew natural selection

to accelerate the appearance of highly virulent obligate pathogens. The associated high risk of widespread catastrophic disease can only be tolerated with effective pesticides and/or a strong plant breeding program. In contrast, ecological plant pathology attempts to decelerate the evolution and success of virulent pathogens by reducing the pathogens' access to these hosts, and improving the micro-environment. It isn't easy to control agricultural plant diseases ecologically because agriculture, by definition, is an unnatural environment, where we artificially favor specific plant genes and high plant density. However, we can use our knowledge of ecology and evolution to design the whole growing system to slow down, reduce, or avoid disease on plants. "Pesticide-based" agriculture has often ignored ecological principles in designing cropping systems.

5. Nutritional strategies of pathogens

Bacteria and fungi do not ingest their host, but use absorptive nutrition (enzymatic degradation outside the pathogen). Nematodes use alimentary nutrition (enzymatic- and bacterial-mediated degradation inside the pathogen). Viruses are obligate intracellular molecular parasites: They do not acquire nutrition from their host, rather they use the host's molecular machinery to make new viruses.

D. How Pathogens Cause Disease

1. Enzymatic degradation

Pathogens secrete enzymes, which catalyze the breakdown of host tissues, similar to the digestion of food in mammals. Symptom: Rotting.

2. Toxins

Pathogens often benefit by producing toxins, which kill the tissue in advance of enzymatic degradation. In many pathogens, particularly non-obligate pathogens, toxins cause the majority of damage to the host. Symptom: Yellowing. Some pathogen products damage or plug up the plant's plumbing (xylem or phloem). Symptom: Wilting and stunting.

3. Growth regulators

Pathogens often find it advantageous to produce growth regulators (or cause the host to produce them). The most common are those that cause translocation of nutrients to host cells and/or cause host cells to enlarge or divide in the vicinity of the pathogen, thus providing an increase in food for the pathogen. This allows the host to go on living while providing ample food for the pathogen. Symptoms: Tumors and stunting.

4. Genetic manipulation

All viruses, plus a few bacteria, are able to force the plant to produce pathogen proteins (gene products) from pathogen genetic material. This severely decreases the amount of plant protein available for normal cell function, resulting in dysfunctional cells. Symptoms: Tumors, stunting, twisting, yellowing, mosaic patterns.

E. Causal Organisms

1. Bacteria

Bacteria are single celled, have no nucleus, and one chromosome. They have a limited overall size, but unlimited reproduction by fission (no chromosomal segregation). This allows bacteria to reproduce faster than fungi and may result in quick epidemics. They use absorptive nutrition, and most in nature are saprophytic. Pathogens cause blights (rapid, toxic killing of plant tissue), rots (mushy breakdown), wilts (plugging of vasculature), and galls (growth regulator-mediated enlarged areas on plants). Bacteria are very sensitive to the environment. Individual actively replicating bacteria don't have much protection from sunlight and drying; however, in nature bacteria often exist as a biofilm, which consists of a mixture of different bacteria inside a matrix of protective slimy material (dental plaque is a biofilm of mouth bacteria). When not actively replicating or within biofilms, plant pathogenic bacteria have found ways to survive unfavorable conditions such as living

inside seed coats. They spread by wind, water, seeds, people and insect vectors. Examples: Fire blight on pear, crown gall on many woody plants, citrus greening disease of citrus (huanglongbing), Pierce's disease of grape, soft rot on many herbaceous plants.

2. Fungi

Fungi are connected cells with nuclei, multiple chromosomes, mitochondria, and chitin for strength. Their overall size is unlimited, but without a vascular system they don't have good connections/ "communication" among segments and easily fragment into multiple bodies. Most are able to form differentiated structures used in reproduction and dispersal, e.g., mushrooms, spores. Like bacteria, most are saprophytic. Plants infected with fungi exhibit many symptoms, including rot, blight, leaf spots, and wilts. Fungi are fairly sensitive to light and dry conditions when growing, but can make very resistant structures to survive. They spread by wind, water, seed, and vectors. Examples: Apple scab, powdery mildews, peach leaf curl.

3. Oomycetes

Oomycetes are like fungi in many ways, but have a different evolutionary history, perhaps arising from photosynthetic algae that lost the ability to photosynthesize. They produce zoospores (mobile spores) and oospores (survival spores). Most are water or soil inhabitants, and favored by free water or a film of water in which zoospores can swim. Oomycetes are spread by wind, water, seed, and vectors. Examples: Downy mildew, Pythium (damping-off), Phytophthora root rots.

4. Viruses

Viruses are pieces of nucleic acid (RNA or DNA) inside a protective coating usually made only of protein. Viroids are even smaller than viruses and are just small pieces of naked RNA. They are always a parasite, although not necessarily a pathogen. The nucleic acid in a virus only codes for a few proteins that the virus needs to replicate and move through the plant. Viruses are molecular parasites meaning that they take over the molecular machinery of the host cell and cause it to produce virus proteins instead of host proteins. Symptoms mimic genetic abnormalities and nutritional deficiencies and include mosaics, yellows, distortions, and death. Viruses spread by mechanical means, seed, or vectors, which is an important consideration when choosing a control method. Most plant viruses are able to cause disease on several different hosts and some viruses can infect over 1,000 different species of plant. Examples: Tobacco mosaic virus, Cucumber mosaic virus, Tomato spotted wilt virus, Beet curly top virus.

5. Nematodes

Nematodes are microscopic worms; the presence of a stylet (a needle-like mouthpart that is stabbed into the host) differentiates plant parasitic nematodes from saprophytes. They occur as ecto-nematodes (all but the head is outside the plant) and endo-nematodes (the entire nematode is inside the plant), and can be sedentary or migratory. Injection of the nematode's saliva upsets plant metabolism, causing an excess or shortage of nutrients or hormones. Symptoms include tumors and death of affected parts. Nematodes spread slowly unless carried by water or humans and occur most often in sandier soils and warmer climates. Examples: Rootknot nematode on many plants, beet cyst nematode on vegetables.

6. Phytoplasmas

"Bacteria without a cell wall," phytoplasmas are fastidious (very fussy eaters) obligate pathogens that are only able to survive inside the plant vascular system (xylem and phloem). Because phytoplasmas cannot survive outside of the plant vascular system they are only spread to new plants through grafting and insect vectors. Examples: Pear decline, aster yellows.

7. Parasitic higher plants

Parasitic vascular plants rely on a host for water and minerals (green-colored leaves) and sometimes carbohydrates as well (non-green-colored leaves). Deleterious effects are usually from hormonal upset of the host rather than nutrient or water loss. These parasites occur primarily in forestry, perennials, and poorly managed annual crops. Examples: Mistletoe on trees, dodder on vegetables.

8. Abiotic

Nutrient toxicities (too much) and deficiencies (too little) in a plant occur as a result of nutrient toxicities or deficiencies in the rock from which the soil formed, or from poor management. Examples: Iron, nitrogen, potassium, zinc, copper, boron toxicities or deficiencies. Air pollution: Lead, NO_2 , CO, HF, Ozone, SO_2 .

F. Ecological Disease Management

1. Disease triangle (Host / Environmental Growing Conditions / Pathogen)

In general, disease results from a susceptible host, a virulent pathogen, and a favorable environment. Together, these three factors make up the disease triangle. All three must occur at the same time for disease to occur. Pesticide-based agriculture concentrates on reducing the disease after it is first seen, or on a spray schedule using a calendar or forecaster that examines environmental conditions. Ecological disease management concentrates on avoiding conditions that predispose plants to disease. Note that this is quite unlike arthropod management, where a range of natural enemies can be encouraged or deployed. Organic farmers often make the mistake of assuming that the methods for disease and arthropod management are the same.

Theoretically, approaches that avoid disease make more sense than those that try to fix things afterwards. Chemical fixes may have unintended effects, including plant toxicity and removal of natural enemies that were controlling other pest problems. In general, strongly growing, healthy plants are most able to resist disease, although exceptions occur. Plant susceptibility to a particular disease usually changes depending on the amount and type of physiological stress. To some extent, growers can manipulate the Disease Triangle (above)—the host, the pathogen, or environmental conditions—as outlined below.

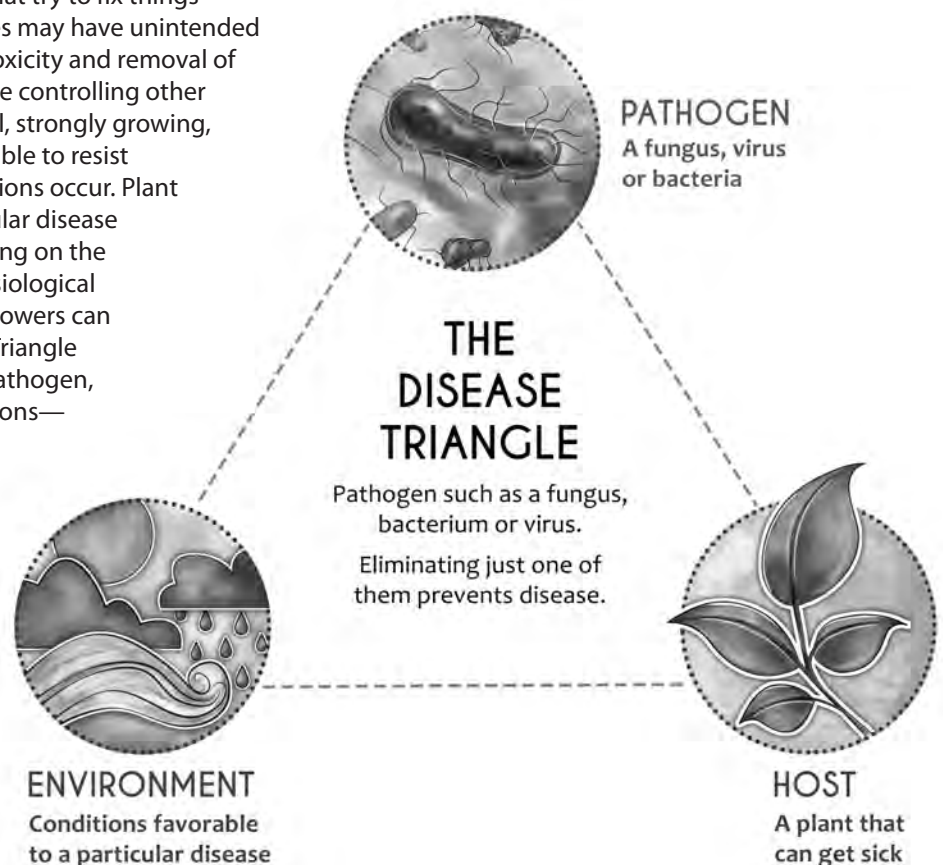

Illustration by José Miguel Mayo

2. Environmental manipulations

The grower usually has most control over the cropping environment; examples include increasing plant spacing (to reduce humidity and decrease infection), regulating the amount of irrigation and drainage, choosing where the crop is grown (climate, soil, nutrition, landscape diversity, soil biodiversity), etc.

3. Host manipulation

We often have less control of the host, since we have already chosen it in the crops we are growing. We can look for resistant cultivars, use pathogen-free planting materials (through quarantine or eradication techniques such as hot-water seed treatment), and practice crop rotation (both temporal and spatial, such as intercropping).

4. Pathogen manipulations

We try to keep the pathogen out of the field, or get rid of it when it is seen (either manually by removing affected host tissue, or by using chemical controls). Unlike industrial agriculture, few highly effective chemical controls are available to organic growers besides sulfur and copper. Commercial use of non-pathogenic microbes to compete with, kill, eat, and induce resistance to pathogens is far behind arthropod systems. Ecological agriculture, with its goal of both high numbers and diversity of microbes in soil and on leaves, may increase its reliance on non-pathogens for disease control in the future.

5. Climate and weather patterns that encourage the rate of growth, development, and distribution of certain plant pathogens

In general, most plant pathogens like wet, warm weather with an abundance of free moisture on plant surfaces. However, some pathogens, such as powdery mildew, will be inhibited by rainfall, and overhead irrigation is sometimes used to control this disease. Weather that is too hot or too cold for the plant to grow properly can make the host susceptible to disease. Some pathogens, such as many of the anthracnose diseases, need rain to spread their spores; others need wind (such as the powdery and downy mildews), and some need both wind and rain (some bacterial diseases). A critical pest management step is to insure the compatibility of one's crop and crop varieties with the regional growing climate where production will take place.

Demonstration 1: Practical Plant Disease Diagnosis, Biology & Management

for the instructor

OVERVIEW

Through this hands-on field exercise and discussion, students will learn how to collect representative samples of diseased plant tissues from their own farm and garden, observe the instructor's methods for diagnosis, and learn management techniques for each pathogen and vector.

PREPARATION AND MATERIALS

1. If possible, students should have received the lecture portion of this unit covering disease diagnosis. If not, present this material.
2. Divide the class into groups of four or fewer students and give them a half hour to collect suitable samples of plants that they think may have disease and that they are most interested in.
3. Give the students a small break and sort the samples setting aside the ones that will best illustrate important plant disease concepts.

PREPARATION TIME

5 minutes

DEMONSTRATION TIME

1.5 hours

DEMONSTRATION OUTLINE

Proceed through as many samples as you have time for. Encourage student questions.

A. Diagnosis

1. Host
2. Type and extent of symptoms
3. How relatively useful the symptoms are for diagnosis
4. The importance of professional help, and lab analysis in accurate diagnosis
5. Discuss the danger of guessing

B. Provide illustrations of Pathogens or Characteristic Symptoms

C. Give a Synopsis of the Disease and Management Practices

1. The relative importance of actively managing the pathogen (i.e., potential agricultural and economic consequences of unchecked growth)
2. Biology: Life cycle and timing for intervention
3. Review of ecological disease management practices accepted under certified organic farming standards, using the disease triangle
 - a) Environmental manipulations
 - b) Host manipulations
 - c) Pathogen manipulations

Demonstration 1: Practical Plant Disease Diagnosis, Biology & Management

step-by-step instructions for the students

OVERVIEW

The key to successful disease management is accurate diagnosis, an understanding of the biology of the causal agent, and use of the disease triangle to design a management system. These step-by-step instructions will assist you in collecting suitable samples of affected plants and allow the instructor to illustrate these concepts.

PROCEDURE

- Collect suitable samples from plants that you think have disease and that you find interesting.
- Symptoms should exist on several individual plants and not have an obvious non-pathogen cause.
 - Observe the pattern of symptoms or signs in the field (they can provide information about how the disease spreads) and don't forget to look at the roots whenever possible.
 - Whenever possible, collect a sample that includes the border between healthy and diseased tissue.
 - Collect a range of symptoms from light to heavy. Bring as much of the plant as possible, including roots. Bring samples from more than one plant.

Assessment Questions Key

1) List five different plant diseases, including the pathogen, plant host, and how each one interferes with normal plant physiology.

- *Bacteria*
- *Fungi*
- *Viruses*
- *Nematodes*
- *Mycoplasma-like organisms*
- *Parasitic higher plants*
- *Nutrient deficiencies*
- *Air pollutants*

2) What are three environmental conditions that often encourage the growth, development, and distribution of bacterial and fungal blights?

- *High relative humidity*
- *Warm (temperatures 55°F or higher)*
- *Free moisture on plant surfaces*

3) Describe three specific environmental manipulations that farmers/gardeners may use to manage or prevent plant pathogens ecologically.

- *Increase crop spacing (to reduce humidity)*
- *Regulate amount or timing of irrigation (to reduce humidity, moisture on foliage, or soil moisture levels)*
- *Regulate drainage (to influence soil moisture levels)*
- *Changes to crop and soil type*
- *Changes to soil nutrient levels*
- *Changes to crop location relative to climate and microclimate*

4) What are the four techniques that should always be included when taking a suitable sample for disease diagnosis?

- *Symptoms existing on several individual plants*

- *Make observations of patterns of symptoms*
- *Make observations of both foliage and roots*
- *Collect samples from the border between healthy and potentially diseased plant tissues*
- *Collect a range of samples exhibiting symptoms including heavily and lightly affected*

5) Describe three specific plant host manipulations that farmers/gardeners may use to manage or prevent plant pathogens ecologically.

- *Select disease-resistant cultivars*
- *Use only certified disease-free plant materials*
- *Crop rotations in both space and time*

Resources

PRINT RESOURCES

BOOKS

Agrios, George N. 2005. *Plant Pathology, Fifth Edition*. Amsterdam: Elsevier Academic.

A textbook of plant pathology from general to specific topics.

Compendium of Diseases. St. Paul, MN: APS Press.

A series of publications covering diseases of many common crops, published by the American Phytopathological Society's APS Press.

Flint, Mary Louise. 1998. *Pests of the Garden and Small Farm: A Grower's Guide to Using Less Pesticide, Second Edition*. Publications 3332. Oakland, CA: University of California Division of Agriculture and Natural Resources.

Covers insects, mites, plant diseases, nematodes, and weeds of fruit and nut trees and vegetables. Individual sections describe the biology, identification, and control of common pests and pathogens; includes symptom-identification tables organized by crop. Recommended methods rely primarily on organically acceptable alternatives.

Flint, Mary Louise. 2012. *IPM in Practice: Principles and Methods of Integrated Pest Management, Second Edition*. Publications 3418. Oakland, CA: University of California Division of Agriculture and Natural Resources.

Great introduction to understanding and implementing integrated pest management of plant pathogens, weeds, and insects.

Flint, Mary Louise, and Steve Dreistadt. 1998. *Natural Enemies Handbook: The Illustrated Guide to Biological Pest Control*. Publication 3386. Oakland, CA: University of California Division of Agriculture and Natural Resources.

How-to book describes ways to combine cultural, physical, and chemical methods with biological control; to minimize pesticide impacts on natural enemies; release natural enemies and enhance their activity; and identify and use natural enemies to control pests.

Koike, Steve. 2006. *Vegetable Diseases: a Color Handbook*. Manson Publishing Ltd.: London.

Extensive, excellent photos of many common vegetable diseases.

Koike, Steve, Mark Gaskell, Calvin Fouche, Richard Smith, and Jeff Mitchell. 2000. *Plant Disease Management for Organic Crops*. Publication 7252. Oakland, CA: University of California Division of Agriculture and Natural Resources.

Describes various techniques for managing diseases in organic crops, including use of resistant plants, site selection, pest exclusion, and compost use.

Pscheidt, Jay W., and Cynthia M. Ocamb (eds.). 2015. *Pacific Northwest Plant Disease Management Handbook*. Corvallis, OR: Oregon State University. pnwhandbooks.org/plantdisease/node/1788/print

A ready reference guide to the control and management tactics for the more important plant diseases in the Pacific Northwest.

Schumann, Gail L., and Cleora J. D'Arcy. 2012. *Hungry Planet: Stories of Plant Diseases*. St. Paul, MN: The American Phytopathological Society.

Describes the impact of several different plant diseases and illustrates basic biological and plant pathology concepts in an easy-to-understand way.

University of California IPM Program. *Integrated Pest Management Manual Series*. Oakland, CA: University of California Division of Agriculture and Natural Resources.

Comprehensive IPM manuals for growers and pest control advisors offer detailed information on numerous agricultural crops, landscape trees and shrubs, and home gardens.

PERIODICALS

Annual Review of Phytopathology

Excellent summaries of major topics.

Biocontrol Science and Technology

Presents original research and reviews in the fields of biological pest, disease and weed control.

IPM Practitioner

Focuses on management alternatives for pests such as insects, mites, ticks, vertebrates, weeds and plant pathogens.

Journal of Sustainable Agriculture

Basic research on social and agronomic aspects of sustainable agriculture.

Microbial Ecology

International forum for the presentation of high-quality scientific investigations of how microorganisms interact with their environment, with each other and with their hosts.

Organic Farming Research Foundation Reports

Summarizes research projects (many by growers) on practical organic farming topics, including pest and disease control.

Phytopathology

Primary research journal.

Plant Disease

Primary practical research journal.

WEB-BASED RESOURCES

Agriculture Research Service Biological Control of Plant Diseases

www.ars.usda.gov/research/programs.htm

See the Crop Production and Protection programs for descriptions and reports of USDA-funded research on pests and disease control.

American Phytopathological Society

apsnet.org

The Education section covers many specific plant pathogens and overall concepts. Includes a reference list of books, websites, videos, etc. The Illustrated Glossary provides definitions and illustrations of many technical terms used in plant pathology. The article on the Plant Disease Doughnut (<http://www.apsnet.org/edcenter/instcomm/TeachingArticles/Pages/PlantDiseaseDoughnut.aspx>) provides a useful graphic to describe the difference between a disease and a pathogen.

California Pest Management Guidelines

www.ipm.ucdavis.edu/IPMPROJECT/pubsmenu.html

Official guidelines for pest monitoring techniques, pesticides, and nonpesticide alternatives for managing insect, mite, nematode, weed, and disease pests in agricultural crops, floriculture and ornamental nurseries, commercial turf, and in homes and landscapes.

Consortium for International Crop Protection, IPMnet

www.ipmnet.org

New research, links, bulletin board, newsletter, based out of Oregon State University.

New York State/Cornell IPM Program

www.nysipm.cornell.edu

Valuable resource covering many fruit and vegetable crops, including identification information, cultural practices and inputs to manage pests and diseases.

North Carolina State University Center for Integrated Pest Management

www.cipm.info/

Database of resources on pest management in North Carolina.

Pacific Northwest Plant Disease Management Handbook

pnwhandbooks.org/plantdisease

This handbook is intended as a ready reference guide to the control and management tactics for the more important plant diseases in the Pacific Northwest.

UC Sustainable Agriculture Research and Education Program

www.sarep.ucdavis.edu

Includes reports and resources on organic farming and on SAREP-funded research projects, including Biologically Integrated Farming Systems (BIFS). See the SAREP-funded Projects Database.

SUPPLEMENT 1

The Importance of Farmer-to-Farmer Social Networks

The three key factors that interact to determine plant pathogen activity in crops are susceptible host, virulent pathogen, and environmental conditions. As described in the lecture, the goal of an organic farming system is to slow down, reduce, or avoid disease problems by designing the system to be resilient and unfavorable to pathogens. Knowledge of local disease pressures and prevention practices shared amongst farmers can be an important element in developing a disease-resistant farming system.

Of the three factors illustrated by the disease triangle, organic systems have influence over, and sometimes focus on, environmental and growing conditions. By contrast, conventional systems often focus on trying to eliminate individual pathogens through chemical control. Because certified organic growers have few options for approved chemical controls (e.g., copper, sulfur, neem), synergistic environmental and host controls are implemented to reduce or avoid the potential for an outbreak in the first place.

The techniques and methods one implements in an ecological system to deter plant diseases from causing significant damage vary based on several factors, including: geography, climate, soil type, and baseline presence of the pathogen. Strong, healthy plants in microbiologically active soils provide farmers with a helpful ecological defense to disease. Selecting crops well suited to local soil and climatic conditions is thus important to building a resilient system. Season by season, farmers who select and save seeds from their most disease-resistant individual plants actively build a stronger defense against pathogen pressures. Similarly, building soil health with regular additions of compost and cover crops helps support high levels of microbial activity in soils, which may act as a deterrent and competitive force against disease-causing bacteria and fungi. Local conditions also dictate the likely presence of a disease. For example, places where cool nights and morning dew persist (e.g., coastal California) provide more favorable conditions to downy mildew than a dry, warm climate (e.g., Texas). Being informed by place is both a part of the agroecological philosophy as well as a practical skill

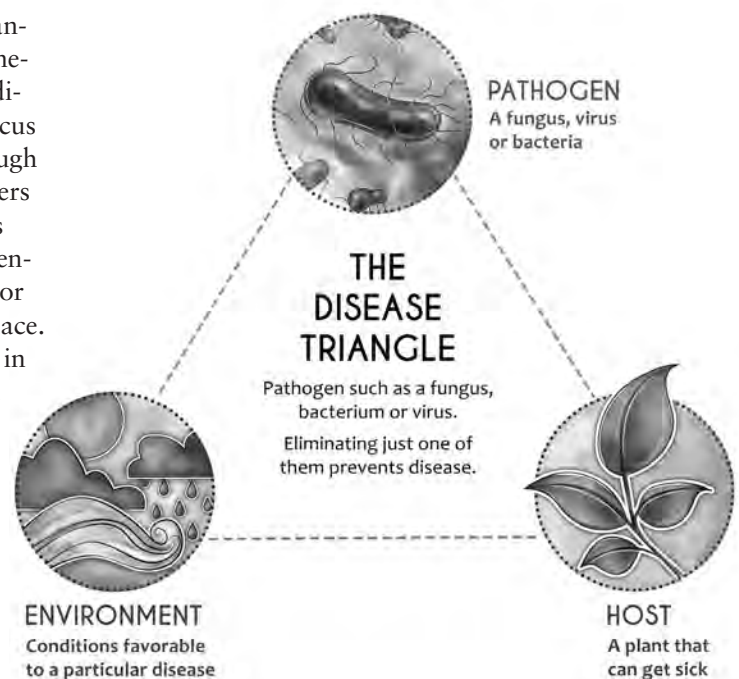

Illustration by José Miguel Mayo

that farmers need to continually develop in order to effectively manage pests and diseases.

For new farmers, and those who move to new climates, acquiring this knowledge may be challenging. Previously learned techniques and methods from farming experiences in other locations may not always be applicable. Counties may have university-supported agricultural extension offices that offer publications on pest and pathogen management, although these resources are often geared toward a handful of commodity crops. Local cooperative extension offices mostly offer resources for conven-

tional agriculture throughout the country, and may not be able to provide information specifically for organic systems. Federal research funding is often inadequate to support research and development for pest and pathogen management in these systems, so extension staff members may not be able to prioritize this kind of research. The location-specific nature of agroecological pathogen management and the limited availability of extension services in some areas means that established local farmers are often the best resources for new farmers on information about diseases in the area and locally adapted management techniques.

Benefits of Experiential Learning

Farmers, more so than most, benefit greatly from experiential learning. Climate, precipitation, soil nutrient availability, and seed viability are just a handful of important variables that affect crop growth and disease presence and are subject to change each season. The collective experience of a local community of farmers with these variables will always dwarf any individual's experience in the same season. For this reason, sharing experiential knowledge with other farmers, new and old, is an important aspect of the practice of agroecology and organic farming.

From this perspective, each farmer's season growing a particular crop, say beets, is a "field trial" from which that farmer learns about his or her successes and failures in controlling pests and diseases. Taken together, a local community of beet farmers offers a wealth of knowledge on beet pest and disease management that stands to benefit all. Even in a competitive economy, sharing best practices for disease management creates mutual benefits for neighboring farmers because disease pressure on one plot (especially highly mobile bacteria and fungi) threatens every plot within that pathogen's range of mobility. Since organic systems rely more on prevention than treatment, maintaining the integrity of the system is paramount for effective disease management.

In addition to the disease management benefits of farmer-to-farmer networks, there is another important reason for these connections—empowerment. The budding Farmers' Guild network in California (www.farmersguild.org) is one example of this type of self-supporting, farmer-helping-farmer movement, although often these networks include mostly beginning farmers and it is important to access the knowledge of long-time farmers to be most effec-

tive. Internationally, the Movimiento Campesino a Campesino (MCAc), which started in Guatemala, provides an example of the sociopolitical importance of a strong network of small, sustainable farmers and their allies.

The MCAc began as an attempt to improve rural, smallholder farmers' livelihoods through farmer-led, sustainable agricultural development, long before the term was coined in international discourse. As a result of the Green Revolution, increasing national debt, and reduced government support for traditional agriculture, campesinos (or peasant farmers) turned to each other for support and development assistance. Through loosely organized networks, farmers who learned successful cultivation, fertility, and irrigation techniques taught others the same methods. These farmers freely chose to adopt or ignore the techniques, depending on their local conditions. If adopted and successful, the second group would pass the techniques on to another set of farmers, and so on. After thirty years, the MCAc has transitioned from a practical training network into an international social movement for equity and the rights of smallholder farmers and against destruction of soil, water, and genetic diversity.

The significance of knowledge discovered and shared locally cannot be overestimated. After years of marginalization by colonizers, government actors, private firms, or large landowners, campesino communities often exhibit distrust of outsiders, even those with good intentions. The MCAc, and others like it, formed and carried on by campesinos themselves, is self-empowering and provides a path towards independence and self-sustainability.

Still, sustainable agriculture is the alternative, not the dominant system that guides resource distribution, and trade and environmental policy. Beyond spreading the practice of sustainable agricultural development, the MCAc must cultivate social, economic, and political power to change the institutions that shape agriculture. This will require new knowledge to be disseminated through the same farmer-to-farmer exchanges that brought sustainable practices to so many smallholder farmers in developing countries at the outset.

There will also have to be much more education of citizens in developed countries, where much of the national debt of developing countries is held and significantly impacts agricultural policy of debtor nations (see Lecture 2 in Unit 3.1, Development of

U.S. Agriculture). As one campesino puts it, “I think we should not fall in the trap of seeing the development of agroecology by just looking at the physical aspects of the farm or just at the economics. Agroecology is not just a collection of practices. [It] is a way of life.”

More information on farmer-to-farmer networks—

Holt-Gimenez, Eric. 2006. *Campesino a Campesino: Voices for Latin America’s Farmer to Farmer Movement for Sustainable Agriculture*. Oakland, CA: Food First Books.

Holt-Gimenez, Eric. 2001. Scaling up sustainable agriculture: Lessons from the Campesino a Campesino movement. *LEISA Magazine*, Vol. 17 No. 3.

www.agriculturesnetwork.org/magazines/global/lessons-in-scaling-up/scaling-up-sustainable-agriculture

Managing Weeds

Introduction	395
Lecture 1: Weed Biology	397
Lecture 2: Cultural Weed Management Practices	401
Demonstration 1: Mechanical Weed Management	
Instructor's Demonstration Outline	407
Demonstration 2: Hand Weeding	
Instructor's Demonstration Outline	409
Demonstration 3: Weed Identification	
Instructor's Demonstration Outline and Lab Exercise	411
Assessment Questions and Key	413
Resources	416
Supplement 1: Strategies for Improved Weed Management on Small-Scale, Diverse Farms	419
Appendices	
1. Hand Tools for Weed Management	423
2. Tools for Mechanical Weed Management	424
3. Planting to Moisture	425
4. Pre-Irrigation to Minimize Weed Pressure	426

Introduction: Managing Weeds

UNIT OVERVIEW

Managing weeds with organically acceptable techniques is one of the biggest challenges and potentially highest labor inputs that organic growers face. This unit introduces students to the basic biology of common weed plants found in agricultural systems, and the concepts and strategies used to effectively minimize weed pressure in sustainably managed annual vegetable cropping systems.

The lecture material emphasizes field-scale weed management; garden-scale considerations are also discussed. Demonstrations address both mechanical and hand-weeding techniques and tools used in a garden or small farm setting, as well as weed identification skills. The supplement provides more detailed information on weed control options for small-scale, mixed vegetable organic operations.

MODES OF INSTRUCTION

- > LECTURES (2 LECTURES, 1.5 HOURS EACH)
 - Lecture 1 presents basic weed biology, including the problems and benefits of weeds, as well as weed classifications and factors affecting germination and dispersal.
 - Lecture 2 presents information on cultural practices commonly used in sustainable systems for weed management.
- > DEMONSTRATION 1: MECHANICAL WEED MANAGEMENT (1 HOUR)
 - The instructor's outline details how to demonstrate the various tractor-mounted tools used for field-scale cultivation of fallow and planted beds.
- > DEMONSTRATION 2: HAND WEEDING IN THE GARDEN AND SMALL FARM (1 HOUR)
 - The instructor's outline details how to demonstrate the use and maintenance of various hand tools for managing weeds in the garden and small farm.
- > DEMONSTRATION 3: WEED IDENTIFICATION LAB EXERCISE (1 HOUR)
 - With the instructor's guidance and the use of texts and web-based resources, students will learn to collect and identify common weeds at various growth stages.
- > ASSESSMENT QUESTIONS (1–2 HOURS)
 - Assessment questions reinforce key unit concepts and skills.
- > VIDEO, POWERPOINT
 - See casfs.ucsc.edu/about/publications, and click on Teaching Organic Farming & Gardening.

LEARNING OBJECTIVES

CONCEPTS

- The biology of weeds
- The need for managing weeds in cropping systems

SKILLS

- How to identify weeds
- How to design a cropping rotation specifically for weed management
- How to plant, cultivate, and irrigate crops to reduce weed pressure
- How to assess a cropping system for potential weed problems

Lecture 1: Weed Biology

Pre-Assessment Questions

1. What is a weed?
2. How are weeds dispersed?
3. What are some benefits of weeds in a cropping system?
4. What are some of the characteristics of weeds that allow them to compete so well in cropping systems?
5. Why control weeds?

A. Definition—What Is A Weed?

1. A weed is any plant, native or non-native, that interferes with crop production by competing with crops for nutrients, sunlight, and/or water and has a habit of encroaching where it is not wanted

B. Weed Problems

1. Crop competition and its effect on crop yield and quality
 - a) Nutrient competition: Weedy plants, like crop plants, use soil nutrients for growth. Weeds can outcompete crops for essential plant nutrients, resulting in lower yields and/or poor crop quality.
 - b) Light competition: Weedy plants, like crop plants, use light for growth. Weeds can outcompete crops for sunlight, resulting in lower yields and/or poor crop quality.
 - c) Water competition: Weeds can outcompete crops for water, resulting in unnecessary water use, lower yields, and/or poor crop quality
2. Interference with harvesting operations
 - a) Example: Weed roots such as bindweed wrap around sub-soil blades used for undercutting root crops during harvest
3. Allelopathic effect of weeds on crop germination and growth: Certain weedy plants produce and secrete chemical compounds that are known to retard the germination of crop seed and the growth of crop plants
4. Ability of weeds to reproduce in cropping systems: Due to the high fertility and irrigation used in agricultural soils, weedy plants can themselves produce abundant seed and create a very large seed bank in a single season
5. Weeds can harbor diseases such as viruses and plant pathogenic fungi

C. Weed Benefits

1. Enhance soil structure: Weed cover in a cropping system can enhance soil structure by protecting the soil surface from heavy rain, minimizing surface soil particle dispersion, and thus minimizing erosion
2. Improve soil tilth: Weeds can indirectly help improve soil tilth and aggregation by enhancing soil microbial activity through root exudates during growth and by providing additional residue at time of incorporation
3. Cycle nutrients: Like intentionally planted cover crops, weeds can retain mobile soil nutrients such as nitrate and prevent them from leaching during rains. Some weedy plants are able to access and concentrate certain soil nutrients making them available for subsequent crop growth.

4. Indicate soil characteristics: Certain species of weedy plants are known to grow only in soils with certain nutrient profiles, hydrology, and/or physical properties (see Start With the Soil by Grace Gurshuny)
5. Provide habitat for beneficial insects: Weeds can be important habitat for beneficial insects by providing nectar, pollen, and places to breed
6. Improve soil water infiltration: Weeds can improve soil water infiltration by providing channels for water movement from decaying roots

D. Weed Biology

1. Life-habit classification

- a) Annual: A plant that completes its life cycle (germination through death) in one year or growing season, essentially non-woody
 - i. Examples of summer annuals
 - Pigweed (*Amaranthus* spp.)
 - Lambsquarters (*Chenopodium album*)
 - Purslane (*Portulaca oleracea*)
 - ii. Examples of winter annuals
 - Common chickweed (*Stellaria media*)
 - Yellow mustard (*Brassica* spp.)
 - Annual bluegrass (*Poa annua*)
- b) Biennial: A plant that completes its life cycle (germination through death) in two years or growing seasons (generally flowering only in the second), is non-woody (at least above ground), often with a rosette the first growing season
 - i. Examples of biennials
 - Bullthistle (*Cirsium vulgare*)
 - Wild carrot (*Daucus* spp.)
 - Poison hemlock (*Conium maculatum*)
- c) Perennial: A plant that lives for a number of years, often producing seed each year once it reaches maturity
 - i. Simple perennials that reproduce by seed
 - Dandelion (*Taraxacum officinale*)
 - Curly dock (*Rumex crispus*)
 - Plantain (*Plantago* spp.)
 - ii. Creeping perennials: Reproduce by seed and asexually through rhizomes, stolons, tubers, and rootstalk
 - Johnson grass (*Sorghum halepense*)
 - Bermuda grass (*Cynodon dactylon*)
 - Nutsedge (*Cyperus* spp.)
 - Field bindweed (*Convolvulus arvensis*)

2. Plant-type classification

- a) Grasses (monocots): Members of a subclass of Angiosperms characterized by the presence of one cotyledon in their seeds
 - i. Annual bluegrass
 - ii. Johnson grass
- b) Broadleaves (dicots): Members of a subclass of Angiosperms characterized by having two cotyledons in their seeds
 - i. Pigweed
 - ii. Black mustard (*Brassica* spp.)
- c) Brushes
 - i. Coyote brush (*Baccharis pilularis*)

- d) Woody plants
 - i. Willow (*Salix* spp.)
- 3. Daylength classification
 - a) Short-day weeds: Weeds that increase in vegetative growth when days are long and flower when days are short
 - i. Lambsquarters (*Chenopodium album*)
 - b) Long-day weeds: Weeds that increase in vegetative growth when days are short and flower when days are long
 - i. Henbane (*Hyoscyamus niger*)
 - c) Day-neutral weeds: Weeds that flower under any photoperiod conditions
 - i. Nightshade (*Solanum* spp.)
- 4. Seed germination
 - a) Factors affecting seed dormancy and germination
 - i. Type of seed coat
 - ii. Temperature, moisture
 - iii. Oxygen
 - iv. Light
 - v. Presence of chemical inhibitors
- 5. Dispersal: Seed and plant movement
 - a) Weed seed dispersal mechanisms
 - i. Wind: It is critical to work with neighbors to reduce or eliminate weedy plants from surrounding areas in order to avoid wind-dispersed contamination
 - ii. Seed movement in irrigation water: Critical to have filters on irrigation system to avoid contamination
 - iii. Seed importation on farm equipment: Critical to clean equipment when moving from one field to another or borrowing equipment
 - iv. Seed importation through compost and animal manures: Critical to thoroughly compost materials aerobically prior to application while sustaining temperatures of 131°F+ for a minimum of 15 days
 - v. Movement facilitated by birds, gophers, and other animals
 - vi. Use of contaminated crop seed: Critical to check seed source for percent pure seed. Always use high quality seed supply.

Lecture 2: Cultural Weed Management Practices

Pre-Assessment Questions

1. What steps can be taken to minimize weed seed dispersal?
2. How can crop rotations be used to minimize weed pressure?
3. What tools do growers use to mechanically control weeds?

A. Weed Prevention Strategies (see also Supplement 1, Strategies for Improved Weed Management on Small-Scale, Diverse Farms)

1. Improve soil tilth, aeration, water infiltration, and fertility to optimize crop growth and minimize weed pressure. Healthy agricultural soils with good tilth promote ease of weed removal by hand and/or by mechanical cultivation.
2. Thoroughly clean equipment before moving it from one farm or location to another to avoid transporting weed seeds from infested fields
3. Do not allow weeds to form seed heads and/or perennial rooting structures in the cropping system. A single season of allowing weeds to set seed may create years of weed management problems. Annual preventive clean cultivation will exhaust the existing seed bank.
4. Thoroughly compost all imported animal manures to insure destruction of viable weed seed. Aerobically composted manures and plant materials in which temperatures are sustained at 131°F+ for 15 or more days should destroy all viable weed seed.
5. Filter surface irrigation water to avoid importing weed seeds
6. Work with neighbors to eliminate or minimize the potential for spread of noxious and problematic weeds from adjacent lands

B. Crop Rotation Strategies for Optimum Weed Management

1. Rotate between summer and winter production systems. Alternating ground from winter to summer production combined with the use of weed-suppressive cover crops further exhausts the weed seed bank.
2. Use weed-suppressive cover crops in your rotation to suppress problem weeds
 - a) Examples of weed-suppressive cover crops
 - i. Sudan grass (*Sorghum bicolor*): Heat-loving summer cover crop quickly grows to 8 feet, shades other weedy plants. Prevents successful weed reproduction, exhausting seed bank.
 - ii. Buckwheat (*Fagopyrum esculentum*): A fast-growing, broad leaf summer cover crop. Quickly smothers weeds such as Canada thistle, nutgrass, quack grass, etc.
 - iii. Sesbania (*Sesbania macrocarpa*): Vigorous growth in hot summer areas, outcompetes and shades weeds
 - iv. Annual rye grass (*Lolium multiflorum*)
 - v. Perennial rye grass (*Lolium perene*): Adapted to cooler areas (e.g., Pacific Northwest). Dense growth and allelochemicals suppress germination and growth of weedy species.
3. Use smother production crops and crops that compete well with weeds when weed pressure becomes high
 - a) Examples: Corn, winter squash, potatoes
4. Optimize timing of cover crop planting to insure strong uniform growth. Uniform plantings of cover crops assures uniform ground cover and canopy of shade, reducing viability of weed populations. (See Unit 1.6, Selecting and Using Cover Crops.)

C. Tillage Strategies to Minimize Weed Pressure

1. Maintain good soil structure
 - a) Minimize the use of rototillers to maintain good aggregation. Agricultural soils with good tilth allow for ease of weed removal through hand and/or mechanical cultivation.
 - b) Work soil at optimal soil moisture content (~50% of field capacity) to avoid compaction (see Unit 1.2, Garden and Field Tillage and Cultivation)
2. Use moldboard plows selectively to bury problem weed seeds such as annual bluegrass. Deep burial of certain weeds is possible but should be done very selectively.
3. Avoid tilling perennial weeds such as Johnson and Bermuda grass
 - a) Cutting and burying perennial weeds such as Johnson and Bermuda grass with a disc or rototiller will exacerbate a weed problem by facilitating the propagation and spread of their rhizomes

D. Planting and Cultivation Techniques to Minimize Weed Pressure

1. Plant large-seeded crops (e.g., corn, beans, squash) to moisture rather than irrigating them up (see Supplement 1 and Appendix 3, Planting to Moisture). Planting such large-seeded crops to moisture and allowing the crop to become established prior to any irrigation prevents germination of weedy competitors and provides a shade canopy to further inhibit weed growth.
2. Though soil and climate dependent, many of the crops listed above can grow to near maturity without irrigation, if not completely dry-farmed (see Supplement 4, Overview of Dry Farming in Unit 1.5, Irrigation—Principles and Practices)
3. Plant straight, perfectly spaced seed lines on straight, firm, uniform beds. Uniform spacing and straight lines of production crops reduces weed pressure by allowing close mechanical cultivation, thereby reducing costs associated with hand weeding. At a garden scale, planting in straight lines allows for ease and efficiency of hoeing.
4. Use sleds or other guidance systems on all tractor-mounted planters and cultivators. These will help create straight, perfectly spaced seed lines on straight, firm, uniform beds.
5. Use transplants where practical to get a jump on weeds. Because they are larger than recently germinated weed seeds, transplants are easy to recognize when cultivating weedy ground. The larger transplants are also more mature, leading to rapid growth and successful competition with weeds.
6. Keep weed cultivations (either tractor mounted or hand held) shallow. This will avoid bringing up new weed seeds from lower soil horizons.
7. Pay close attention to soil moisture, tilth, and weed growth to optimize timing of cultivation. Both in the field and in garden settings, cultivating weeds at the right soil moisture (~50%–60% of field capacity) and at the early stages of weedy growth when surface soils are in need of aeration allows for two essential cultivation tasks to be completed simultaneously.
8. “Dirting”: Configure beds and seed lines so that dirt can be moved into the planted row with cultivation equipment on long-stemmed crops (e.g., tomatoes, potatoes, sweet corn, peppers). This “dirting” technique will effectively smother newly germinated weeds within the plant row.

E. Irrigation Techniques to Minimize Weed Pressure (see also Unit 1.5)

1. Pre-irrigate beds and lightly cultivate (either mechanically in the field or by hand in the garden) prior to planting to destroy newly germinated weeds (see Appendix 4, Pre-Irrigation to Minimize Weed Pressure). Repeated pre-irrigation and light cultivation passes may be used to exhaust the seed bank prior to planting the production crop in a known weedy area.
2. Maintain uniform irrigations to avoid areas of high water concentration. Uneven moisture will result in uneven germination and growth of weed populations, often leading to the need for repeated cultivations.
3. Use drip tape to avoid wetting the entire soil surface. Reducing the soil surface area exposed to moisture will reduce the surface area of land able to support weed populations.
4. Allow deep-rooted crops to establish deep root systems and irrigate deeply and infrequently to avoid excessive surface wetting. See above.
5. Delay irrigation following cultivation long enough to allow for weeds to desiccate. Certain weeds (e.g., purslane) may successfully re-root and grow after cultivation if irrigation reestablishes root-to-soil contact before the weeds die.

F. Fallow Period for Perennial Weed Control

1. Fallow period defined
 - a) A period of time (generally a portion of a growing season up to three growing seasons) that ground is not in crop production, but rather left bare and cultivated for weed control, or left to sit in cover crop to control weeds and improve soil health. Fallow periods are often integrated into crop rotation and crop planning strategies. E.g., in the Northeast, farmers often take fields out of production for 1–2 years, and leave them fallow in a perennial cover crop such as clover, then bring them back into crop production in year 3.
2. Use a fallow period to control problem perennials (e.g., Johnson grass, crab grass, bermuda grass)
 - a) Use a springtooth cultivator during fallow periods to bring perennial weed roots to surface to desiccate and/or freeze

G. Flame Weeding Techniques and Strategies

1. Flame weeding defined
 - a) Flame weeding involves direct application of a flame to newly emergent weeds. "Flaming" kills the weed by heating the water in the cells and bursting the cell walls. The technique dates back to the 1930s (prior to the advent of conventional herbicides), when row crop growers used kerosene as a fuel source. Today, flame weeding is done with propane. Flame weeders range from hand-held wands and human-powered push carts that span a garden bed for garden-scale applications, to multi-row, tractor-mounted units used in row crop fields.
2. How to flame weed
 - a) Pre-irrigate "stale" beds (beds that have been formed but not planted) to germinate weeds and use flame weeder to kill newly germinated broadleaf weeds prior to planting crops
 - b) Use flame weeder on beds of slow-germinating crops such as garlic and carrots after irrigation and before crop emergence to kill newly germinated broadleaf weeds
3. Results of flame weeding
 - a) Flame weeding can provide effective control of newly emergent broadleaf weeds

4. Limitations of flame weeding
 - a) Flame weeders are only effective on very small, newly germinated broadleaf weeds with no surface moisture (dew) on leaves
 - b) On heavier soils, timing of re-entry with a tractor-mounted flame weeder can be challenging, as weed emergence is directly related to soil moisture. Using a flamer when the weeds are just emerging but the soil is too wet can result in significant soil compaction from tractor and implement wheels.
 - c) Flame weeding should not be done during extremely dry, windy conditions due to fire danger
 - d) At \$3,500–\$5,000, tractor-mounted flame weeders are a significant investment

H. Soil Solarization

1. Soil solarization defined
 - a) Soil solarization is the process of covering the soil with a plastic tarp during the hottest time of the year. The top 12–18 inches of soil heat up enough to kill many types of weed seeds and seedlings, along with some pests and disease-causing organisms.
2. How to solarize
 - a) Soil must be irrigated and saturated to at least 70% of field capacity to a depth of 24 inches prior to tarping
 - b) Lay 2 ml clear plastic tarp as close to smooth soil surface as possible during warmest time of year
 - c) Plastic should be left in place for 4 to 6 weeks
 - d) Tillage deeper than 3 inches must be avoided after solarization
2. Results of solarization
 - a) Solarization controls many annual weeds, and is especially effective in controlling winter annuals
3. Limitations of soil solarization
 - a) Control of purslane, crabgrass, and many perennials may be difficult to achieve
 - b) Soil solarization is most effective in very hot summer areas (90°F+ conditions)
 - c) Cost of soil solarization over large acreage may be prohibitive
 - d) Soil solarization requires the use of petroleum-based plastic tarps that cannot be reused and are challenging to recycle

I. Weed-Suppressive Mulches

1. Weed-suppressive mulches defined
 - a) Mulching involves covering the soil with organic or synthetic materials to keep weed seeds from germinating by blocking light and preventing seed-soil contact
2. Types of mulches
 - a) Dark plastic mulches can be used as a weed-suppressive mulch in many cropping systems
 - i. Example: Strawberries
 - b) Organic mulches such as straw, woodchips, sawdust, or cardboard
 - i. Examples: Tomatoes are often mulched with straw. Fruit trees are often mulched with woodchips. Cardboard covered by a layer of woodchips can suppress weeds, particularly in perennial plantings.

- c) Living mulches: Intercropping with a cover crop in main season crop can prevent erosion and limit weed growth. Living mulches are important in low- and no-till systems to suppress weed growth during the cropping season (see Unit 1.2, Garden and Field Tillage and Cultivation).
3. Results of weed suppressive mulches
 - a) Effectively inhibit growth of most weeds if applied as a thick layer (3" or more if using organic materials)
 - b) Keeps soil cool
 - c) Minimizes water loss
 4. Limitations of weed suppressive mulches
 - a) Potential problems with fungal diseases, especially if applied too close to stems or tree trunks
 - b) May harbor snails, slugs, and other pests
 - c) Labor intensive to apply
 - d) Purchasing mulch increases input costs

Demonstration 1: Mechanical Weed Management

for the instructor

OVERVIEW

For this field demonstration, the instructor should have access to a wide range of tractor-mounted or drawn tillage and cultivating implements and the appropriate tractors for each of the implements. It also requires access to tillable land and existing diverse cropping systems and/or formed fallow beds spaced to match the equipment.

PREPARATION AND MATERIALS

Implements and tractors used in the demonstration should be set up adjacent to the demonstration site and parked to allow fast hook up and drop off.

PREPARATION TIME

0.5 hour

DEMONSTRATION TIME

1 hour

DEMONSTRATION OUTLINE

A. Demonstration of Row Crop Cultivation Implements

1. Examine lister bar, markers, and shovels
 - a) Explain the use of listers for bed formation
 - b) Discuss other options for forming beds
 - c) Explain the use of bed shapers
2. Do a field demonstration of a rolling cultivator
 - a) Run rolling cultivator down fallow beds
 - b) Discuss the various uses of the rolling cultivators for weed management in fallow and cropped systems
3. Do a field demonstration of a row crop cultivator set up with sweeps and knives
 - a) Run cultivator down crop row
 - b) Discuss the various components of cultivator operation and set up

Demonstration 2: Hand Weeding in the Garden & Small Farm

for the instructor

OVERVIEW

This field demonstration provides a brief overview of the most common hand tools and techniques used to manage weeds on both a garden and small-farm scale. The instructor should have access to a wide range of hand tools for demonstrating field use and tool maintenance. The demonstration also requires access to tillable land and existing diverse cropping systems at various stages of development.

PREPARATION AND MATERIALS

- Hand tools
- Wheel hoe
- Reciprocating hoe
- Tined cultivators
- Glaser collinear hoe
- Sharpening tools (e.g., files) for hand tools
- Existing diverse cropping systems at various stages of crop development and soil moisture

PREPARATION TIME

1 hour

DEMONSTRATION TIME

2 hours

DEMONSTRATION OUTLINE

A. Environmental Factors Conducive to Weeding

1. Briefly review weed prevention strategies and environmental factors conducive to weeding (see Lecture 2, Cultural Weed Management Practices)
 - a) Soil moisture at 50% field capacity
 - b) Sunny and windy conditions are ideal

B. Tools and Techniques for Hand Weeding at the Garden and Small-Farm Scale

1. Discuss and demonstrate why hand tools are used
 - a) Tractor-mounted/mechanical weed control devices aren't able to cultivate close enough to the stem of many irrigated crops
 - i. Show students bed of crops where mechanical implements are ineffective and hand tools necessary
 - ii. Review and discuss crops and cropping strategies where hand cultivation is less necessary or is needed infrequently (e.g., dry-farmed crops or large-seeded crops planted to moisture)
 - b) Exclusive hand tool use in garden settings
2. Discuss and demonstrate the use of various hand tools
 - a) Discuss the importance of timing weed cultivation to prevent reseeding and competition for nutrients, sunlight, and water
 - b) Discuss the importance of sharp hand tools
 - i. Discuss safety and ergonomics
 - c) Discuss and demonstrate the importance of cultivating weeds and soil at proper soil moisture
 - d) Discuss the importance of cultivating weeds and soil at proper times of day to encourage weed desiccation
 - e) Demonstrate commonly used hand tools (see Appendix 1, Hand Tools for Weed Management)
 - i. Wheel hoe
 - ii. Reciprocating hoe ("hula hoe" or "stirrup hoe")
 - iii. Glaser Colinear hoe
 - iv. Hand tools, such as tined cultivators, hand hoes, and knives
3. Discuss and demonstrate maintenance and care of hand tools
 - a) Proper storage of hand tools for longevity
 - b) Sharpening of hand tools

Demonstration 3: Identification of Common Weeds

for the instructor

OVERVIEW

This demonstration introduces students to weed plant identification skills through field collection and the use of written and web-based resources for identification (see Resources section). Student will also be asked to research and share weed management information relative to the specimens collected. The instructor is encouraged to share his or her experience in managing the weed species identified.

PREPARATION AND MATERIALS

1. Gather multiple copies of printed identification guides (see Resources section).
2. Organize lab room with multiple computer stations for accessing web-based identification resources (see Resources section).
3. Ask students to gather as many unknown weedy plants as possible from gardens or fields.
4. Have students work in pairs to identify the common name of each of the weeds as well as gather cultural information regarding the management of each species. Cultural information on each specimen should include the following: Genus and species; life habit classification; soil indications; reproductive strategy; cultural controls for organic systems.

PREPARATION TIME

1 hour

DEMONSTRATION/LAB TIME

2 hours

DEMONSTRATION OUTLINE

A. Review the Identification Process

1. Ask student to share the name of the plant and the identifying characteristics
2. Identification is confirmed with other students and instructor
3. Instructor reviews identifying characteristics, if necessary

B. Ask Students to Share Additional Cultural Information

1. Where weed was found/habitat
2. Genus and species of weed
3. Life habit classification of weed
4. Soil physical or chemical properties as indicated by presence of particular weed species
5. Reproductive strategy and dispersal of weed
6. Cultural controls for organic systems

C. Instructor Shares His or Her Experience in Managing the Weed Species Identified

Assessment Questions

- 1) Describe common problems associated with the unmanaged growth of weedy plant species in the garden or farm.

- 2) What are five ways by which weed seeds are dispersed? Describe five preventive measures that may be used to avoid the dispersal of weed seeds in the garden and farm.

- 3) Describe two ways that crop rotation may be used to control weeds in organic farming systems.

- 4) Describe five planting and/or cultivation techniques used to minimize weed pressure.

- 5) Describe three irrigation techniques that may be used to minimize weed pressure in organic farming systems.

- 6) Describe three additional weed management techniques, how they function, and how they may be used in organic farming systems.

Assessment Questions Key

- 1) Describe common problems associated with the unmanaged growth of weedy plant species in the garden or farm.
 - *Crop competition for nutrients, water, and light*
 - *Interference with harvesting operations*
 - *Allelopathic effects on crop*
 - *Ability of weeds to rapidly reproduce in cropping systems*
 - *Weeds can harbor diseases and pests*
- 2) What are five ways through which weed seeds are dispersed? Describe five preventive measures that may be used to avoid the dispersal of weed seeds in the garden and farm.
 - *Wind: Manage vegetation prior to seed maturation; work with neighbors to minimize weed seed sources*
 - *Irrigation water: Water filter on irrigation equipment*
 - *Importation on farm equipment: Clean equipment before transporting to new fields*
 - *Compost and animal manure: Thoroughly aerobically compost all manure at high temperatures*
 - *Facilitated by birds, gophers, and other animals*
 - *Contaminated crop seed: Select certified seed with low weed seed content*
- 3) Describe two ways that crop rotation may be used to control weeds in organic farming systems.
 - *Smother crops and crops that compete well with weeds, e.g., corn, winter squash, potatoes*
 - *Weed-suppressive annual cover crops*
 - *Weed-suppressive perennial cover crops in rotation*
 - *Optimize timing of cover crop planting to insure strong uniform growth and a weed suppressive cover*
- 4) Describe five planting and/or cultivation techniques used to minimize weed pressure.
 - *Plant large-seeded crops to moisture*
 - *Plant straight, perfectly spaced seed lines on straight, firm, uniform beds to facilitate cultivation*
 - *Use sleds or other guidance systems on all tractor mounted planters and cultivators to assure uniform spacing, ease of close cultivation and “dirting”*
 - *Use transplants, where practical, to get a jump on weeds*
 - *Keep weed cultivations (tractor mounted or hand held) shallow to avoid bringing up new weed seeds*
 - *Timing of cultivation: Soil moisture, tilth, and weed growth. Cultivation should precede irrigation by enough time to assure desiccation of weeds. Good tilth allows for ease of weed removal; compacted soils encourage the growth of certain noxious weeds. Cultivation should precede weed seed maturity.*
- 5) Describe three irrigation techniques that may be used to minimize weed pressure in organic farming systems.
 - *Pre-irrigate beds and lightly cultivate prior to planting*
 - *Use drip tape to avoid wetting the entire soil surface*
 - *Allow deep-rooted crops to establish deep root systems and irrigate deep and infrequently to avoid excessive surface wetting*

6) Describe three additional weed management techniques, how they function, and how they may be used in organic farming systems.

- *Irrigate stale beds (beds that have been formed but not planted) to germinate weeds and use flame weeder to kill newly germinated broadleaf weeds prior to planting crops*
- *Use flamer on beds of slow-germinating crops such as garlic and carrots after irrigation and before crop emergence to kill newly germinated broadleaf weeds*
- *Soil solarization suppresses weeds by elevating soil temperatures high enough to kill weed seeds*
- *Dark plastic mulches suppress weeds by blocking light and as a physical barrier*

Resources

PRINT RESOURCES

Bowman, Gregg (ed.). 2001. *Steel in the Field: A Farmer's Guide to Weed Management Tools*. Handbook Series Book 2. Burlington, VT: Sustainable Agriculture Network. www.sare.org/Learning-Center/Books/Steel-in-the-Field

Includes drawings and explanations of numerous tractor implements used for mechanical weed management in sustainable cropping systems. Grower narratives give information on specific applications.

Ditomaso, Joseph M. 2007. *Weeds of California and Other Western States*. Publication 3488. Oakland, CA: University of California Division of Agriculture and Natural Resources

This encyclopedic yet easy-to-use 2-volume set covers 262 individual entries, including a full description of 451 species and another 361 plants compared as similar species, representing 63 plant families. Includes color photos of seeds, seedlings, flowers and mature plants.

Finney, Denise M., and Nancy G. Creamer. 2008. *Weed Management on Organic Farms. Special Topic: Cultivation Practices for Organic Crops*. Center for Environmental Farming Systems. North Carolina Cooperative Extension Service. www.cefs.ncsu.edu/resources/organicproductionguide/weedmgmtjan808accessible.pdf

Excellent 28-page publication on weed control strategies for organic farms based on weed characteristics and an integrated cropping strategy. Details various weed prevention strategies, addresses cultivation practices, includes photos of cultivation implements, and discusses options such as weed geese and organically approved herbicides.

Fischer, Bill (ed.). 1998. *Grower's Weed Identification Handbook*. Publication 4030. Oakland, CA: University of California Division of Agriculture and Natural Resources.

Detailed identification plates of over 311 California weed species.

Gershuny, Grace. 1997. *Start with the Soil*. Emmaus, PA: Rodale Press.

Includes a discussion of weeds as indicators of soil physical and chemical properties.

Smith, Richard, W. Thomas Lanini, Mark Gaskell, Jeff Mitchell, Steven Koike, and Calvin Fouche. 2000. *Weed Management for Organic Crops*. Publication 7250. Oakland, CA: University of California Division of Agriculture and Natural Resources.

Information on cultural practices, cultivation, flammers, soil sterilization, mulches, beneficial organisms, and chemical control of weeds.

Sullivan, Preston. 2003. *Principles of Sustainable Weed Management for Croplands*. National Center for Appropriate Technology (NCAT).

15-page publication discusses several alternatives to conventional tillage systems, including allelopathy, intercropping, crop rotations, and a weed-free cropping design.

Whitson, Tom (ed.). 2000. *Weeds of the West, Fifth Edition*. Laramie, WY: Western Society of Weed Science and the University of Wyoming Cooperative Extension Service.

900 photographs of over 350 weed species of Arizona, California, Colorado, Hawaii, Idaho, Montana, Nevada, New Mexico, Oregon, Utah, Washington and Wyoming.

WEB-BASED RESOURCES

California Weed Science Society (CWSS)

www.cwss.org

CWSS promotes environmentally sound proactive research and develops educational programs in weed science, as well as educational activities to promote integrated weed management systems.

eXtension. Bring Existing Weeds Under Control Before Planting Weed Sensitive Crops.

www.extension.org/pages/18549/bring-existing-weeds-under-control-before-planting-weed-sensitive-crops#.VGE5DPTF9dE

eXtension. Design the Cropping System and Select Tools for Effective Weed Control

www.extension.org/pages/18531/design-the-cropping-system-and-select-tools-for-effective-weed-control

Webinar presentations by Mark Schonbeck of the Virginia Association for Biological Farming

eXtension. Weed Identification Tools and Techniques

www.extension.org/pages/32635/weed-identification-tools-and-techniques#.VMgQWGTF_v5

Online guide offers tools and techniques for identifying weed species. Includes a basic illustrated glossary of plant identification terms.

UC Cooperative Extension, Ventura County: An Alternative Weed Control – Mulching

ceventura.ucanr.edu/Com_Ag/Subtropical/Citrus/Weeds/An_Alternative_Weed_Control_-_Mulching_/

UC Cooperative Extension specialist Nick Sakovich describes the advantages of organic mulches in orchard systems.

UC Integrated Pest Management Program

www.ipm.ucdavis.edu

Contains extensive information on IPM, including weed identification and management.

University of Vermont Extension

www.uvm.edu/vtvegandberry/factsheets/orgweedconrtol.html

The fact sheet Ten Steps Toward Organic Weed Control provides a concise, practical ten-step approach to controlling weeds in diverse organic vegetable systems, based on small- and medium-scale Vermont growers' experiences.

Western Society of Weed Science (WSWS)

www.wsweedsociety.org

WSWS works to promote weed science research and education; site includes job announcements, upcoming meetings, and links to additional weed management information.

SUPPLEMENT 1

Strategies for Improved Weed Management on Small-Scale, Diverse Farms

Good weed management is critical to the financial success of small-scale diverse organic farms. In most cases, labor costs associated with hand weeding vegetable crops can be avoided or minimized by following a set of production practices outlined below. These practices are designed to both control weeds in the short term and diminish weed pressure over time by reducing the weed seedbank.

Avoiding Weed Seed Set

The most effective way to minimize weed pressure is to never let a weed set seed in the production system, where it will add to the weed seedbank and compete directly with your crops once conditions are right for germination. For this reason it is critical to reduce the seedbank as much as possible, both prior to planting out your crops in order to start the season with a “clean slate,” as well as following harvest. This can be especially challenging for small-scale producers in highly diverse cropping systems—particularly growers with limited access to effective tractor-mounted implements for tillage, bed forming, planting, and follow-up cultivation.

Commonly, a few “escaped” weeds that have grown along side your crop will continue to mature and set seeds after the crop has been harvested and prior to crop mow-down and tillage. In diverse systems this is particularly problematic because crops of various maturation windows are often sown in blocks, making it difficult to get in and till two lines of a quick-maturing crop that is directly adjacent to a crop with a longer maturation rate. For this reason it is essential to plan production blocks that are as uniformly matched, in terms of maturation, as possible.

If different maturation times within a block are unavoidable, then it is especially important to use set row configurations that match your implement selection to allow for post-harvest mowing and tilling of specific crop rows within a production block in order to minimize weed set following harvest. Tools that facilitate knock-down of specific rows within a block include the flail mower, the under-cutter, and either a bed recycling disc or a rototiller. All of these tools need to be closely matched to your bed configuration to minimize damage to adjacent crops and to effectively destroy escaped weeds.

Cover Cropping and Smother Cropping

A much-overlooked practice that can effectively limit weed seed production is the timely and careful preparation of cover crop seedbeds and the use of fast-growing cover crops planted at higher than normal seeding rates. These dense stands of cover crops (often referred to as “smother crops”) can effectively outcompete weeds for light, water, and nutrients. Examples of highly competitive cover crops include cereal rye, mustard, and Sudan grass. Sudan grass is not cold tolerant and requires high temperatures for good growth, so it may not be suitable for cooler climates even during summer months.

Timing in terms of soil preparation, soil temperature, and soil moisture is critical when planting fall cover crops (see Unit 1.6, Supplement 2, Cover Crop Selection, Planting Tips, Tools and Techniques for additional details). Timing is especially important on farms with heavier soils in areas that receive high winter rainfall. Good soil preparation prior to planting cover crops is needed to provide adequate infiltration and deep percolation of winter rains.

Early rains can set back cover crop planting times; on the positive side they often provide the benefit of germinating the first flush of weeds. If timing is good the cover crop can be planted into well-prepared soil following the first significant rainfall event. The challenge, especially on heavier ground, is finding the right window to get back on the ground, till out the germinated weeds, and plant the cover crops without risking compaction issues related to tractor traffic.

The other challenge associated with fall planting is that as the soil starts to cool down in the fall the winter weeds have a distinct germination advantage compared to the cover crop seed. Generally speaking, the later the cover crop is planted the higher the potential for weed problems. The optimal time to plant

fall cover crops here on the Central Coast is in the last two weeks of October. Although it can be difficult for small, diversified growers to make time to plant cover crops while also dealing with the demands of irrigation, harvest and sales, good weed management related to fall cover cropping will save time overall.

Note that a less-than-optimal stand of winter cover crop can allow for extensive weed growth and subsequent weed seed production. These weed seeds can persist in the seed bank for years, adding significantly to weed management costs over time.

Legume-cereal cover crops are often popular cover crops with small scale diverse organic farms, but can also exacerbate weed management if they are planted at standard seeding rate (i.e., 125 lb/acre) that allow weed seed production. Typical legume-cereal mixes should be planted at two times or higher seeding rates to suppress weeds effectively. However, planting these mixtures at higher rates that will suppress weeds can significantly increase the cost of cover cropping. See www.youtube.com/watch?v=WREmHajFbc for additional information.

Crop Rotation

Crop rotation can be an effective tool for minimizing weed pressure on small-scale farms. There are numerous examples of effective crop rotations and the concepts involved in the design of a good rotation are fairly straightforward. If you are familiar with the weed issues in specific areas of your farm you can simply avoid planting crops that are “weed challenged” in areas that have higher weed pressure. In other words don’t plant carrots on the same block in which the “escaped” amaranth set seed last season. Instead, plant corn and potatoes in that block or plant a highly competitive “smother” crop (see above).

Fallowing

Fallow periods are absolutely critical for the eradication of problem perennial weeds in organic systems. The best example is either summer or winter fallow to control Bermuda grass and/or Johnson grass. Both of these perennial grasses have shallow rhizomes that can be easily controlled through desiccation from exposure to summer sun or freezing temperatures.

Note that discing and/or rototilling to try and control Bermuda or Johnson grass are strongly discouraged. Cutting and burying the weeds will simply facilitate the propagation and spread of their rhizomes.

Though difficult to eradicate entirely, morning glory, oxalis, and nutsedge plants can be effectively reduced in vigor over time through fallow periods in conjunction with tillage and/or undercutting to continually reduce the plants’ photosynthetic capability. This will eventually drain the plants’ rooting structure of the carbohydrate reserve it needs to propagate and grow. Eradication of these weeds can take many years of persistent fallow management coupled with the intensive use of smother crops.

Irrigation Frequency and Duration

Irrigation techniques can have an impact on weed growth and development. In general, weed seeds germinate more readily when surface soil is kept closer to field capacity; thus frequent, shallow overhead irrigations often results in higher weed seed germination. Watering less often and deeper can reduce weed seed germination. For the same reason, good uniformity of application is critical for good weed management.

Pre-Irrigation

Numerous field trials have demonstrated the efficacy of pre-irrigation as a way to reduce the weed seed bank in organic farming. A draw back to pre-irrigation is that it creates additional costs related to water use, labor, and land out of production. In heavier soils pre-irrigation is sometimes impractical due to the potentially slow dry down time.

It can also be difficult to apply enough water during pre-irrigation to effectively germinate the majority of the weed seeds within the seedbed. Often weed seeds will germinate more readily in soil moisture conditions at or near field capacity.

If a grower can form beds and apply adequate irrigation water for good seed bank germination, there are two common ways to manage weeds after they emerge: flaming, and very shallow cultivation, preferably with an under cutter followed by a crust breaker. It is critical to destroy the weeds when they are newly emerged, and they need to desiccate adequately for good kill prior to planting the cash crop.

Minimizing soil disturbance is also important when attempting to mechanically destroy newly emerged weed seed; the more the soil is disturbed, the higher the risk of bringing new weed seed up from lower in the soil into a position favorable for germination.

Pre-irrigation to “flush” weeds prior to planting crops is usually done in the springtime heading into summer production or in late summer heading into fall production. The challenge with this timing is that soil temperatures are difficult to predict: spring soil temperatures can remain low enough during pre-irrigation that the summer annual weeds aren’t stimulated to germinate; similarly, in the late summer the soil temperatures are still too high to germinate the fall annual weeds.

Drip Irrigation

Drip irrigation can be a tremendous aid in minimizing weed pressure, as the surface wetting from the drip emitters is limited to a small percentage of the overall soil surface. Where there is no surface wetting there is little opportunity for weed seed germination and growth. Use of drip irrigation is particularly effective in areas with limited summer rainfall.

Drip irrigation can also be used for pre-irrigation, but there are significant labor costs associated with laying out and retrieving the drip lines. However, in intensive small-scale mechanized production systems with limited water resources, pre-irrigation with drip is an effective weed management tool. Soil compaction is minimized, and it is easier to get a more thorough weed flush since the grower can easily maintain field capacity to optimize weed seed germination within the area to be planted without sacrificing the ability get back into the field for crop planting.

Planting to Moisture (see Appendix 3)

This often-overlooked planting technique is an effective way to minimize weed competition when planting large-seeded crops such as corn, beans, squash, and some cover crops, especially in California’s Mediterranean climate. Here is a suggested sequence for planting to moisture:

1. Form beds
2. Pre-irrigate
3. Wait for weed flush and re-work beds with rolling cultivator
4. Knock dry soil off bed tops and precision plant large seeds into residual moisture
5. Lay drip line in seed line after crop emergence
6. Wait as long as possible for crops to establish prior to first irrigation
7. Cover drip line with rolling cultivator prior to first irrigation and before crop is too tall to cultivate

Planting large-seeded crops to moisture also minimizes the risk of soil borne pathogens (damping off complex) that can affect their development. Damping off is more likely to occur when seeds are “irrigated up” with either overhead irrigation or drip irrigation.

In addition, planting to moisture eliminates surface crusting caused by soil surface wetting. When the moisture is right the crops respond favorably and the weeds don’t have enough moisture to germinate, leaving the production block effectively weed free.

Flame Weeding

Although not commonly practiced on large-scale organic farms, flame weeding (“flaming”) can be an effective and economical way to manage weeds on small, diverse farms and in large market gardens. When done correctly, flame weeding is fast, efficient and inexpensive relative to the cost of hand weeding.

Flame weeding provides just enough heat uniformly across the bed top to quickly heat and expand the moisture in the cell walls of the just-emerged dicot weeds, killing the dicot seedlings. Using a backpack flamer, a small grower can knock out the weeds that have germinated just prior to crop emergence, and easily diminish weed pressure in carrots and garlic crops, which often emerge after weeds have germinated.

Note that because the growing point of grasses is below the soil surface, flame weeding is not considered effective for control of grass weeds.

Transplanting (see Unit 1.4, Transplanting and Direct Seeding)

The use of transplants in a farming system has major benefits in terms of weed management. Direct seeding of small-seeded crops can be extremely challenging when weed pressure is high due to the high rate of competition and the difficulty and precision required to remove the competing weeds. Using transplants gives the grower a jump on the weeds and will often be the difference between a crop’s success and failure.

Blind Cultivation

Blind cultivation refers to the use of shallow soil disturbance (cultivation) just prior to or right after the emergence of large-seeded crops (e.g., corn, squash) or cover crops. This disturbance is often ad-

equate to kill newly germinated weeds while leaving the larger-seeded crops relatively undisturbed. The larger-seeded crops can more readily recover from the disturbance because they are planted deeper and/or have stronger stems and roots.

Tine weeders, including “finger weeders,” and rotary hoes are used for this method of weed control. Timing in terms of the growth stage of the crop and weeds is critical, often coming down to a narrow “window” of hours; soil conditions must be perfect, with minimal crusting or “cloddy-ness.” Some soils are simply not conducive to this practice. The main

objective of blind tillage is to get the weeds in the “white thread” stage, just before they emerge from the soil.

Stale Seedbeds

A “stale” seedbed is a seedbed that is prepared well in advance of the intended planting date. While “on hold” for planting the bed is either rained on or irrigated to germinate weeds, then lightly tilled to kill the weeds just prior to planting. The technique is most often used in East Coast vegetable production.

Appendix 1: Hand Tools for Weed Management

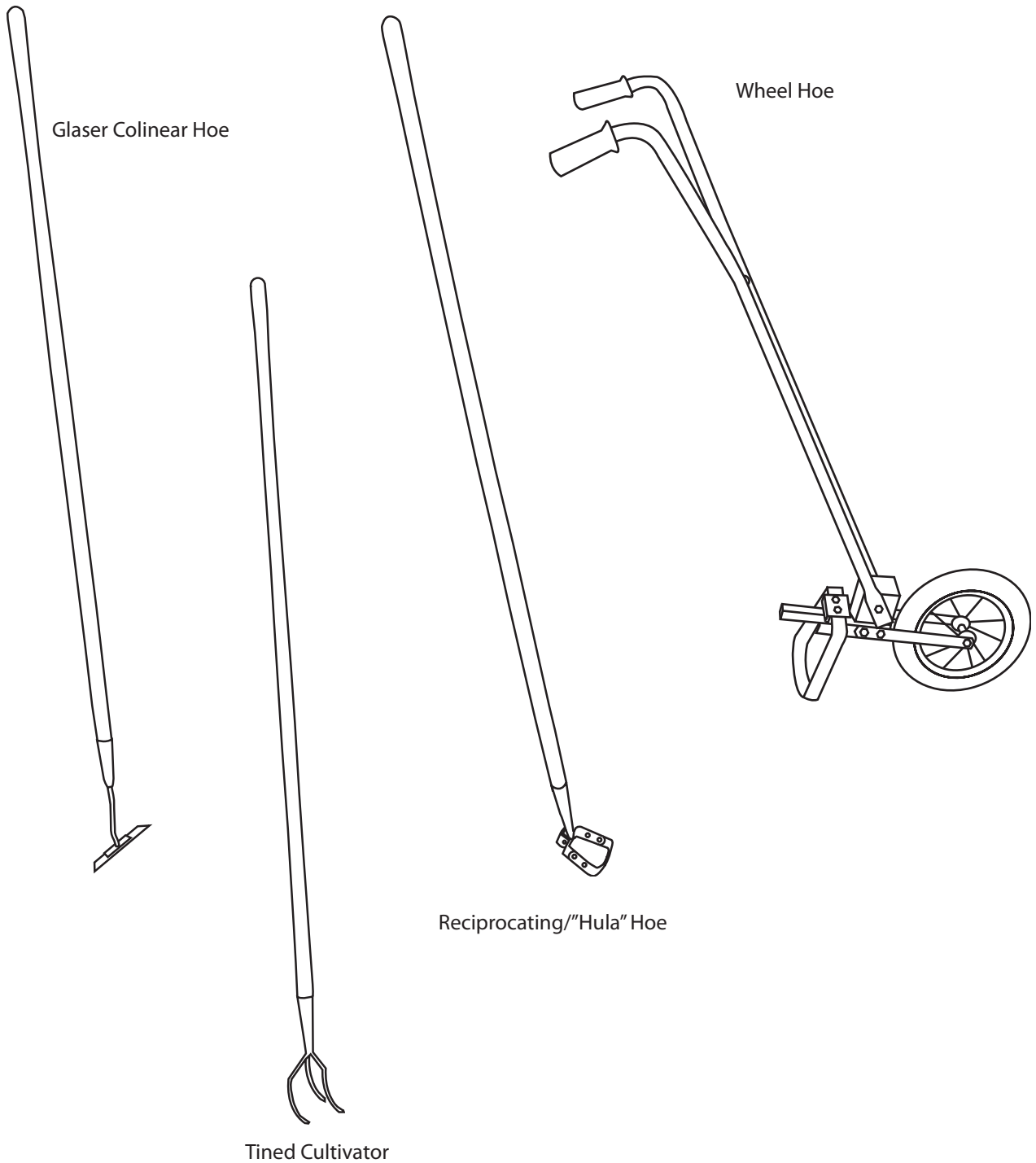

Illustrations by Cathy Genetti Reinhard; not to scale

Appendix 2: Tools for Mechanical Weed Management

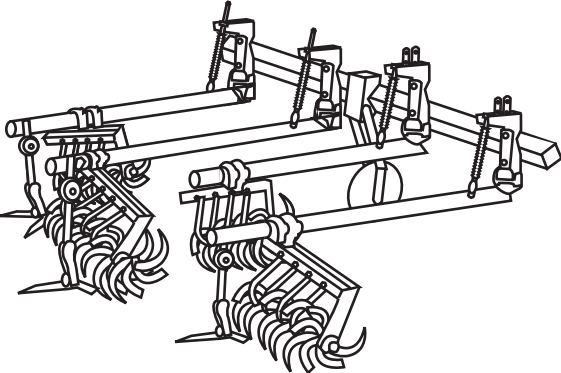

Lilliston Cultivator

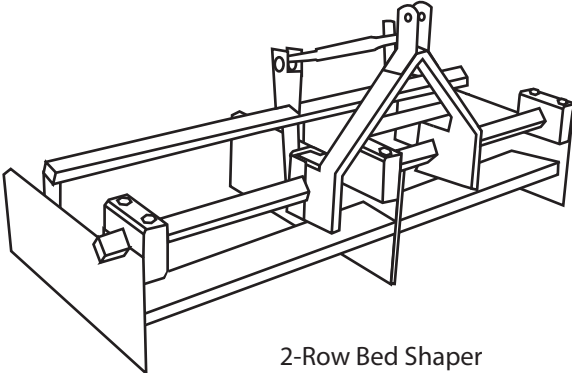

2-Row Bed Shaper

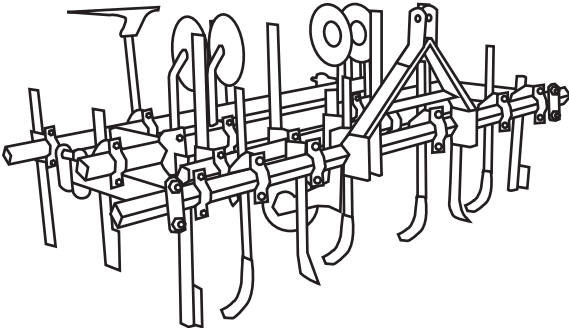

3-Bar Cultivator

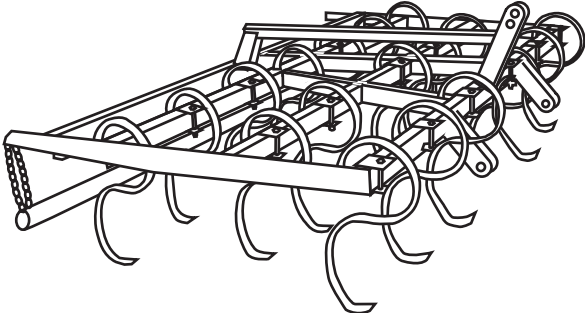

Spring-toothed Harrow

illustrations by Cathy Genetti Reinhard; not to scale

Appendix 3: Planting to Moisture

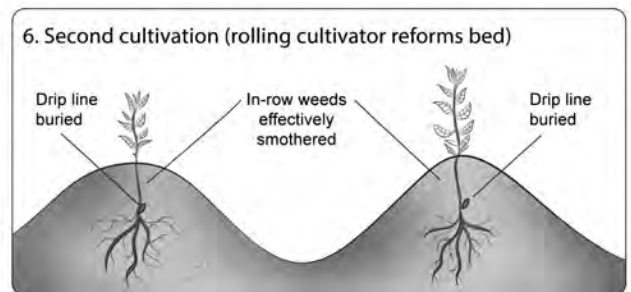
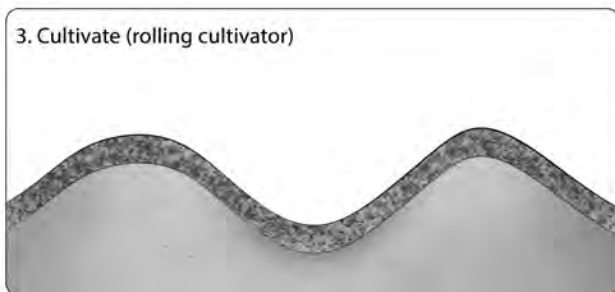
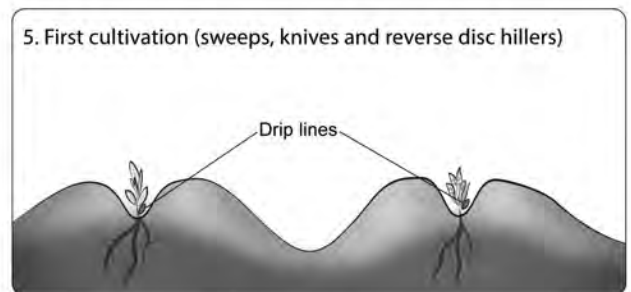
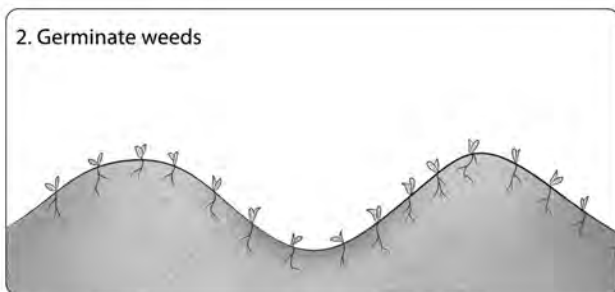
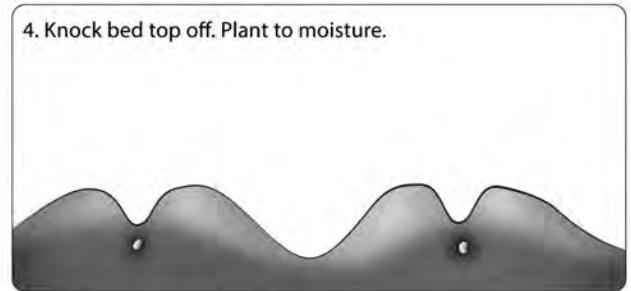
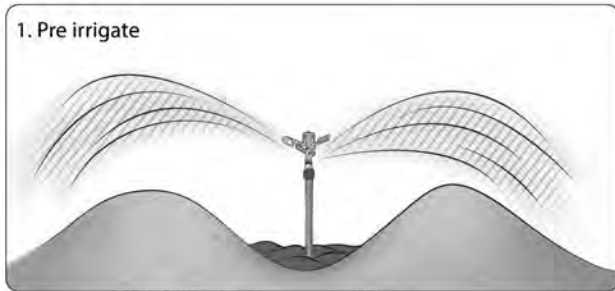

Illustrations by José Miguel Mayo

Appendix 4: Pre-Irrigation to Minimize Weed Pressure

When beds are pre-irrigated, the resulting “flush” of weeds can be easily controlled with shallow cultivation prior to crop planting and subsequent irrigation.

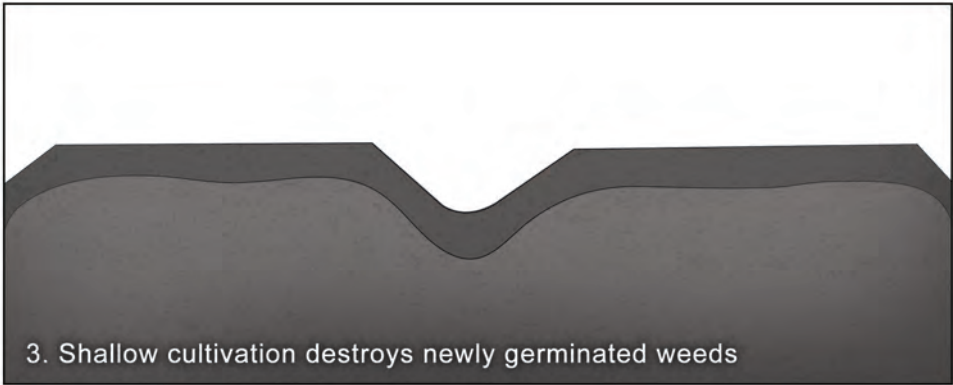
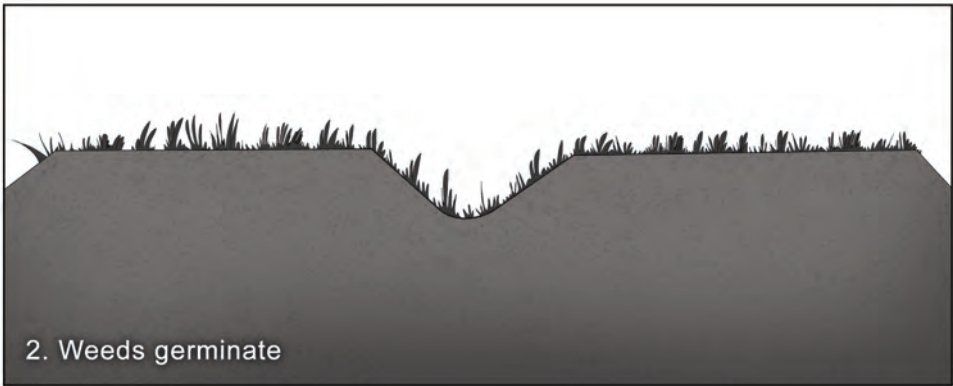

Illustrations by José Miguel Mayo

Appendix 4 (cont'd): Pre-Irrigation to Minimize Weed Pressure

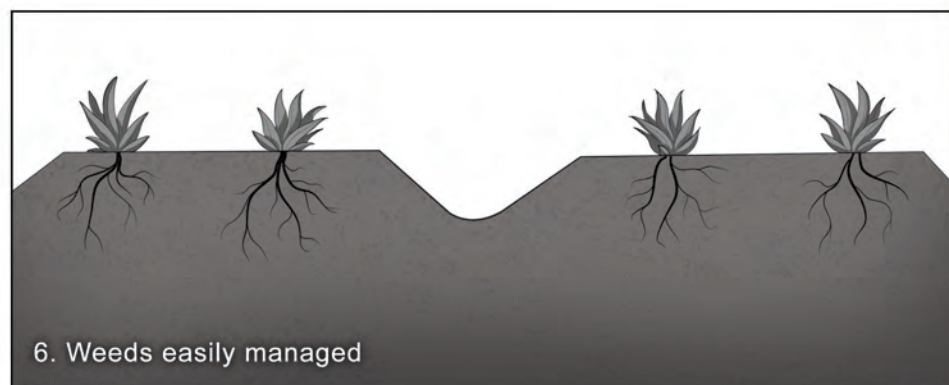
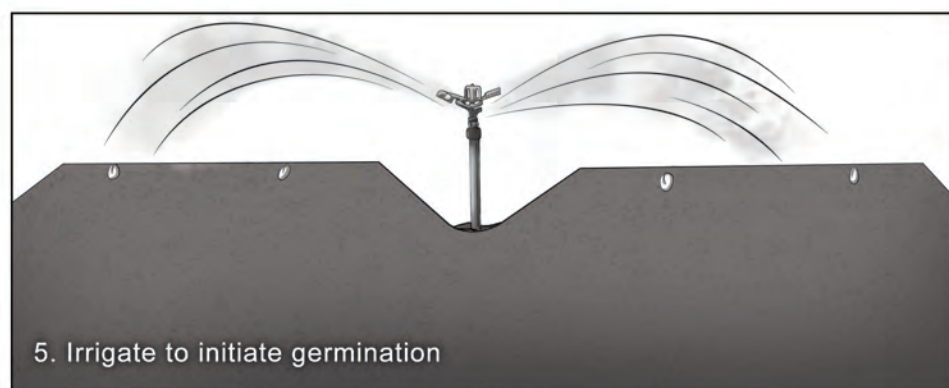
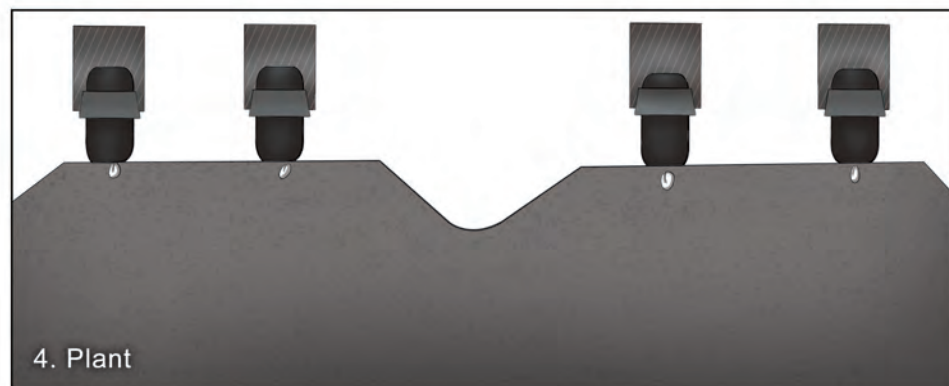

Illustrations by José Miguel Mayo

Appendix 4 (cont'd): Pre-Irrigation to Minimize Weed Pressure

Note that in contrast to the sequence illustrated on pages 426–427, if seeds are planted prior to the initial irrigation, weeds and crop plants will germinate together, increasing the amount of labor and cost required to control weeds.

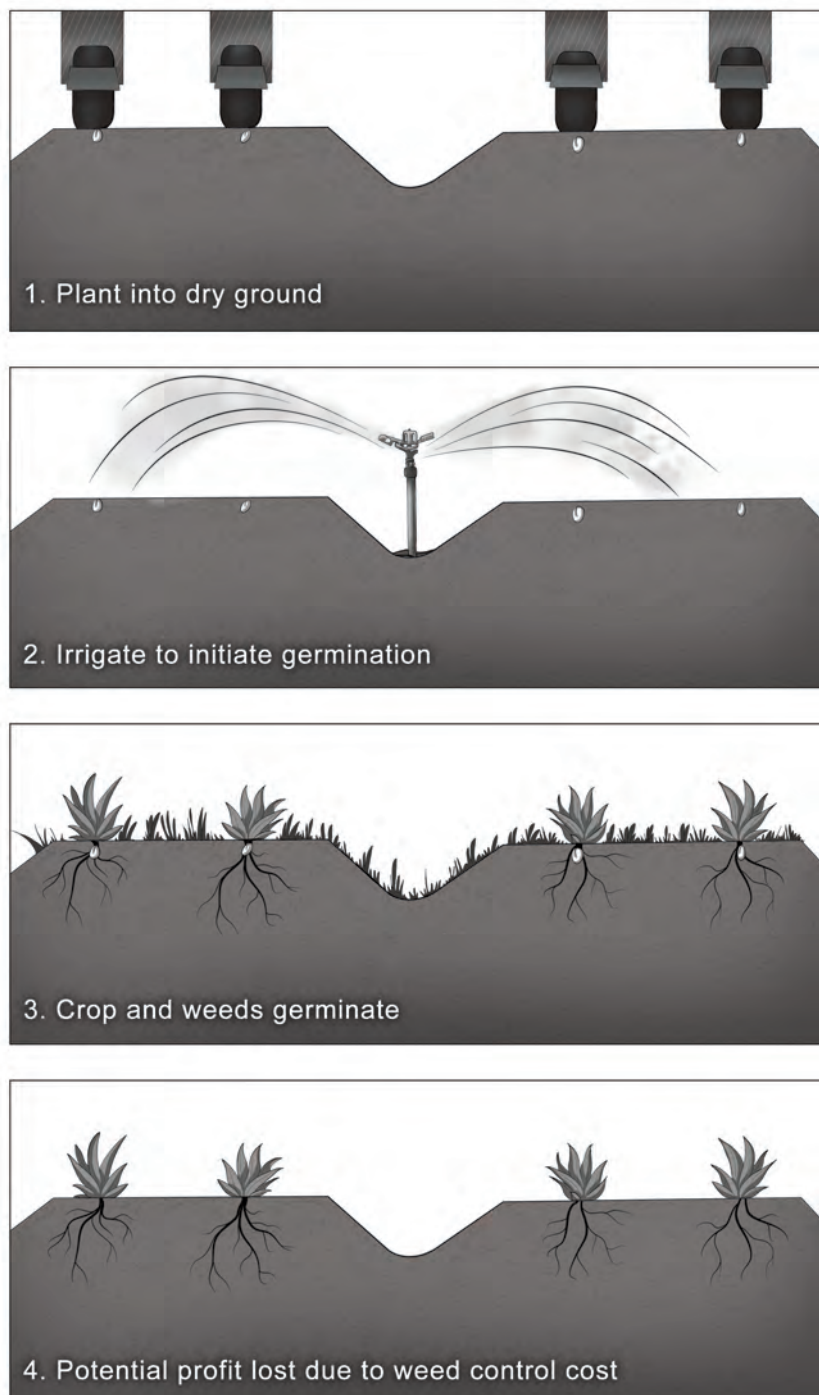

Illustration by José Miguel Mayo

Reading and Interpreting Soil Test Reports

Introduction	431
Lecture 1: Using a Soil Test to Assess Soil Quality	433
Lecture 2: Properties Measured in a Soil Analysis	437
Lecture 3: Applying Soil Amendments and Fertilizers	441
Demonstration 1: Taking a Soil Sample for Laboratory Analysis	
Instructor's Demonstration Outline	443
Students' Step by Step Instructions	447
Demonstration 2: Nitrogen Budgeting	
Instructor's Demonstration Outline	445
Demonstration 3: Field Observations	
Instructor's Demonstration Outline	447
Assessment Questions and Key	453
Resources	456
Supplement 1: Soil Contamination and Urban Agriculture	459
Appendices	
1. Sample Soil Analysis Reports	461
2. Example of a Nitrogen Budget	465
3. Nitrogen Budgeting Worksheet	466
4. Optimal Nutrient Levels of Major Cations Based on CEC	467
5. Nutrient Content of Common Fertilizers and Amendments	468
6. Approximate Pounds/Acre of Nutrients Removed by Common Crops	469

Introduction: Reading & Interpreting Soil Test Reports

UNIT OVERVIEW

Soil analyses can help form the basis of a sound soil fertility and plant nutrition program. In this unit, students will learn how to collect soil samples for laboratory analysis, and interpret and use soil analysis report data as a tool for soil quality assessment. Lectures and demonstrations will present the way that soil analysis results can be incorporated into an overall soil management plan.

Note: Before introducing the material in this unit, Part 2 of this manual on applied soil science (Units 2.1–2.3) should be presented to students who do not have a background in basic soil physical properties, chemistry, and biology. Unit 2.2, Soil Chemistry and Fertility, is an especially useful complement to the material presented here. In addition, Unit 1.1, Managing Soil Health, should be presented prior to this unit.

MODES OF INSTRUCTION

- > LECTURES (3 LECTURES, 2–2.5 HOURS TOTAL)
 - Lecture 1 covers the role of soil analysis in sustainable agriculture.
 - Lecture 2 addresses the soil properties measured in a comprehensive soil analysis.
 - Lecture 3 offers a short look at basic considerations in applications of soil amendments and fertilizers.
- > DEMONSTRATION 1: TAKING A REPRESENTATIVE SOIL SAMPLE (1.5 HOURS)
 - Demonstration 1 illustrates the basic procedures involved in taking a representative soil sample for laboratory analysis.
- > DEMONSTRATION 2: NITROGEN BUDGETING (1 HOUR)
 - Demonstration 2 offers an example of how a simple nitrogen budget can be calculated for an organic farm or garden.
- > DEMONSTRATION 3: FIELD OBSERVATIONS (1.5 HOURS)
 - Demonstration 3 provides an outline to use in visiting a farm or garden operation for which a soil report has been prepared. This outline directs students in how to observe the relationship between soil fertility management practices and plant nutrient levels (identified in the soil test) to plant growth and pest responses found in the field.
- > ASSESSMENT QUESTIONS (0.5 HOUR)
 - Assessment questions reinforce key unit concepts and skills.

LEARNING OBJECTIVES

CONCEPTS

- The role of soil analysis in providing current assessments of soil fertility/quality for crop growth
- The necessity of soil analysis in the formulation of accurate amendment recommendations for soil fertility and plant nutrition programs
- The importance of soil fertility in yields, crop health, crop quality, and the resistance and resilience of crop plants to pests and pathogens
- Fertilization trends in modern agriculture and the correlation with pest and disease susceptibility
- Factors involved in nitrogen budgeting and soil organic matter management

SKILLS

- How to access regional soils information
- How to take a representative soil sample
- How to read and interpret soil analysis report data
- How to develop an estimated nitrogen budget for your crop(s)
- How to relate observed crop problems to fertility programs

Lecture 1: Using a Soil Test to Assess Soil Quality

Pre-Assessment Questions

1. What is one of the drawbacks of relying on synthetic N-P-K fertilizers?
2. What negative consequences may result from excess nitrate nitrogen in the soil and in crops?
3. What role can a soil test play in developing a sound soil management plan?
4. Explain the difference between well-decomposed, stabilized compost and other sources of raw organic matter (e.g., cover crops, manure) in terms of its utility as a soil amendment or fertilizer
5. What are some of the key soil properties measured in a soil test?
6. Why is it important to ensure that soil pH is maintained in an optimal range?
7. How might one assure that adequate quantities of plant available nitrogen (N) are made accessible to crops without excessive fertilization?

A. Critical Terms in Soil Fertility Management

1. Amendment: An organic matter or mineral material applied to the soil to improve or maintain the physical, chemical, and/or biological properties of the soil. (Contrast to fertilizer, below.)
2. Fertilizer: A readily available and concentrated source of plant nutrients used to supply limiting nutrients to growing plants in order to prevent short-term nutrient deficiencies
3. A fertilizer can also be a feedstock for soil microbes, thus improving soil's physical, biological, and chemical properties. Fertilizers such as gypsum/lime can improve soil structure; conversely, salt concentrates in fertilizers, e.g., sodium nitrate, can adversely affect soil structure. In addition, amendments such as composts or cover crops also supply nutrients to plants.

B. The Role of Soil Analysis in Sustainable Agriculture: Reducing Fertilizer Use and Improving Soil Quality and Human and Environmental Health

1. Soil fertility, plant health, and the resistance and resilience of crop plants to pests and pathogens
 - a) Much like the importance of nutrition to the health of humans, an optimal balance of available plant nutrients will maintain desirable physical, chemical and biological properties of agricultural soils. Proper nutrition will also help prevent nutrient-related plant stress and crop losses through pests, diseases, and poor post-harvest quality.
2. Review of soil nutrients as potential limiting factors in plant growth (see also discussion in Unit 2.2, Soil Chemical Properties)
 - a) Leibig's Law of the Minimum: "Plant production can be no greater than the level allowed by the growth factor present in the least amount to the optimum amount for that factor"
 - i. Example: Barrel analogy with staves of varying lengths. The shortest stave (the limiting nutrient) will determine the total volume of water (yield) that can be held.
3. Fertilizer, fertilizer use, and soil testing trends in modern agriculture (see Unit 3.1, The Development of U.S. Agriculture)

- a) Leibig oversimplified: Subsequent reductionist interpretations of Leibig's Law have tended to focus research and development in soil fertility on defining sufficient levels of individual plant nutrients (see below) and the development of synthetic forms of nutrients in order to maximize crop yields while minimizing input costs. Such an approach to soil fertility management has led to the development and widespread use of synthetic N-P-K; however, overuse of these inputs often results in compromises in soil quality. This approach does not replace soil organic matter nor does it consider the optimal nutrient requirements needed to sustain the desirable physical, chemical, and biological properties of agricultural soils.
 - b) Increased reliance on synthetic N-P-K fertilizer in the U.S.: From 1930–1980 domestic synthetic nitrogen fertilizer use increased from 9 to 47 million metric tons/year (see Gliessman 1998; U.S. Geological Survey 1998). Trends show steady increase in use of synthetic fertilizers (1960–2011) after a decline in the late 1980s (see www.ers.usda.gov/data-products/fertilizer-use-and-price.aspx).
 - c) Coincident with the increased use of synthetic nitrogen fertilizers, the use of cover crops as fertilizers and soil amendments declined markedly on farm-scale operations
 - d) The use of soil testing in developing amendment and fertilizer plans: Many U.S. farmers have historically fertilized routinely using concentrated N-P-K fertilizers without determining the actual nutrient needs of the crops through soil analysis and nutrient budgeting. This has led in some instances to the overapplication of N-P-K fertilizers, while other limiting plant nutrients for soil chemical and physical properties have been overlooked. A 2006 study of field crops by the USDA's Economic Research Service found that only 35% of farmers employed all three recommended "best management practices" in applying nitrogen fertilizers (Ribaudo et al. 2011).
4. Excess fertilizer use, pest and disease susceptibility
- a) Over 60 studies have indicated that crops grown in soils with excess or deficient nutrients or poor soil physical properties yield less, are more susceptible to pests and pathogens, and produce crops with poor post-harvest quality (see Young 1999)
5. Excess fertilizer use and fertilizer pollution (see Unit 3.3, Environmental Issues in Modern Agriculture)
- a) Nitrate enters streams and lakes mainly via leaching and subsurface flow; some organic N and ammonium are also deposited via runoff and erosion. Runoff and erosion are also major route for phosphorus. These nutrients may pollute surface waters, leading to eutrophication and the degradation of aquatic ecosystems.
 - b) Excess nitrate may also leach into groundwater, increasing the incidence of nitrate poisoning of infants and children (see Supplement 4, Nitrate Contamination of Groundwater, in Unit 1.5, Irrigation–Principles and Practices). Subsurface flow down slopes is a major route for nitrate entering rivers and other waterways.
 - c) Is there greater efficiency or reduced nutrient runoff from "organic" farms? Without proper nutrient budgeting and efficient amending, excessive organic matter-based fertilizer inputs into "organic" farms may also contribute to nutrient runoff resulting in similar environmental problems. It is therefore critical that both short- and long-term nutrient budgets be established in order to assure a balance of nutrient inputs (amendments, fertilizers) with outputs (harvest) and crop demand, and avoid excessive fertilization.

6. Summary: Soil nutrient deficiencies decrease soil quality and increase the risks of plant stress, poor yields, and susceptibility of crop plants to both pests and pathogens. Equally so, the overuse of synthetic or organic matter-based fertilizers may increase disease and pests incidences, reduce crop quality, and lead to environmental pollution and human health risks due to dietary exposure to nitrate. Without the replacement of soil organic matter, synthetic fertilizers pose the additional risks of soil degradation and eventual yield decreases. Soil analysis is therefore the foundation of a rational and efficient use of soil amendments and fertilizers that may help develop productive agricultural soil and at the same time avoid the problems associated with the overuse of fertilizers.

C. Soil Testing as a Soil Fertility Management Tool

1. A soil test provides current quantitative information on the nutrient content and the nutrient-supplying capacity of a soil. This includes measures of % base saturation, which indicates the ratio of base ions held on the exchange sites; a quantitative measurement of the cation exchange capacity (CEC), a measurement of the soil's potential to hold and exchange cation nutrients; and parts per million (ppm) of nutrients such as N, P, K, Mg, etc.
2. Soil analyses can provide an accurate determination of a soil's textural classification, which may help a grower anticipate how a soil will respond to cultivation as well as the soil's nutrient- and water-holding capacity
3. A soil analysis provides quantitative data allowing for the comparison of a given soil's nutrient and chemical profile with established benchmarks for each property. This helps to identify nutrient levels (or soil chemical properties such as pH) that are above or below optimal benchmarks. This may be remedied over the long term with annual soil amending.
4. Soil analysis also helps to identify nutrients that exist at very low (limiting nutrients) or very high (potentially toxic) levels that may result in acute plant nutrient deficiencies or toxicity. Once identified, these soil nutrient imbalances may be addressed through amending and/or a supplemental fertilizing program.
5. Soil testing provides essential information (e.g., estimated nitrogen release) that may be used in developing efficient nutrient budgets for your crops (see nitrogen budgeting, below)
6. Soil testing allows for periodic monitoring of soil chemical properties in order to maintain the soil nutrient levels (and chemical properties such as pH) within the established optimal ranges and may serve as an accurate indicator of nutrient depletion or accumulation
7. Specialized testing may be used for specific soil nutrients of concern, to test the nutrient content of composts, as well as to determine the presence of pesticides, heavy metals, or other potentially toxic compounds in a soil. See Resources section for testing services.
8. Summary: Soil analysis is the foundation of a rational and efficient use of soil amendments and fertilizers. When properly applied, these inputs—along with other sound agricultural practices—will help develop productive agricultural soil and avoid the environmental and pest management problems associated with nutrient deficiencies and the overuse of fertilizers.

How Does Parts Per Million (ppm) Relate to Pounds Per Acre?

One acre of soil to a 6-inch depth weighs approximately 2 million pounds. One ppm in 2 million pounds is 2 pounds. To convert ppm to pounds per acre, multiply by two. To convert pounds per acre to ppm, divide by 2.

D. Soil Testing and Recommendation Philosophies

1. Sufficient Levels of Available Nutrients (SLAN): The SLAN approach states that there are definable levels of individual nutrients in the soil below which crops will respond to fertilizers, and above which they likely will not respond through changes in measurable yield or reduction of deficiency symptoms. Building levels of soil nutrients above the point at which a yield increase is observed is considered inefficient.

2. Cation Saturation Ratio (CSR; also known as % base saturation): The CSR approach states that there are optimal ratios and amounts of certain cation soil nutrients (e.g., calcium, magnesium, potassium, and sodium) that when present in agricultural soils lead to greater soil quality (physical, chemical, and biological properties), crop and animal health, an increased resistance to pests and pathogens (pre- and post harvest), and increased crop productivity. The % base saturation reflects the % of exchange sites on soil particles that are “held” by the basic cations (Ca^{++} , Mg^{++} , K^+ , and Na^+); the remainder of sites are held by acidic cations (H^+ , Al^{+++}).
3. Nutrient Build-Up and Maintenance: This approach calls for initial application(s) of given deficient nutrients in quantities that will raise the soil level of those nutrients to the point where crop yields are maximized. This is followed by annual amendment applications that will maintain a non-limiting soil nutrient level. It is often suggested that such build-up be done over a 2- to 4-year period. This approach emphasizes the major nutrients (nitrogen, phosphorus, and potassium) and does not focus equally on all 13 essential plant nutrients.
4. Most testing services have established optimal ratios for general soil fertility that are a combination of SLAN, CSR, and Nutrient Build-Up and Maintenance approaches. As different testing services use different extraction techniques, it is important to consult with your local testing service on the system they use in developing amendment recommendations. Always request “best practices” benchmarks for maintaining soil quality if different than above. Specify the crop or crops being grown, and let the lab know that you are using organic techniques. Request “recommendations” when submitting a soil sample for analysis.
5. If possible, use a regional soil testing lab, which will be familiar with your local soil conditions

Note that different soils can require different nutrient extraction techniques, e.g., some are developed for soils with a given pH range and will give misleading results for soils outside of that range. Also, the presence of high levels of certain compounds in the soil may distort soil tests and require different extraction techniques.

The specific nutrient levels listed in this unit are based on the extraction techniques used at specific laboratories. Although over 90% of U.S. agricultural testing services use the same extraction techniques, some variation exists.

Note: It is **critical** that one confirms the specific “optimal” levels used in this unit with those used by your local testing service. The optimal levels presented in this unit are examples of those used by many A & L National Agricultural Laboratories.

Lecture 2: Properties Measured in a Soil Analysis, Lab Recommendations, & Interpretations

See also Unit 2.2, Soil Chemistry and Fertility

A. Review of the Soil Properties Measured in a Comprehensive Soil Analysis

(see Appendix 1, Sample Soil Analysis Reports)

1. Percent (%) Organic Matter

- a) Defined: The measurement of the percent organic matter content of a soil. Includes raw and soil organic matter. Not a measure of the quality of organic matter.
- b) Desirable range for percent organic matter: As climate influences the ability of organic matter to accumulate, no benchmarks for soil organic matter (SOM) can be broadly applied. A soil organic matter higher than 2%, and ideally 3–5% organic matter content in cool temperate climates is desirable.
- c) Measuring changes in SOM over time is useful in monitoring impacts of a soil management program

2. Estimated Nitrogen Release (ENR)

- a) ENR defined: The amount of plant available nitrogen in lbs/acre estimated to be released through the mineralization (by microbial action) of the currently existing soil organic matter during a single growing season
- b) The accuracy of ENR figures: The amount of nitrogen liberated from the decomposition of organic matter is dependent upon soil biological activity. This activity is influenced by soil and environmental conditions such as soil temperature and other climatic conditions; soil pH; the chemical composition of the organic matter (e.g., soils amended with materials high in carbon will release nitrogen slowly, vs. cover crops that can release N quickly following incorporation); soil aeration; and soil moisture, among others. Therefore, the ENR figure listed in the soil analysis report is strictly an estimate.
- c) How to use ENR figures: ENR data are one set of figures (added to the nitrogen contributions of compost and cover crops) that are used in calculating a nitrogen budget for your crop(s). (See Appendix 2, Example of a Nitrogen Budget and Appendix 3, Nitrogen Budgeting Worksheet.)
 - i. ENR and annual crops: Use 60% of the ENR figure listed on the soil test for annual crop production
 - ii. ENR and perennial crops: Use 80% of the ENR figure listed on the soil test for perennial crop production

3. Extractable phosphorus (P): Two types of tests are commonly used to illustrate the phosphorus availability at different pH levels

- a) Available phosphorus (P1) Weak Bray method for acidic soils (pH below 6.2)
 - i. Optimal levels of more readily available phosphorus (P1): 30–40 ppm
- b) Olsen sodium bicarbonate extraction for basic soils (pH above 7.5); this is the appropriate test for most California agricultural soils
 - i. Optimal levels of phosphorus: 40–60 ppm at pH of 6.0 or higher for cool season vegetable crops, or 15–25 ppm for warm season vegetable crops
- c) Note that cool season crops may require P supplementation, as cold soil temperatures reduce biological activity and thus the availability of P to plants

4. Extractable potassium/potash (K): The amount of exchangeable K in ppm found in a given soil sample
 - a) Optimal levels of available K
 - i. The optimal level of K in a given soil is 2–5% of the base saturation
 - ii. Total amount (in ppm) to achieve this is based on the CEC of the soil
 - iii. Optimal levels for coarse-textured soils range from 150–175 ppm; for heavy-textured soils, 175–250 ppm
5. Extractable magnesium (Mg): The amount of exchangeable Mg in ppm found in a given soil sample
 - a) Optimal levels of available Mg
 - i. The total amount (in ppm) to achieve this is based on the CEC of the soil
 - ii. Optimal range of Mg: 100–250 ppm
 - iii. The optimal level of Mg in a given soil is 10–20% of the base saturation. Soils with Mg levels over 23% of base saturation often exhibit drainage problems and require attention.
6. Extractable calcium (Ca): The amount of exchangeable calcium in ppm found in a given soil sample
 - a) Optimal levels of available Ca
 - i. The optimal level of Ca in a given soil is 65–75% of the base saturation
 - ii. The total amount (in ppm) to achieve this is based on the CEC of the soil
7. Sodium (Na): The amount of exchangeable sodium in ppm found in a given soil sample
 - a) Optimal levels of available Na
 - i. The optimal level of Na in a given soil is 0–5% of the base saturation. The total amount (in ppm) to achieve this is based on the CEC of the soil, but in general should be below 100 ppm. Sodium levels exceeding 5% of base saturation can cause serious soil structure issues that will affect water movement, aggregation, and tilth.
8. pH: The measurement of the acidity or alkalinity of a given soil (determined by the concentration of hydrogen ions)
 - a) Example: A pH of 7.0 is neutral (e.g., pure water). Low pH is acid (e.g., lemon juice or vinegar pH ~4.0). A high pH is referred to as basic or alkaline (e.g., lye pH ~9.0).
 - b) Optimal pH range: 6.3–6.8 for a mineral soil; 5.5–6.0 for an organic soil (see Unit 2.2, Soil Chemistry and Fertility)
 - c) Typically the most important soil lab recommendations are related to soil pH adjustment and the addition of liming materials, as proper soil pH is critical to plant nutrient availability. It is important to follow the soil lab recommendations for adjusting pH; there are many factors to be taken into account, including soil type, CEC, the buffering capacity of the soil, and macro and micro nutrient levels. It is often worth a call to the lab for clarification on amendment material composition and particle size, as the types of organically allowed materials are often limited. Materials applied to adjust pH include:
 - i. CaCO_3 – calcium carbonate – calcitic limestone: added to acidic soils to increase pH
 - ii. $\text{CaMg}(\text{CO}_3)_2$ – calcium/magnesium carbonate – dolomitic lime: added to acidic soils to increase pH when Mg is deficient
 - iii. $\text{CaSO}_4 + 2\text{H}_2\text{O}$ – calcium sulfate – gypsum: added to alkaline soils to decrease pH when Ca is deficient
 - iv. S – elemental sulfur: added to alkaline soils to decrease pH when Ca is adequate

9. Buffer index: An index based on the soil pH that is used to estimate the amount of agricultural lime needed to raise a soil with a pH of 6.5 or less to several higher pH levels (6.0 and 6.5)
10. Hydrogen: A measurement of the hydrogen ion concentration in meq/100g of soil in a given soil sample. As the hydrogen ion concentration increases, soil acidity will correspondingly increase, represented by a decrease in pH.
11. Cation Exchange Capacity (CEC): A measurement of the soil's ability to hold and exchange cation nutrients (e.g., Ca, Mg, Na, K, hydrogen) with growing plants. The sum of the exchangeable cations. The CEC of a soil is influenced by the amount and types of clays and organic matter in the soils; soils with higher clay and organic matter content usually have higher CECs, and are therefore the most fertile (see Unit 2.2 for more on CEC).
12. Base saturation: The relative percentages of the major cation nutrients found occupying cation exchange sites in a given soil. (Balances recommended by most agronomists are given below. Totals of these percentages should add up to 100.)
 - a) % Potassium (K): 2–5%
 - b) % Magnesium (Mg): 10–15%
 - c) % Calcium (Ca): 65–75%
 - d) % Hydrogen (H): 0–20%
 - e) % Sodium (Na): 0–5%
13. Nitrate nitrogen (NO_3^-): The amount of water-soluble nitrogen (nitrate) in ppm found in a given soil sample. Nitrate (along with ammonium, NH_4^+) is a plant-available form of nitrogen resulting from nitrogen fixation and mineralization actions of soil microbes.
 - a) Note that the test for NO_3^- is not reliable for determining the need for nitrogen inputs in organic farming systems because it doesn't reflect "non-mineralized" N available from SOM. Although the test provides a "snapshot" of NO_3^- level at the time of sampling, it can't measure future availability of NO_3^- .
14. Sulfate (SO_4^-) sulfur (S): The total amount of sulfur in ppm found in a given soil sample
 - a) Optimal levels of available S: 25–35 ppm
 - b) A shortage of either S or N will limit the availability of the other
15. Micronutrients/trace elements
 - a) Zinc (Zn): The extractable amount of zinc (in ppm) found in a given soil sample
 - i. Optimal levels of available Zn: 1.1–3.0 ppm (DTPA extraction)
 - b) Manganese (Mn): The extractable amount of Mn (in ppm) found in a given soil sample
 - i. Optimal levels of available Mn: 9–12 ppm (DTPA extraction)
 - c) Iron (Fe): The extractable amount of Fe (in ppm) found in a given soil sample
 - i. Optimal levels of available Fe: 11–16 ppm (DTPA extraction)
 - d) Copper (Cu): The extractable amount of Cu (in ppm) found in a given soil sample
 - i. Optimal levels of available Cu: 0.9–1.2 ppm (DTPA extraction)
 - e) Boron (B): The extractable amount of B (in ppm) found in a given soil sample
 - i. Optimal levels of available B: 0.6–1.2 ppm (hot water extraction)
 - f) Plant tissue testing is the most accurate way to gauge adequate micronutrient levels. See *A & L Agronomy Handbook* in Resources section.
16. Excess lime: A visual observation and rating of carbonates in a soil sample. High levels of free lime present may interfere with nutrient availability.
17. Soluble salts: Total measurement of soluble salts by electrical conductivity (ECE). High levels indicate higher risk of plant toxicity due to salt accumulation from fertilizers, poor irrigation water, or chemical contamination.
 - a) Optimal levels of available soluble salts: Less than 2.0 mmhos/cm or <100 ppm

18. Chloride

- a) Present in small amount in practically all soils. In farming systems, chloride may be supplied by irrigation water and organic sources such as manure and compost. Soil testing for chloride is not a common practice.

B. Additional Lab Tests

1. Qualitative tests: Critical for assessing sustainable soil management practices over time; see more at: soilquality.org/indicators.html
 - a) Aggregate stability: Indicator of soil organic matter and biological activity
 - b) Available water capacity: Maximum amount of plant available water a soil can provide; indicates a soil's ability to hold water and make it available for plant use
 - c) Field penetration resistance: A measure of soil compaction, measured in pounds per square inch (psi) using a tool that measures a soil's resistance to penetration
 - d) Active carbon: A measure of soil organic matter that is readily available as a carbon and energy source for the soil microbial community, and a leading indicator of soil health response to changes in crop and soil management (see *Cornell Soil Health Assessment Training Manual* in Resources)
 - e) Bulk density: Indicator of soil compaction, typically expressed as g/cm^3
2. Other plant, soil, and water tests
 - a) Plant tissue analysis: Often used in conventional systems to provide guidelines for "quick fixes" of nutrient imbalances
 - b) Soil texture/physical properties: The relative proportions (percentage) of sand, silt, and clay particles measured in the soil analysis
 - c) Water analysis: Can be used to determine potential source of excess salt, boron, or sodium showing up on soil analysis
 - d) Soil microbial community assessment (fungal/bacterial ratio): No current consensus about the utility of these types of tests
 - e) Organic fertilizer/compost: Useful information for determining fertility management strategies that ensure proper nutrient balance
 - f) Pathology: Most soil and airborne plant pathogens can only be accurately diagnosed through lab analysis

Lecture 3: Applying Soil Amendments & Fertilizers

A. Applying Soil Amendments and Fertilizers (see www.groworganic.com for more information, materials and equipment for amending and fertilizing)

1. Soil Amendments

- a) Timing of amending: Early fall is a preferred time for soil amending with mineral amendments as it allows for several months of winter to elapse during which mineral amendments break down, making the nutrients more available in the spring. Note, however, that soluble nitrogen is easily leached during winter rains.
- b) Quantities to apply in a given year: Total quantities of amendments to be applied will depend on the levels of soil nutrients reported in a soil analysis report and determined necessary through nutrient budgeting. If soil tests indicate the need for large quantities of amendments, growers should follow the manufacturers' and agronomists' recommendations for application rates, as the potential toxicity of different soil amendments to the soil and crops is highly variable.
 - i. Example: Agricultural gypsum with a low potential toxicity may be applied when indicated by a soil test to the soil at an annual rate of 2+ tons/acre, whereas most micro-/trace elements have a high potential toxicity and should be applied sparingly, often at 0.5–2 gallons/acre
- c) Depth of incorporation of soil amendments: Soil amendments should be evenly incorporated into the depth of tillage, or banded down rows in the case of acute nutrient deficiencies. Leachable nutrients should be applied at and above the effective feeding root zone of crops being grown. Amendments such as P, which do not readily move downward in the soil profile, should be banded at the root depth of the crop.
- d) Tools and techniques used for incorporating soil amendments: Soil amendments may best be incorporated with cover crops seed in the fall using similar equipment

B. Supplemental Fertilizing

- a) Timing of fertilizing: The timing of supplemental fertilizing is determined by need based on plant tissue testing and/or growth response observations
- b) Quantities to apply in a given year: The concentration of nutrients varies in various supplemental fertilizers; follow the manufacturer's and agronomists' recommendations for application rates
- c) Application of supplemental fertilizers
 - i. Foliar application: Foliar fertilizers are sprayed directly on the growing plants and are absorbed through the stomata. Foliar fertilizers should be applied during cool parts of the day (when the greatest number of stomata are most open) and to the underside of the leaves (where the greatest concentration of stomata are located).
 - ii. Soil-based application: Supplemental fertilizers may be injected into the irrigation system (requires filtration) or applied directly to the soil surface around the root systems of the crops. If applied directly to the soil surface it is generally recommended to apply the fertilizer prior to irrigation.
- d) Tools used for incorporating fertilizers
 - i. Spray rigs or backpack sprayers may be used on a field and garden scale to apply mist and liquid fertilizers
 - ii. Fertigation (injecting fertilizer through irrigation equipment): See equipment suppliers for specialized equipment and formulations
 - iii. Others

Demonstration 1: Taking a Soil Sample for Laboratory Analysis

for the instructor

OVERVIEW

Collecting a representative sample of a given soil is critical to receiving accurate soil analysis information. In this demonstration, the instructor should discuss the sampling considerations given in the Demonstration Outline, and demonstrate the tools and techniques used to take soil samples and prepare a suitable sub-sample for laboratory analysis.

RESOURCES AND REFERENCES

- *Agronomy Handbook: Soil and Plant Analysis*. A & L Western Agricultural Laboratories, Inc. Ordering information: www.allabs.com/publications/agronomy_handbook2.aspx
- Magdoff, Fred and Harold Van Es. 2010. *Building Soils for Better Crops, Third Edition*. Handbook Series Book 4, Sustainable Agriculture Network. Ch. 21: Getting The Most from Routine Soil Tests. Free download available at: www.sare.org/Learning-Center/Books/Building-Soils-for-Better-Crops-3rd-Edition

PREPARATION AND MATERIALS

- Stainless steel or chrome soil auger or stainless steel trowel
- Plastic buckets
- Sample bags from laboratory
- County soil survey maps
- Laboratory forms for submitting sample and request for analysis
- Notebook, pen, and folder for documenting
- Student preparatory reading: *A & L Reference Guide—“Sampling Soil”*

PREPARATION TIME

1.5 hours

DEMONSTRATION TIME

1.5 hours

DEMONSTRATION OUTLINE

A. Sampling Procedures

1. Sample area
 - a) First discuss the use of County soil maps to help delineate regional variations in soil textural classifications
 - b) Different soil types (texture and color), distinct crop growth response areas, or soil treatment areas are sampled separately
 - c) Each sample should be from a plot no larger than 40 acres
 - d) Avoid: Corners of fields, poorly drained areas, and 50 feet from structures and roads
 - e) Problem areas: Sample “problem” areas (e.g., poor drainage, poor plant growth responses) and “good” areas for comparison; include surface and subsoil sample for problem areas
 - f) Varying terrain: Sample bottom land and hills separately
2. Time of year to sample
 - a) Samples may be taken at any time (though fall is often recommended)
 - b) Be consistent from year to year with sampling time and testing service
 - c) Combining soil samples and plant tissue samples with plant growth observations
 - d) Frequency
 - i. Initial stages of soil development and intensive cropping systems: 1x/year
 - ii. Once chemical benchmarks have been reached: 1x/2-3 years
3. Demonstrate tools used in sampling
 - a) Stainless steel soil auger, steel trowel, or spade/shovel
 - b) Plastic buckets
 - c) Sample bags from lab
4. Demonstrate sampling depth (should be consistent from year to year)
 - a) Initial sampling
 - i. Remove plant residues from surface (do not include this or other distinguishable forms of organic matter in sample)
 - ii. Sample distinct soil horizons separately (e.g., A and B horizons), if within the depth tillage, noting depth to each horizon
 - b) Subsequent sampling
 - i. Remove plant residues from surface (do not include in sample)
 - ii. Sample to 12 inches or depth of tillage unless problem soil (see below)
 - iii. Include entire soil profile from auger core or soil slice
 - c) “Problem” soils
 - i. Include separate surface and sub-soil sample (inquire with testing service)
 - d) Orchard systems
 - i. Pre-plant depth: Sample to depth of tillage
 - ii. In established no-till orchards: Sample to 6 inches in depth
5. Demonstrate sample size
 - a) 2 cups of soil sub-sampled from well-mixed composite of 10–20 random samples, including for textural classification
 - b) 2 cups each for nematodes, pesticide residues, or other specialized sampling

6. Demonstrate sample preparation
 - a) Mix cores or slices together
 - b) Fill sample bag provided with sub-sample (no need for further processing)
7. Completing lab forms and personal documenting
 - a) Location of sample/field
 - b) Date
 - c) Previously grown crops and/or crops to be grown
 - d) Sample depth
 - e) Specific type of analysis to request
 - i. Initial soil analysis
 - ii. Problem soils/troubleshooting
 - f) Plant growth responses
8. Specialized sampling (separate test for each)
 - a) Pesticides (inquire with testing service)
 - b) Nematodes (inquire with testing service)
 - c) Problem soils (inquire with testing service)
 - d) Compost analysis (inquire with testing service regarding organic amendment sampling)

Demonstration 1: Taking a Representative Soil Sample for Laboratory Analysis

step-by-step instructions for students

INTRODUCTION

The key to receiving accurate soil analyses information is to properly collect and submit a representative sub-sample of a given soil. Follow the steps outlined in these instructions when taking a soil sample for laboratory analysis.

PREPARATION AND MATERIALS

- Stainless steel or chrome plated soil auger or stainless steel trowel
- Plastic buckets
- Sample bags from soil testing laboratory
- County soil survey maps

RESOURCES AND REFERENCES

- For a review of plant analysis techniques see: Agronomy Handbook: Soil and Plant Analysis. Ordering information: www.allabs.com/publications/agronomy_handbook2.aspx
- Illustrated soil sampling techniques: www.al-labs-west.com/sections/anservice/sampling
- Magdoff, Fred, and Harold Van Es. 2010. Building Soils for Better Crops, Third Edition. Chapter 21, Getting the Most from Routine Soil Tests. Free download available at: www.sare.org/Learning-Center/Books/Building-Soils-for-Better-Crops-3rd-Edition

STUDENT OUTLINE

A. Sampling Procedures

1. Sample area
 - a) County soil maps may help delineate regional variations in soil textural classifications and land uses for that soil type
 - b) Different soil types, including texture, color, distinct crop growth response areas and/or soil treatment areas should be sampled separately
 - c) Sample from areas of 40 acres or less
 - d) Avoid: Corners of fields, poorly drained areas and 50 feet from structures and roads
 - e) Problem areas: Sample “problem” areas (e.g., poor drainage or poor plant growth responses) and “good” areas for comparison; include surface and subsoil sample
 - f) Varying terrain: Sample bottom land and hills separately
2. Time of year to sample
 - a) Samples may be taken at any time (though fall is often recommended)
 - b) Be consistent from year to year with sampling time, locations, and testing service
3. Frequency of sampling
 - a) Initial stages of soil development and intensive cropping systems: 1x/year
 - b) Once chemical benchmarks have been reached: 1x/2–3 years

4. Tools to use when taking soil samples
 - a) Stainless steel soil auger, stainless steel trowel or stainless spade/shovel
 - b) 5-gallon plastic buckets (to hold 15–30 cups of soil total)
 - c) Sample bags from testing agency
5. Sampling depth (should be consistent from year to year)
 - a) Initial sampling
 - i. Remove plant residues from surface (do not include in sample)
 - ii. Sample distinct soil horizons separately (e.g. , A and B horizons), if within the depth of tillage, noting depth to each horizon
 - b) Subsequent sampling
 - i. Remove plant residues from surface (do not include in sample)
 - ii. Sample to 12 inches unless problem soil (see below)
 - iii. Include entire soil profile from auger core or soil slice
 - c) Problem soils
 - i. Include separate surface and sub-soil sample (inquire with testing service)
 - d) Orchard systems
 - i. Pre-plant depth: Sample to depth of tillage
 - ii. In established no-till orchards: Sample to 6 inches in depth
6. Sample size
 - a) 2 cups of soil sub-sampled from well-mixed composite of 10–20 random samples, including for textural classification
 - b) 2 cups each for nematodes, pesticide residues, or other specialized sampling
7. Sample preparation
 - a) Mix cores or slices together from 10–20 random samples
 - b) Fill sample bag provided with 1.5 cups of soil sub-sampled from well mixed composite
 - c) No need for further processing
 - d) For problem soils, submit soil sample with a plant tissue sample and description of plant growth observations when trouble shooting poor crop growth responses (see sample depth, above)
8. Completing lab forms and personal documenting
 - a) Location of sample/field
 - b) Date
 - c) Crop previously grown and/or those to be grown
 - d) Sample depth
 - e) Specific type of analysis requested (inquire with testing service)
 - f) Observations of plant growth responses, if problems
9. Specialized sampling
 - a) Pesticides (inquire with testing service for specific sampling procedures and sample volumes)
 - b) Nematodes (inquire with testing service)
 - c) Problem soils (inquire with testing service)
 - d) Compost analysis (inquire with testing service about organic matter amendment sampling)

Demonstration 2: Nitrogen Budgeting

for the instructor

OVERVIEW

This demonstration offers an example of how a simple nitrogen budget can be calculated for an organic farm or garden. Using the nitrogen budgeting worksheets and the Demonstration Outline below, discuss and demonstrate the process of calculating an estimated nitrogen budget for a farm, factoring estimated nitrogen release (ENR) from compost, cover crops, and existing soil organic matter. For this exercise, Appendix 2 (Nitrogen Budgeting Exercise) includes an example of the steps involved in calculating a basic nitrogen budget.

PREPARATION AND MATERIALS

- Appendix 2, Example of a Nitrogen Budget
- Appendix 6, Approximate Pounds/Acre of Nutrients Removed by Common Crops
- Sample soil test report

PREPARATION TIME

0.5 hour

DEMONSTRATION TIME

1 hour

DEMONSTRATION OUTLINE

- A. Discuss rationale and goals of nitrogen budgeting**
 1. Meeting but not exceeding crop nitrogen requirements of crops
- B. Discuss factors to consider in N-budgeting for organic farming and gardening systems**
 1. Crop removal estimates and nutrient contributions of inputs (cover crops, compost, and ENR from SOM)
- C. Demonstrate how to use the crop removal estimates in Appendix 6 to provide an approximation of the amount of plant nutrients that are removed from the soil in a year by a specific crop or crops**
 1. This figure is placed on Line 1 of the Nitrogen Budgeting Worksheet (Appendix 3)
- D. Discuss nitrogen contributions from three major sources in organic farming systems: ENR from SOM, compost, and cover crops**
 1. Demonstrate how to transcribe the estimated nitrogen release (ENR) figures from the soil test to the Nitrogen Budgeting Worksheet for calculating the nitrogen contribution of ENR (see Line 2 of the Nitrogen Budgeting Worksheet)
 - a) Discuss the use of estimated nitrogen release in an annual and perennial cropping system
 - b) Demonstrate calculations

2. Demonstrate how to factor in the nitrogen contribution of compost using Line 3 of the Nitrogen Budgeting Worksheet
 - a) Discuss application rate
 - b) Discuss nitrogen content derived from analysis, and that nitrogen content is based on dry weight
 - c) Discuss wet weight of compost and how to calculate dry weight
 - d) Demonstrate multiplying dry weight by %N
 - e) Discuss and demonstrate %N available
3. Demonstrate how to determine the nitrogen contribution of nitrogen-fixing cover crops (see www.sarep.ucdavis.edu/ and Unit 1.6, Selecting and Using Cover Crops, for more information). These data should be included in Line 4 of the Nitrogen Budgeting Worksheet.
 - a) Demonstrate calculations
4. Discuss factoring in the nitrogen concentration in irrigation water
5. Discuss the accuracy of this type of nitrogen budgeting (see F, below)

E. Demonstrate how to calculate the balance of nitrogen inputs and outputs

1. Demonstrate totaling the nitrogen inputs by adding Lines 2–4 of the Nitrogen Budgeting Worksheet. This figure should be placed on Line 5 of the Nitrogen Budgeting Worksheet.
2. Demonstrate how the nitrogen contributions of all inputs should be subtracted from the crop removal estimates to determine the need for additional nitrogen inputs (e.g., increased application of compost, increased seeding rate of nitrogen-fixing cover crops, or supplemental fertilizing). This figure should be placed on Line 6 of the Nitrogen Budgeting Worksheet.

F. The challenges of accurate nitrogen budgeting in organic farming systems:

Factors influencing the release of nitrogen from organic matter

1. 99% of the N in most soil is tied up in soil organic matter (SOM), the release of which is dependent on soil conditions such as temperature, aeration, and moisture, which are in turn dependent on weather/air temperature, tillage, rainfall, and irrigation practices
2. The quality and quantity of existing soil organic matter and organic matter inputs. The C:N ratio, the presence of lignins and tannins, soil biological activity, and the placement of organic matter amendments in the soil profile all influence the mineralization rate of organic matter. The accuracy of the mineralization rates listed in the Nitrogen Budgeting Worksheet must be understood in this light and represent only a rough estimate.
3. Discuss long-term budgeting and nutrient management. The use of this nitrogen budgeting exercise, combined with annual soil analysis report data, can give a grower an indication of either the accumulation or depletion of soil nutrients. With such information, the grower may make adjustments to the system in order to balance nutrient inputs with outputs, thereby both assuring nutrient availability and avoiding the problems associated with excess soil nutrients.

Demonstration 3: Field Visit to a Working Agricultural Operation—Relating Crop Growth Observations to Fertility Programs

for the instructor

OVERVIEW

Visit a local garden or farm for which a soil analysis report has been prepared and reviewed by the class. Request from the grower an overview of the current soil fertility and pest and disease management plans and practices used in the operation. The overview should include the following components: soil textural classification; hydrology of fields; history of cultivation; history of soil testing and amending; the use of cover crops, compost, and crop rotation; the use of supplemental fertilization; primary tillage practices used; any persistent pest, disease, plant growth response and/or crop quality concerns occurring in the production of the crop(s).

Following the presentation, tour the fields/gardens looking for any nutrient deficiency symptoms that may be correlated with known physical or chemical properties of the soil (refer to soil analysis), and that may be associated with specific cultural practices. With the permission of the grower, samples of crop vegetation can also be taken for later comparison with photographs of crops with known nutrient deficiencies.

PREPARATION AND MATERIALS

- Sample lab analyses report
- Crop deficiency and toxicity reference charts (see below)

RESOURCES AND REFERENCES

- *Agronomy Handbook: Soil and Plant Analysis*. A & L Western Agricultural Laboratories, Inc. 1311 Woodland Ave., #1. Modesto, California 95351. (209) 529-4736. (For crop deficiency symptoms see pp. 87-92.)
- Unit 2.2 of this manual, Soil Chemistry and Fertility. (For crop deficiency symptoms see Lecture 2, Plant Nutrient Requirements and Nutrient Cycles; for websites containing photographs of specific crops with specific nutrient deficiencies see Resources section.)

DEMONSTRATION OUTLINE

A. Soil Fertility and Pest and Disease Management Plans and Practices: Grower Overview

1. Soil textural classification
2. Soil quality/soil tilth
3. Hydrology of fields
4. History of cultivation
5. History of soil testing, amending, and plant growth responses
6. The use of cover crops: Timing, application rate, and type
7. The use of composts: Timing, application rate, and type
8. The use of crop rotation: Timing and type
9. How they budget for nitrogen
10. The use of plant tissue testing: Timing and type
11. The use of supplemental fertilization: Timing, application rate, and type
12. Primary tillage practices used
13. Irrigation practices
14. Any persistent and economically significant problems
 - a) Pests
 - b) Diseases
 - c) Plant growth responses
 - d) Crop quality concerns

B. Field Observations

1. Deficiencies: Are there major or micronutrient deficiencies evident from the soil analysis? Are they also evident in the field?
2. Excesses: Are there major or micronutrient imbalances evident from the soil analysis (including those that cause poor soil physical conditions or toxicity such as...)? Are they also evident in the field?
3. Soil physical condition: How is the tilth of the soil? Is it cloddy or cracked, does it take tillage to achieve loose soil? Is there a compacted plow or disc pan 6 to 12 inches below the surface? Is the soil well aggregated?
4. Organic matter: Is there evidence of raw OM, an active humus layer, healthy bioactivity?
5. Crop health: Do the plants look healthy and deep green? Do they appear to be overfertilized with nitrogen?
6. Pests and disease: Is there evidence of pests, diseases, or damage from either? Does it appear that the plants are resilient to the damage, or do the crops appear stressed?
7. Water relations: Does the soil appear to have standing water, does it drain well, or have poor water retention? Does the soil stick to shoes when you walk through it? Are farm operations ever performed when it is wet?

Assessment Questions

1. What are the effects of excess nitrogen on crops and in the environment?
2. Give examples of raw organic matter.
3. Explain the difference between compost and other sources of organic matter.
4. Which nutrients affect pest and disease susceptibility?
5. In general, what is the minimum fertility program for sustainable production?

Assessment Questions Key

1. What are the effects of excess nitrogen on crops and in the environment?

Elongated cells with thinner cell walls, excess growth and vigor, increased susceptibility to pests and diseases, poor storage quality. Excess nitrogen released into the environment may lead to the eutrophication of aquatic ecosystems and the contamination of ground water.

2. Give examples of raw organic matter.

Leaves and leaf litter, crop stubble, manures, sawdust, plant and animal remains, cover crops and other undigested/undecomposed organic matter

3. Explain the difference between compost and other sources of organic matter.

Compost is aerobically decomposed organic matter; most other sources are raw organic materials that require digestion in the soil medium. Raw organic matter may take 3–6 weeks+ to break down and release nutrients, resulting in the temporary depression of soil nitrogen levels and the possibility of plant nitrogen deficiencies.

4. Which nutrients affect pest and disease susceptibility?

They all do. Excess nitrogen and imbalances of phosphorus, potassium, and/or calcium are generally more suspect in pest and disease problems.

5. In general, what is the minimum fertility program for sustainable production?

Replacement of nutrients removed by the crop

6. Explain the concepts of Cation Exchange Capacity (CEC) and Cation Saturation Ratios (CSR).

The clay and humus particles in the soil have a negative charge. Positively charged ions (e.g., of Ca, Mg, K, Na, H, etc.) are adsorbed to the surfaces of clay and humus, where they can be exchanged with other cations in the soil solution, on plant roots or held tightly, depending on conditions. CSR is the ratio of Ca, Mg, K, and Na on the exchange sites, and is a major factor in soil fertility and structure.

7. What are several advantages of optimum soil cation balance?

Optimum soil tilth, aeration, drainage, nutrient availability, biological activity, organic matter breakdown, and minimized toxic elements

8. What are the three primary sources of nitrogen factored into a nitrogen budget for an organic farming system?

Compost, the estimated nitrogen release (ENR) from soil organic matter, and the nitrogen contributed by nitrogen-fixing cover crops

Resources

SUGGESTED READINGS

A and L Western Agricultural Laboratories, Inc. Reference Guides: “Soil Sampling” and “Soil Analysis” 1311 Woodland Ave. #1 Modesto, CA 95351. 209.529-4080.

The two four-page pamphlets above provide an overview of basic soil sampling procedures and the soil properties measured in an A & L soil analysis report. Available from www.al-labs-west.com/index.html.

Gaskell, Mark, Jeff Mitchell, Richard Smith, Steven Koike, and Calvin Fouche. 2000. *Soil Fertility Management for Organic Crops*. Publication 7249. Oakland, CA: University of California Division of Agriculture and Natural Resources. anrcatalog.ucdavis.edu/pdf/7249.pdf

An 8-page overview of soil fertility for organic production systems.

PRINT

A and L Western Agricultural Laboratories, Inc. *Agronomy Handbook: Soil And Plant Analysis*. Modesto, CA: California Laboratory.

A concise and practical handbook designed to be used in association with A and L soil analysis testing services. Provides an overview of general properties of soils and recommendations on the management of all essential soil and plant nutrients. Includes useful tables on crop removal estimates, crop deficiency symptoms, nutrient composition of common fertilizers and amendments comprehensive section on plant analysis. Order from A & L Western Laboratories; see www.al-labs-west.com/files/order.pdf

Albrecht, William A., and C. Walters (eds). 1975. *The Albrecht Papers, I, II and III*. Raytown, MO: Acres USA.

Provides an overview of William Albrecht’s agronomic research and outlines the rationale behind his suggestions of base cation saturation ratios.

California Fertilizer Association. 2001. *The Western Fertilizer Handbook, 9th Edition*. Long Grove, IL: Waveland Press, Inc.

This handbook presents fertilization, nutrient management, and related topics based on the fundamentals of biological and physical sciences.

Cantisano, Amigo. 2012. *Know Your Soil: A Handbook for Understanding and Utilizing a Soil Analysis for Organic Growing, Third Edition*. Organic Ag Advisors.

Gugino, B. K., O. J. Idowu, R. R. Schindelbeck et al. 2009. *Cornell Soil Health Assessment Training Manual, 2nd Edition*. Ithaca, NY: College of Agriculture and Life Sciences, Cornell University. soilhealth.cals.cornell.edu/extension/manual.htm

Comprehensive information on assessing soil health, including definitions, testing, and management strategies.

Hoskins, Bruce R. 1997. *Soil Testing Handbook for Professionals in Agriculture, Horticulture, Nutrient and Residuals Management, 3rd Edition*. University of Maine Soil Testing Service and Analytical Lab. anlab.umesci.maine.edu/soillab_files/faq/handbook.pdf

Extensive information on all aspects of soil testing and soil amendments. Many sections of this online publication have been updated since the 1997 publication date.

Magdoff, Fred, and Harold Van Es. 2010. *Building Soils for Better Crops, 3rd Edition*. Handbook Series Book 10, Sustainable Agriculture Research and Education (SARE) Program. www.sare.org/Learning-Center/Books/Building-Soils-for-Better-Crops-3rd-Edition

An introductory overview of organic management of soil fertility covering the basics of soil organic matter, physical, and chemical properties of soil, ecological soil and crop management. Practical and accessible information. Available from SARE as hard copy or free download.

Ribaudo, Marc, et al. 2011. *Nitrogen in Agricultural Systems: Implications for Policy*. ERS Report Summary. U.S. Department of Agriculture, Economic Research Service. http://www.ers.usda.gov/media/117600/err127_reportssummary.pdf

A brief report summarizing research on nitrogen use in agricultural systems. Discusses policies and incentives to encourage the use of best management practices that match nitrogen applications to crop needs.

University of Maine Soil Testing Service and Analytical Lab (N.D.). *Interpreting Soil Test Results for Commercial Crops*. anlab.umesci.maine.edu/soillab_files/under/commppam.pdf

This 12-page publication from the University of Maine's Cooperative Extension service offers a clear explanation of soil test interpretation and use of soil testing recommendations, including information on choosing a fertilizer blend and calculating manure application rates.

Van Horn, Mark. (N.D.) *Organic Soil and Fertility Management: Principles and Practices*. UC Davis: The Student Farm, Agricultural Sustainability Institute. www.sarep.ucdavis.edu/sf/files/Organic%20Soil%20and%20Fertility%20Management.pdf/view

An excellent 8-page summary of soil fertility management practices in organic systems: Addresses soil fertility needs, organic matter, determining crops' nutritional needs, soil testing, and the use of inputs such as cover crops, manures, compost, and mineral products in an easy-to-read, non-technical style.

Young, G. 1999. "Training Manual for Soil Analysis Interpretation in Northern California." Master's Thesis, California State University, Sonoma.

A thesis project developed for teaching farmers and extension agents how to read and interpret soil analysis reports. Includes summaries of studies of fertilizer use trends in northern California and those linking over fertilization with pest and disease problems. Emphasizes the research and recommendations of William Albrecht.

WEB-BASED RESOURCES

Alternative Farming Systems Information Center, USDA

afsic.nal.usda.gov/

Part of USDA's National Agricultural Library, the AFSIC site offers access to technical information on organic farming, sustainable agriculture, soil and water management, and other topics of interest to organic producers. See the soil and water management link, afsic.nal.usda.gov/soil-and-water-management, for information on soil testing, amendments, and nutrient management.

Analytical Lab and Maine Soil Testing Service

anlab.umesci.maine.edu/soillab_files/under/index.html

This University of Maine resource includes a number of web-based guidelines on understanding soil test recommendations, along with information on organic nutrient sources, soil management, and more.

Appropriate Technology Transfer for Rural Areas: Soils & Compost

attra.ncat.org/soils.html

ATTRA is a national center for sustainable farming information. The soils and compost page of the ATTRA website lists numerous publications on soil management and soil amendments.

Determining Nutrient Needs for Organic Vegetables: Basic Calculations, Penn State Extension

extension.psu.edu/business/start-farming/soils-and-soil-management/determining-nutrient-applications-for-organic-vegetables-basic-calculations-introduction-to-soils-fact-3

Fundamentals of Soil Cation Exchange Capacity

www.extension.purdue.edu/extmedia/ay/ay-238.html

Clear explanation of CEC, by Purdue agronomist David B. Mengel

Interpreting Missouri Soil Test Reports

muextension.missouri.edu/xplor/agguides/soils/g09112.htm

University of Missouri website explains how to interpret soil test results and recommendations, and includes a useful FAQ section.

Interpreting Soil Tests for Efficient Plant Growth and Water Use, New Mexico State University

aces.nmsu.edu/pubs/_a/A141/welcome.html

Nutrient Cycling and Maintaining Soil Fertility in Fruit and Vegetable Crop Systems

www.extension.umn.edu/garden/fruit-vegetable/nutrient-cycling-and-fertility/#nutp

Ohio Agronomy Guide, Bulletin 472: Soil Fertility
agcrops.osu.edu/specialists/fertility/fertility-fact-sheets-and-bulletins/agron_guide.pdf

Includes a useful section on soil fertility.

Organic Materials Review Institute

www.omri.org

Lists materials, including fertilizers and other soil inputs, compatible with U.S. National Organic Program (NOP) standards. Includes brand name reviews, manufacturer contacts, and technical information.

Peaceful Valley Farm Supply

www.groworganic.com

A catalogue of tools and supplies and technical support for organic farmers and gardeners, including soil testing service and soil test kits.

Selecting an Analytical Laboratory, Colorado State University

www.ext.colostate.edu/pubs/crops/00520.html

Soil Cation Ratios for Crop Production

www.extension.umn.edu/agriculture/nutrient-management/soil-and-plant-sampling/soil-cation-ratios/

Addresses the history of the “basic cation saturation ratio” concept and examines its importance and relevancy for crop production.

Soil Test Explanation, Colorado State University

www.ext.colostate.edu/pubs/crops/00502.html

Soil Testing, Clemson University Cooperative Extension Home & Garden Information Center

www.clemson.edu/extension/hgic/plants/other/soils/hgic1652.html

UC Sustainable Agriculture Research and Education Program (UC SAREP)

www.sarep.ucdavis.edu/sarep

Sustainable agriculture news, technical information, grant programs, and other information from the University of California.

UC SAREP Solution Center for Nutrient Management

www.sarep.ucdavis.edu/sarep/sarep-solution-centers

An online information resource on nutrient management; provides opportunities to engage with researchers and farmers on pressing nutrient management needs. Includes forums, database, and decision-making tools.

Understanding the Numbers on Your Soil Test Report, University of Arkansas

www.uaex.edu/publications/PDF/FSA-2118.pdf

USDA National Organic Program.

www.ams.usda.gov/AMSV1.0/nop

Regulations on certification, materials, and labeling for organic producers and processors.

SUPPLEMENT 1

Soil Contamination & Urban Agriculture

Urban agriculture promises to be an increasingly important part of the movement towards a sustainable and equitable food system. Urban farms and garden provide a local source of fresh vegetables in areas that often lack physical or economic access, reduce transportation, storage, and other environmental costs or industrial production, concentrate and support investment in the local economy, and provide communities with access to open spaces.

Contaminated soils present a significant challenge to the viability of urban food growing as many undeveloped areas in cities contain high levels of heavy metals hazardous to human health. Moreover, there is evidence to show that contamination is worse in poorer, communities of color where access to fresh food is often least available. Addressing soil contamination in urban areas is necessary to alleviate not only the health safety concern it raises, but also the food security and environmental justice implications from disproportionately high contamination levels in poorer communities. The sources of contaminated urban soils are introduced, contaminants of concern are mentioned, and resources for remediating soils are listed in this case study.

Urban soils in close proximity to large human populations are exposed to a variety of harmful substances. Past and current land uses and adjacent activities contribute to the level of contamination in the soil. Contaminating substances like pesticides and herbicides are intentionally applied to urban soils while industrial chemicals enter soils most often through accidental spills or leaks. Air and waterways can also deposit dust and other contaminants from farther distances. While soil on former industrial sites may contain a wider range of contaminants, the most common, and therefore most concerning, substances in urban settings are lead, cadmium, arsenic, zinc, and hydrocarbons. Because poverty limits housing choices, low-income families are generally located in communities nearest commercial and industrial parts of a city, with the oldest housing, and the most deferred maintenance; all of these are factors that increase their exposure to hazardous contaminants. In addition to a higher exposure risk, higher soil contamination levels prevent communities most in need of a real source of fresh, healthy, affordable food from starting farms and gardens where they live.

Sources of Contamination

- **Lead:** By far the most prevalent toxic substance in urban areas, was historically used in paint formulations, as a gasoline additive, and in pesticides
- **Cadmium:** Byproduct of sewage sludge and coal and garbage burning
- **Arsenic:** Commonly used as a wood preservative and, along with Zinc, is an ingredient in pesticides, herbicides, and fertilizers
- **Hydrocarbons:** Found in car emissions and other combustion activities.

While legal recourse may be available to some individuals and communities who attempt an urban agricultural project on land contaminated from previous uses, in reality, this relief is often unavailable. Litigation is prohibitively expensive for most communities and, even if expense is of no concern, proving who is responsible for the contamination and, hence, the cleanup costs is exceedingly difficult. As a result, people interested in growing food in urban areas are left to take precautionary and remediating measures on their own. Assessments, remediation, and non-remediation solutions can be expensive, yet necessary measures to ensure the safety of a particular site before food can be grown there.

A soil test is the first step towards understanding the extent of contamination on a given plot. Urban soil tests require testing for specific metals, often not included in the generally affordable soil fertility tests described in the lecture outline. Testing for metals of concern in urban areas can cost anywhere from \$20-100 per metal, making them more expensive than what many individuals or groups can afford

when starting a farm or garden. To cut down on costs, urban gardeners should consult with local libraries for historical land use information about their site to determine which of the several contaminants potentially present are most important to test for. For example, if a plot was previously a gasoline station, hydrocarbons and benzene should be tested. Additionally, some cities, such as Minneapolis, provide free testing for individual and have funds available for groups starting community gardens. The EPA offers grants for assessing contamination at designated brownfields through the EPA Brownfields Assessment Grant program, and some states have initiated similar grant programs. People interested in growing food in contaminated urban areas who are not responsible for the contamination should not be burdened with the cost of assessment and remediation, and ought to advocate for access to state and local funds for such purposes.

Once contamination is found, the next step is to determine what remediation measures, if any, can be successfully implemented. There are physical and biological remediation techniques commonly used in urban gardens. Most of the physical measures are high-cost and high-input, including excavation and replacement of all the soil or soil washing, which requires off-site treatment. Biological remediation measures use living organisms (microbes, plants, or fungi) to degrade or extract contaminants from the soil. The effectiveness of each technique depends to a great degree on the specific contaminant(s) targeted. Biological remediation is low-cost and low-impact, but is also a slower process. Remediation

can take several years depending on the level of contamination, and with phytoremediation in particular, the plants that accumulate contaminants in their tissue must be disposed of off-site. As urban farming and gardening continue to develop as a significant source of food for urban communities, research into biological remediation must also increase so its practice can be scaled up to the future land needs of urban populations.

The slow process, limited effectiveness, and even cost of biological remediation, however, may be unsuitable for highly contaminated areas in poor urban communities. In cases where remediation is not possible, there are other non-remediation measures available to urban farmers and gardeners. The most common solution is to build raised beds and grow in clean, imported soil above the contaminated soil. Laying landscape fabric, biochar, or other barriers between the contaminated and clean soil will also help prevent plant roots from taking up contaminants. Again, public funds are available in some places for these mitigation measures, and with continued advocacy, more funds will be dedicated to this purpose.

Choosing fruiting crops over root or leafy green crops is another precautionary measure that limits the risk of plants absorbing contaminants, as they have less contact with the compromised soil. Finally, metals are more bioavailable—available for plant uptake—in acidic soils, so maintaining a non-acidic neutral pH (6.5-7) is another cultural technique that can minimize contamination of plant material.

Resources on Urban Agriculture

Guide to Implementing the Urban Agriculture Incentive Zones Act

ucanr.edu/sites/UrbanAg/files/190763.pdf

This easy-to-read 4-page guide describes California's AB 551 act and how it can be used to create new Urban Agriculture Zones.

Lead Hazard Risk Assessment and Management of Urban Gardens and Farms

www.sfdph.org/DPH/files/EHSdocs/ehsCEHPdocs/Lead/LeadHazardUrbanGardening.pdf

Developed by San Francisco's Department of Public Health, this guide includes protocols for conducting Lead Hazard Risk Assessment (LHRA) for urban gardens or farms and for managing and mitigating identified hazards.

Urban Agriculture – San Francisco

www.sfenvironment.org/buildings-environments/urban-agriculture

Example of a city-run website that offers “one stop shopping” for key information on urban agriculture and contacts for appropriate city officials.

Urban Agriculture – University of California, Division of Agriculture and Natural Resources

ucanr/sites/UrbanAg

Information on a wide variety of topics related to urban agriculture, including zoning laws and regulations, soil considerations, community and school gardens, and business management.

Appendix 1: Sample Soil Analysis Reports

A & L WESTERN AGRICULTURAL LABORATORIES
 1311 WOODLAND AVE #1 • MODESTO, CALIFORNIA 95351 • (209) 529-4080 • FAX (209) 529-4736



REPORT NUMBER: 13-284-063

CLIENT NO: 99999

SEND TO: CONSERVATION CORPS NORTH BAY
 11 PIMENTEL COURT
 NOVATO, CA 94949

GROWER:

SUBMITTED BY:

Graphical Soil Analysis Report

DATE OF REPORT: 10/16/13

LAB NO: 54997

SAMPLE ID: ZONEA

PAGE: 1

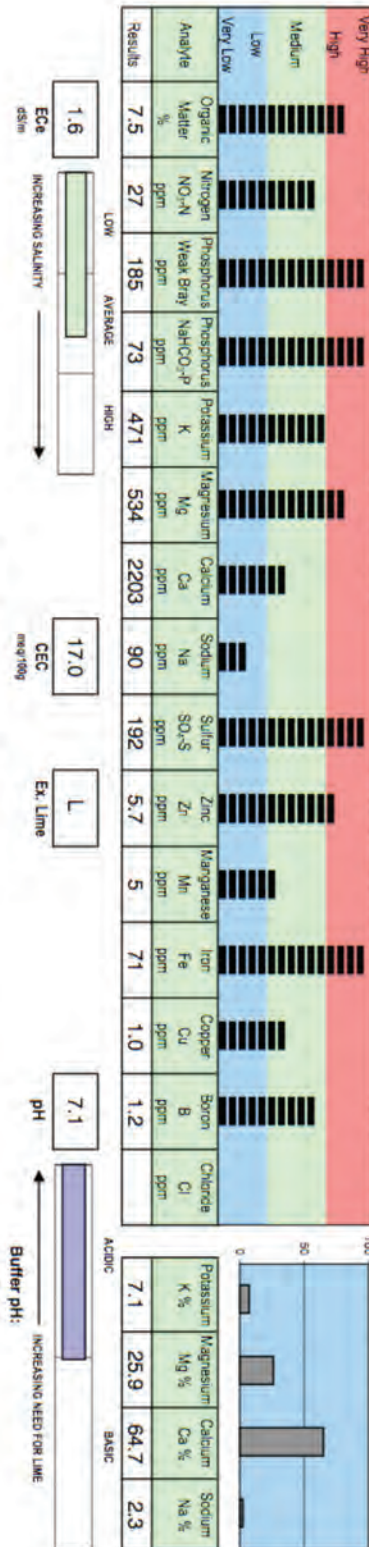

CROP: MIXED VEG

Soil Fertility Guidelines

RATE: lb/1000 sq ft

NOTES:

Doctonite (70 score)	Lime (70 score)	Gypsum	Elemental Sulfur	Nitrogen N	Phosphate P ₂ O ₅	Potash K ₂ O	Magnesium Mg	Sulfur SO ₄ -S	Zinc Zn	Manganese Mn	Iron Fe	Copper Cu	Boron B
				1.8									

Appendix 1: (cont.) Sample Soil Analysis Reports

REPORT NUMBER: 00-336-047

SEND TO: A & L WESTERN AGRICULTURAL LABS
1311 WOODLAND AVE.
MODESTO, CA 95351-

CLIENT NO: 9999-D

SUBMITTED BY:

GROWER: EXAMPLE REPORT

A & L WESTERN AGRICULTURAL LABORATORIES
1311 WOODLAND AVE #1 • MODESTO, CALIFORNIA 95351 • (209) 529-4080 • FAX (209) 529-4736



DATE OF REPORT: 04/30/04

SOIL ANALYSIS REPORT

PAGE 1

SAMPLE ID	LAB NUMBER	Organic Matter		P1 (Weak Bray)	Phosphorus (Olsen Method)	Potassium	Magnesium	Calcium	Sodium	Soil pH	Buffer Index	Hydrogen	Cation Exchange Capacity	PERCENT CATION SATURATION (COMPUTED)				
		% Rating	ENR lbs/A											ppm	ppm	ppm	ppm	ppm
130-1	55931	4.0H	110	23M	14**	110L	460M	992VL	104L	4.7	6.2	9.7	19.1	1.5	19.8	25.9	50.5	2.4
130-2	55932	1.5L	60	27H	6**	41VL	569M	1154VL	185M	4.6	5.9	13.3	24.7	0.4	19.0	23.3	54.0	3.3
12-1	55933	3.5M	100	12L	11**	64L	471VH	841VL	87L	5.2	6.5	4.5	13.1	1.2	29.5	31.9	34.5	2.9
12-2	55934	2.8M	86	8VL	9***	29L	553VH	665VL	89M	5.3	6.6	3.7	12.1	0.6	37.7	27.5	31.0	3.2

** NaHCO3-P unreliable at this soil pH

SAMPLE NUMBER	Nitrogen NO ₃ -N ppm	Sulfur SO ₄ -S ppm	Zinc Zn ppm	Manganese Mn ppm	Iron Fe ppm	Copper Cu ppm	Boron B ppm	Excess Lime Rating	Soluble Salts mmhos/cm	Chloride Cl ppm	PARTICLE SIZE ANALYSIS			SOIL TEXTURE
											SAND %	SILT %	CLAY %	
130-1	5L	5L	0.3VL	3M	53VH	0.2VL	0.1VL	L	0.3L		44	25	31	CLAY LOAM
130-2	3VL	41VH	0.1VL	1VL	14M	0.2VL	0.1VL	L	0.6L		60	16	25	SANDY CLAY LOAM
12-1	2VL	5L	0.1VL	2L	50VH	0.1VL	0.3VL	L	0.2VL		42	36	23	LOAM
12-2	2VL	4L	0.1VL	1VL	53VH	0.1VL	0.2VL	L	0.1VL		40	35	25	LOAM

* CODE TO RATING: VERY LOW (VL), LOW (L), MEDIUM (M), HIGH (H), AND VERY HIGH (VH).
** ENR - ESTIMATED NITROGEN RELEASE
*** MULTIPLY THE RESULTS IN ppm BY 2 TO CONVERT TO LBS. PER ACRE OF THE ELEMENTAL FORM
**** MULTIPLY THE RESULTS IN ppm BY 4.6 TO CONVERT TO LBS. PER ACRE P₂O₅
***** MULTIPLY THE RESULTS IN ppm BY 2.4 TO CONVERT TO LBS. PER ACRE K₂O
MOST SOILS WEIGH TWO (2) MILLION POUNDS (DRY WEIGHT) FOR AN ACRE OF SOIL 6-2/3 INCHES DEEP

This report applies only to the sample(s) listed. Samples are retained a maximum of thirty days after testing.

MB

Mike Butters, CPAG
A & L WESTERN LABORATORIES, INC.

Appendix 1: (cont.) Sample Soil Analysis Reports

Your Logo Here

A&L Analytical Laboratories, Inc.

2790 Whitten Rd. Memphis, TN 38133 (901) 213-2400 Fax (901) 213-2440

<http://www.aialabs.com>



The One Source.

SOIL ANALYSIS

Client : JOHN DOE 1311 SOME STREET ANYWHERE TN 38105	Grower : SUE DOE Date Received : 01/07/2003	Report No: 03-600-0500 Cust No: 99999 Date Printed: 01/07/2003 Page : 1 of 1 A&L Agronomist Richard Large
---	---	--

Lab Number : 60000

Sample Id : 1

Signature :

Test	Results	SOIL TEST RATINGS					Calculated Cation Exchange Capacity
		Very Low	Low	Medium	Optimum	Very High	
Soil pH	4.9						11.4 meq/100g
Buffer pH	6.83						
Phosphorus (P)	34 LB/ACRE						Calculated Cation Saturation %K 0.9 %Ca 13.8 %Mg 1.8 %H 82.1 %Na 1.1 K : Mg Ratio 0.52
Potassium (K)	84 LB/ACRE						
Calcium (Ca)	628 LB/ACRE						
Magnesium (Mg)	50 LB/ACRE						
Sulfur (S)	50 LB/ACRE						
Boron (B)	1.6 LB/ACRE						
Copper (Cu)	8.0 LB/ACRE						
Iron (Fe)	204 LB/ACRE						
Manganese (Mn)	310 LB/ACRE						
Zinc (Zn)	7.0 LB/ACRE						
Sodium (Na)	60 LB/ACRE						
Soluble Salts							
Organic Matter	1.5 % ENR 74						
NO3-N							

SOIL FERTILITY GUIDELINES

Crop : CHRISTMAS TREE-LEYLAND CYPRESS Yield Goal : 1 Rec Units: LB/ACRE

LIME	N	P ₂ O ₅	K ₂ O	Mg	S	B	Cu	Mn	Zn
7500	60	50	100	25	0	0	0	0	0
Crop :		Yield Goal :			Rec Units:				

Comments :

CHRISTMAS TREE-LEYLAND CYPRESS

APPLY 2/3 OF THE FERTILIZER IN THE SPRING AND 1/3 IN MID SUMMER
Limestone application is targeted to bring soil pH to 6.0.

Appendix 1: (cont.) Sample Soil Analysis Reports with Recommendations

Soil Report

Job Name Sample Job Date 1/1/2007

Submitted By Logan Labs Sales Person _____

Sample Location		Field	Field	Field	Field	Field	
Sample ID		# 1	# 2	# 3	# 4	# 5	
Lab Number		46	47	48	49	50	
Sample Depth in inches		6	6	6	6	6	
Total Exchange Capacity (M. E.)		11.85	13.93	12.39	12.77	13.87	
pH of Soil Sample		6.60	7.00	6.90	6.80	6.80	
Organic Matter, Percent		2.16	1.94	2.23	2.27	2.25	
ANIONS	SULFUR: p.p.m.	12	13	8	8	12	
	Mehlich III Phosphorous: as (P ₂ O ₅) lbs / acre	74	95	55	67	69	
EXCHANGEABLE CATIONS	CALCIUM: Desired Value lbs / acre	3223	3787	3369	3472	3773	
	Value Found	3170	3858	3392	3398	3842	
	Deficit	-53			-74		
	MAGNESIUM: Desired Value lbs / acre	341	401	356	367	399	
	Value Found	547	796	688	716	685	
	Deficit						
	POTASSIUM: Desired Value lbs / acre	369	434	386	398	432	
	Value Found	180	185	145	153	178	
	Deficit	-189	-249	-241	-245	-254	
	SODIUM: lbs / acre	63	52	51	56	61	
	BASE SATURATION %	Calcium (60 to 70%)	66.88	69.26	68.45	66.54	69.24
		Magnesium (10 to 20%)	19.23	23.82	23.14	23.37	20.58
Potassium (2 to 5%)		1.95	1.70	1.50	1.54	1.65	
Sodium (.5 to 3%)		1.16	0.81	0.90	0.96	0.95	
Other Bases (Variable)		4.80	4.40	4.50	4.60	4.60	
Exchangable Hydrogen (10 to 15%)		6.00	0.00	1.50	3.00	3.00	
TRACE ELEMENTS	Boron (p.p.m.)	0.69	0.69	0.65	0.72	0.73	
	Iron (p.p.m.)	131	152	135	147	166	
	Manganese (p.p.m.)	122	141	156	142	127	
	Copper (p.p.m.)	1.46	1.89	1.67	2.41	2.03	
	Zinc (p.p.m.)	1.06	1.41	1.06	2.69	1.97	
	Aluminum (p.p.m.)	713	665	667	650	685	
OTHER							

Logan Labs, LLC

Appendix 2: Example of a Nitrogen Budget

NITROGEN REMOVAL		1) 150 lbs N/acre (spinach) (Estimated total N lost to crop removal)
NITROGEN CONTRIBUTIONS		
Soil Organic Matter Estimated Nitrogen Release (ENR) Example ENR: 10 lbs/ac	<ul style="list-style-type: none"> Use 60–80% of Estimated Nitrogen Release (ENR) on Soil Test for annual and perennial crops, respectively. 110 lbs/acre (110 x .60) = 66 lbs/acre of actual N 	2) 66 lbs N/acre (Estimated nitrogen released in the first year from soil organic matter)
Compost * Moist compost is ~35% moisture by weight. This needs to be subtracted from the total compost weight. (0.35 x total compost weight = amount to subtract from total to get dry weight)	<ul style="list-style-type: none"> Average application rate: 5–7 tons/acre/year of compost ~1 % nitrogen content 10,000–14,000* lbs x .01 = 65–91 lbs actual N with ~50% available in the first year = 32.5–45 lbs N 	3) 32.5–45 lbs N/acre (Estimated nitrogen released N released in the first year from compost)
Legume Cover Crops	<ul style="list-style-type: none"> Estimated N fixation by Bell Beans = 100 lbs/ acre Estimated % N Available in first season after incorporation = 50% 100 lbs X .50 = 50 lbs estimated lbs of actual N available in first season after incorporation 	4) 50 lbs. N/acre (Estimated N contribution of fabaceous cover crops)
Total Available Nitrogen	<ul style="list-style-type: none"> 66 lbs + 45 lbs + 50 lbs = 161 total lbs of actual N/acre 	5) 161 lbs N/acre (Estimated total available nitrogen/acre)
Calculating Additional Nitrogen Needs	<ul style="list-style-type: none"> Line 1 (Total N lost to crop removal) – Line 5 (Total Available Nitrogen) 150 lbs – 161 lbs = 11 lbs N/acre surplus. No supplemental N needed <p>Note: Seasonal environmental conditions (e.g., cool and wet soils) may create growing conditions that may depress mineralization and N availability, thereby creating a demand for supplemental fertilizer despite the presence of adequate quantities of N in the soil. This relatively low excess should not lead to losses to the environment if nutrient release is properly timed with crop demand.</p>	

Appendix 3: Nitrogen Budgeting Worksheet

<p>NITROGEN REMOVAL</p> <p><i>(See Appendix 6, Nutrients Removed by Common Crops)</i></p>		<p>1) _____ lbs.N/acre (Estimated average total N lost to crop removal)</p>
NITROGEN CONTRIBUTIONS		
<p>Soil Organic Matter Estimated Nitrogen Release (ENR)</p> <p><i>(See soil analysis report for ENR figures)</i></p>	<ul style="list-style-type: none"> • Estimated Nitrogen Release (ENR) on Soil Test _____ x 60–80% (for annual and perennial crops, respectively) 	<p>2) _____ lbs.N/acre (Estimated nitrogen released in the first year from soil organic matter)</p>
<p>Compost</p> <p>* Moist compost is ~35% moisture by weight. This needs to be subtracted from the total compost weight. (0.35 x total compost weight = amount to subtract from total to get dry weight)</p>	<ul style="list-style-type: none"> • Application rate: _____ tons/acre/year of compost • Average N content of compost = _____% • _____ lbs. compost* x %N of compost = _____ lbs. actual N applied • Average N available in the first year = 50% • _____ lbs. actual N applied x .050 = ENR of compost 	<p>3) _____ lbs N/acre (Estimated nitrogen released N released in the first year from compost)</p>
<p>Legume Cover Crops</p> <p><i>(See Unit 1.6 for estimating N contribution of cover crops)</i></p>	<ul style="list-style-type: none"> • Estimated N fixation by cover crop = _____ lbs/ acre • Estimated % N Available in first season after incorporation = 50% • _____ lbs. X .50 = _____ lbs. estimated lbs of actual N available in first season after incorporation 	<p>4) _____ lbs. N/acre (Estimated N contribution of fabaceous cover crops)</p>
<p>Total Available Nitrogen</p>	<ul style="list-style-type: none"> • _____ lbs. + _____ lbs. + _____ lbs. = _____ total lbs of actual N/acre 	<p>5) _____ lbs. N/acre (Estimated total available nitrogen/acre)</p>
<p>Calculating Additional Nitrogen Needs</p>	<ul style="list-style-type: none"> • Line 1 _____ (Total N lost to crop removal) – Line 5 _____ (Total Available Nitrogen) 	<p>6) _____ lbs. N/acre (Total needed supplemental nitrogen in lbs./acre)</p>

* Note on the accuracy of the above mineralization figures: The C:N ratio of organic matter, climate and weather patterns, the presence of lignins and tannins on the organic matter, soil biological activity, soil moisture, and the placement of the organic matter amendments in the soil profile are all influential factors in determining the mineralization rate of organic matter. Therefore, the accuracy of the mineralization rates listed in the Nitrogen Budgeting Worksheet above must be understood in this light and represent only rough estimates.

Appendix 4: Optimum Nutrient Levels (in ppm) of Major Cations Based on CEC

CEC of Soil	Ca 65%	Ca 75%	Mg 10%	Mg 15%	K 3%	K 5%	Na <5%
2	260	300	24	37	23	39	23
3	390	450	37	55	35	59	35
4	520	600	49	73	47	78	46
5	650	750	61	92	59	98	58
6	780	900	73	110	70	118	69
7	910	1050	85	128	82	137	81
8	1040	1200	98	146	94	157	92
9	1170	1350	110	165	105	176	104
10	1300	1500	122	183	117	196	115
11	1430	1650	134	201	129	216	127
12	1560	1800	146	220	140	235	138
13	1690	1950	159	238	152	255	150
14	1820	2100	171	256	164	274	161
15	1950	2250	183	275	176	294	173
16	2080	2400	195	293	187	314	184
17	2210	2550	207	311	199	333	196
18	2340	2700	220	329	211	353	207
19	2470	2850	232	348	222	372	219
20	2600	3000	244	366	234	392	230
25	3250	3750	305	458	293	490	288
30	3900	4500	366	549	351	588	345
35	4550	5250	427	641	410	686	403
40	5200	6000	488	732	468	784	460
TOTAL EXCHANGE CAPACITY	CALCIUM LEVEL should be between these levels		MAGNESIM LEVEL should be between these levels		POTASSIUM LEVEL should be above first and near or below second		SODIUM LEVEL should be below this

Sample calculations:

FOR ANY CEC:	PPM OPTIMUM	MINUS	PPM TESTED	EQUALS	PPM NEEDED
CEC	ppm Ca (optimum)		ppm Ca (tested)		ppm needed
11	1430 – 1650	-	950	=	480 – 700
44 = 200 pounds/1000 sq feet.					
CEC	ppm Mg (optimum)		ppm Mg (tested)		ppm needed
11	134 – 201	-	287	=	0

To calculate pounds or tons of amendments, multiply amount needed (ppm) by 4 to get pounds per acre-foot. Then divide amount needed in pounds by percent of element in the amendment. Ex:ample: Limestone, 32% Ca; 700 ppm needed x 4 = 2800 pounds/acre foot divided by .32 = 8,750 pounds divided by 2000 pounds = 4.4 tons/ac ft.. To calculate pounds per 1000 square feet (1 foot deep), divide pounds needed (8,750) by

Appendix 5: Nutrient Content of Common Fertilizers & Amendments

MATERIAL	% N-P-K	% Ca-Mg-S	MICRO-NUTRIENT	TOTAL LBS NUTRIENTS per 100 lbs	COST per 100 lbs	COST PER LB. OF NUTRIENT	COMMENTS
SYNTHETIC MINERALS							
Ammonium sulfate	21-0-0	0-0-24		45			SOL-AC
Urea	46-0-0	—		46			SOL-AC
Calcium nitrate	15-0-0	19-0-0		34			SOL
Ammonium nitrate	34-0-0	—		34			SOL-AC
Super phosphate	0-20-0	25-0-0		50			SOL
Diammonium phosphate	18-48-0	—		66			SOL-AC
Nutricote	14-14-14	—		34			SOL-AC
Osmacote	14-14-14	—		34			SOL-AC
N-P-K Blend	—						SOL
Potassium sulfate	0-0-50	0-0-18		68			SOL
MINED MINERALS							
Rock Phosphate	0-25-0	25-0-0	+	50			SR
Sulfate of potash	0-0-50	0-0-18	+	68			SR
Greensand	0-2-7	—	+	9			SR
Sulfur	0-0-0	0-0-90	+	90			SR-AC
CALCIUM AMENDMENTS							
Shell limestone	—	39-1-0	+	40			SR
Dolomite	—	20-10-0	+	30			SR
Gypsum	—	22-0-16	+	38			SR
Hydrated (Ag) lime	—	70-0-0		70			SOL
Mined limestone	—	36-1-0	+	37			SR
Hardwood ash	0-2-5	20-2-0	+	29			SOL
ORGANIC MATTER FERTILIZERS & AMENDMENTS							
Fish emulsion	4-2-2	1-0-0	+	9			SOL-RAW
Fish powder	12-1-1	1-0-0	+	15			SOL-RAW
Blood meal	13-0-0	—	+	13			SR-RAW
Cottonseed meal	7-2-2	—	+	11			SR-RAW
Bat guano	10-4-1	1-0-0	+	16			SR-RAW
Chicken manure	3-2-1	3-0-0	+	9			SR-RAW
Steer manure	1-1-1	—	+	3			SR-RAW
Bonemeal	2-15-0	20-0-0	+	37			SR
Mushroom waste	1.5-1-1.5	3-0-0	+	7			SR-RAW
Agricultural compost	1.5-1-1.5	2-0-0	+	6			SR
N-P-K Organic Blend	7-5-7	1-0-0	+	20			SR

SOL Soluble, quick acting, leaches out easily RAW Requires digestion before plant uptake SR Slow release, less leaching AC Acidifies soil

Appendix 6: Approximate Pounds/Acre of Nutrients Removed by Common Crops

CROP	YIELD	NITROGEN	PHOSPHATE	POTASH	CALCIUM	MAGNESIUM	SULFUR
GRAINS							
Corn	200 bu	300	120	260	42	30	32
Rice	150 bu	150	60	160	24	17	18
Soybeans	60 bu	330	72	144	102	14	27
Wheat	74 bu	158	54	120	20	18	17
HAY - LEGUMES							
Alfalfa	10 tons	600	140	500	280	50	50
Vetch	5 tons	275	75	225	120	25	25
HAY - GRASSES							
Coastal Bermuda	10 tons	500	120	350	75	45	60
Timothy	5 tons	180	68	220	40	24	14
FRUITS AND VEGETABLES							
Apples	21 tons	175	75	320	100	40	40
Cabbage	30 tons	195	72	240	72	30	66
Celery	50 tons	260	110	500	130	40	70
Cucumbers	20 tons	180	60	300	160	40	32
Grapes	10 tons	55	20	100	10	7	11
Lettuce	20 tons	140	46	200	56	14	16
Onions	15 tons	90	41	80	24	9	36
Oranges	30 tons	270	60	270	210	52	30
Peaches	15 tons	116	30	150	101	24	21
Pears	20 tons	118	48	174	102	28	25
Potatoes	25 tons	150	75	250	10	12	8
Spinach	15 tons	150	45	90	36	15	12
Tomatoes	30 tons	120	36	210	15	15	21
Turnips	12 tons	154	34	168	65	12	22
Mixed Vegetable Average		130	54	218	78	21	29

From Soil and Plant Analysis, A&L Western Laboratories, 1974; Western Fertilizer Handbook, 1980; Nutrient Deficiencies & Toxicities in Crop Plants, 1993.

Applied Soil Science

Unit 2.1: Soils and Soil Physical Properties	3
Unit 2.2: Soil Chemistry and Fertility	49
Unit 2.3: Soil Biology and Ecology	83

Soils and Soil Physical Properties

Introduction	5
Lecture 1: Soils—An Introduction	7
Lecture 2: Soil Physical Properties	11
Demonstration 1: Soil Texture Determination	
Instructor's Demonstration Outline	23
Demonstration 2: Soil Pit Examination	
Instructor's Demonstration Outline	28
Supplemental Demonstrations and Examples	29
Assessment Questions and Key	33
Resources	37
Glossary	40

Introduction: Soils & Soil Physical Properties

UNIT OVERVIEW

This unit introduces students to the components of soil and soil physical properties, and how each affects soil use and management in farms and gardens.

In two lectures, students will learn about soil-forming factors, the components of soil, and the way that soils are classified. Soil physical properties are then addressed, including texture, structure, organic matter, and permeability, with special attention to those properties that affect farming and gardening.

Through a series of demonstrations and hands-on exercises, students are taught how to determine soil texture by feel and are given the opportunity to examine other soil physical properties such as soil structure, color, depth, and pH. The demonstrations offer an opportunity to discuss how the observed soil properties might affect the use of the soil for farming and gardening.

MODES OF INSTRUCTION

- > LECTURES (2 LECTURES, 1.5 HOURS EACH)
 - Lecture 1 introduces students to the formation, classification, and components of soil.
 - Lecture 2 addresses different concepts of soil and soil physical properties, with special attention to those properties that affect farming and gardening.
- > DEMONSTRATION 1: SOIL TEXTURE DETERMINATION (1 HOUR)
 - Demonstration 1 teaches students how to determine soil texture by feel. Samples of many different soil textures are used to help them practice.
- > DEMONSTRATION 2: SOIL PIT EXAMINATION (1 HOUR)
 - In Demonstration 2, students examine soil properties such as soil horizons, texture, structure, color, depth, and pH in a large soil pit. Students and the instructor discuss how the soil properties observed affect the use of the soil for farming, gardening, and other purposes.
- > SUPPLEMENTAL DEMONSTRATIONS AND EXAMPLES (1 HOUR)
 - These simple demonstrations offer ideas for using objects, samples, or models to illustrate by way of analogy various soil physical properties.
- > ASSESSMENT QUESTIONS (1 HOUR)
 - Assessment questions reinforce key unit concepts and skills.

LEARNING OBJECTIVES

CONCEPTS

- Soil formation
- Components of soil
- Soil physical properties: What are they?
- Factors that affect soil development and physical properties
- How soil physical properties affect their use for farming and gardening

SKILLS

- How to determine soil texture
- How to recognize different types of soil structure

REQUIRED READINGS (SEE RESOURCES SECTION)

Gershuny, Grace. 1993. *Start With the Soil*, Chapter 1; Chapter 2, pp. 27–38; Chapter 8, pp. 187–195; Chapter 9, pp. 200–205

Brady, Nyle C., and Ray R. Weil. 2008. *The Nature and Properties of Soils*. Chapter 1, 1.1–1.14

RECOMMENDED READINGS

Stell, Elizabeth P. 1998. *Secrets to Great Soil*, Chapter 1.

Lecture 1: Soils—An Introduction

Pre-Assessment Questions

1. What are some of the functions that soil serves?
2. What are some of the factors involved in soil formation?
3. What are the components that make up soil?

A. Introduction

1. What is soil?
 - a) Definitions
 - i. Different concepts = different definitions. How soil is defined depends on who is using the word.
 - Edaphological (in relation to plant growth)
A mixture of mineral and organic material that is capable of supporting plant life
 - Engineering (in relation to supporting structures)
Mixture of mineral material (sands, gravels, and fines [very small particles]) used as a base for construction
 - Pedological (looking at soil as a distinct entity)
The unconsolidated mineral or organic material on the surface of the earth arising from a particular parent material that has been subjected to and shows the effects of climate macro- and microorganisms, the topography of its location in the landscape, and time. It is at the Geosphere-Biosphere-Hydrosphere-Atmosphere interface.
 - b) Functions of soil
 - i. Supports growth of higher plants
 - ii. Primary factor controlling fate of water in hydrologic systems
 - iii. Nature's recycling system for nutrients
 - iv. Habitat for organisms
 - v. Engineering medium

B. How Soil Is Made

1. Soil-forming factors

At one time, people thought that soils were static. In the late 1800s, Russian soil scientists introduced the concept that soils are dynamic—that any one soil developed into the soil it is now and that it continues to evolve. The scientists came up with five soil-forming factors that influence how soils turn out the way they do. The idea is that if all five of the soil-forming factors are the same, then the soil will be the same. The technical term for soil formation is pedogenesis. The five soil-forming factors are:

 - a) Climate: Temperature, precipitation, and how they are distributed across the seasons
 - b) Biotic factors: Plants, animals, fungi, bacteria, and other microorganisms
 - c) Topography: Slope position, aspect, and shape
 - d) Parent material: Rock, alluvium (wind- or water-deposited material)
 - e) Time: How long the soil has been forming

2. Weathering: The five factors above affect weathering, the breakdown of rock into smaller and smaller pieces. Two types of weathering are recognized: chemical and mechanical (physical).
- Mechanical weathering is the breakdown of rock due to physical factors such as temperature fluctuations and freeze/thaw cycles of water. An example would be quartz breaking down to fine sand-sized particles (since quartz is resistant to chemical weathering, it doesn't get much smaller than this).
 - Chemical weathering refers to the breakdown of rock due to chemical reactions. For example, limestone (CaCO_3) and gypsum (CaSO_4) dissolve in water and become smaller and smaller compounds. Micas can lose potassium ions and become vermiculite. Vermiculite, in turn, can lose more potassium and become smectite. Feldspars lose potassium and become kaolinite. In these cases, rock weathers to a microscopic or even elemental state.

C. Soil Profiles and Soil Development

1. Soil horizons

Soils consist of one or more distinct layers called horizons. These layers are referred to as O, A, E, B, C and R depending on their position and nature

- **O:** Top layer dominated by organic material
- **A:** The mineral soil horizon that is usually at the surface or below an O horizon, generally called topsoil in agriculture. It has more organic carbon than underlying layers and is the best environment for plants and microbes to grow. Sometimes this layer is missing or reduced due to erosion or topsoil removal. Also, all surfaces resulting from plowing, pasturing, or similar disturbances are referred to as A horizons.
- **E:** Horizon characterized by eluviation (removal of materials such as silicate clay, iron, aluminum, or organic matter), if distinct from the A horizon. Frequently not present. Usually more pale colored than the A horizon.
- **B:** Horizon formed below an A, E, or O horizon that is dominated by loss of most or all of the original rock structure and shows evidence of soil formation such as illuviation (concentration of the silicate clay, iron, aluminum, or humus from higher horizons), development of soil color or structure, or brittleness.
- **C:** Horizons or layers, excluding hard bedrock, that are little affected by soil-forming processes and thus lack characteristics of O, A, E or B horizons
- **R:** The underlying bedrock

► **TABLE 2.1** | THE 12 MOST COMMON ELEMENTS IN THE EARTH'S CRUST

ELEMENT	% VOLUME	% WEIGHT
O^{2-}	90	47
Si^{4+}	2	27
Al^{3+}	1	7
Fe^{2+}	1	4
Mg^{2+}	1	2
Ca^{2+}	1	3
Na^+	1	2
K^{2+}	1	2
Ti^{4+}	trace	3
H^+	trace	1
Mn^{4+}	trace	1
P^{5+}	trace	1

D. What Is in Soil?

1. 40–50% mineral. Generally almost half of the soil is made up of non-biological particles of different sizes. The sizes present depend on the history of the soil, including the forces that formed it, how long it has been forming, and the parent material.
 - a) Rock particles too big to be soil: from gravel, to stones, to boulders
 - b) Large soil particles: Sand (0.05–2.00 mm)
 - c) Medium soil particles: Silt (0.002–0.05 mm)
 - d) Small soil particles: Clay (< 0.002 mm)
2. 0–10% biological (See ► Table 2.2, Soil Fauna and their Eating Habits, and ► Table 2.3, Common Populations of Some Soil Microorganisms). A small fraction of the soil is made up of biological organisms, or parts of organisms. The percent present depends on similar factors from the history of the soil, including how long it has been forming and the parent material, and is strongly influenced by environmental conditions.
 - a) Includes plants, animals, algae, bacteria, archaea, and fungi
 - b) Organisms may be alive or dead (when dead they become “organic matter”)
 - c) This includes both macroscopic organisms (organisms you can see with the naked eye, such as plant roots, rodents, earthworms, insects) and microscopic organisms (organisms you can see only with assistance, such as some fungi, bacteria, archae)
3. ~50% pore space
 Pore space consists of the “empty” spaces in the soil. This is a critical part of the soil because it is filled with either:
 - a) Air, which allows gas exchange for organisms (particularly CO₂ or O₂ for respiration)
 - b) Water, which is key for organismal function, and is especially important for plants via uptake by roots

◀ **FIGURE 2.1** | SOIL COMPOSITION: AN IDEALIZED SOIL

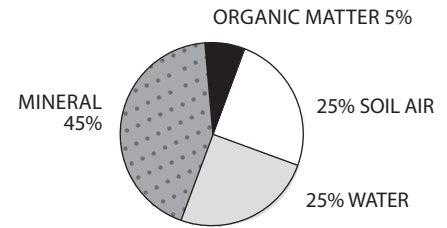

► **TABLE 2.2** | SOIL FAUNA AND THEIR EATING HABITS

MICROPHYTIC FEEDERS		CARNIVORES SECONDARY CONSUMERS		CARNIVORES TERTIARY CONSUMERS		
ORGANISM	MICROFLORA CONSUMED	PREDATOR	PREY	PREDATOR	PREY	
Springtails	Algae* Bacteria* Fungi*	Mites	Springtails* Nematodes* Enchytraeids	Ants	Spiders Centipedes Mites* Scorpions	
Mites	Fungi Algae Lichens	Centipedes	Springtails* Nematodes* Snails* Slugs* Aphids* Flies*			Centipedes
Protozoa	Bacteria and other microflora			Moles	Earthworms* Insects	Beetles
Nematodes	Bacteria Fungi					
Termites	Fungi					

*feed on live plants/plant residues, and/or soil organic matter

► **TABLE 2.3** | COMMON POPULATIONS OF SOME SOIL MICROORGANISMS

ORGANISM	NUMBER PER GRAM OF SOIL
Bacteria	$10^8 - 10^9$
Actinomycetes	$10^7 - 10^8$
Fungi	$10^5 - 10^6$
Algae	$10^4 - 10^5$
Protozoa	$10^4 - 10^5$
Nematoda	$10 - 10^2$

E. Soil Classification: 12 Orders

1. Soil scientists have come up with systems for classifying soils, in much the way plants and animals are classified. There are currently 4 main classification schemes: Russian, FAO, Canadian, and Soil Taxonomy (Euro-American in origin, but used worldwide). Soil taxonomy is similar to plant and animal classification in that the system is based on genesis—how it is thought the soil developed, similar to the evolutionary classification of plants and animals. Also, like plant and animal classification systems, soil taxonomy is not static. As more is learned, the system changes.
2. The highest category of this system is the Orders. There are 12 soil orders (see ► Table 2.4, 12 Orders in Soil Taxonomy).

► **TABLE 2.4** | 12 ORDERS IN SOIL TAXONOMY

Alfisols	form in areas with low rainfall, but wetter than deserts
Andisols	form in volcanic ash
Aridisols	form in deserts
Entisols	young soils (form in recently active areas, such as floodplains and mountains)
Gelisols	form in very cold climates, with permafrost near the surface
Histosols	soils very high in organic matter, common in wetlands
Inceptisols	fairly young soils, but with more soil development than Entisols
Mollisols	form in grasslands (such as the Midwestern prairies), have thick, dark, fertile soil
Oxisols	old soils formed in the tropics, have very low fertility
Spodosols	generally form in temperate coniferous forests, have very low fertility
Ultisols	form in humid temperate and tropical regions in older landscapes, are highly acidic with low fertility
Vertisols	soils rich in clay, which causes them to swell when wet and shrink (causing large cracks) when dry

Animals are classified first by kingdom, then phylum, then class, and so on down to species. Similarly, soils are classified first by order, then suborder, great group, and on down to series, the soil equivalent of species. Soils in a series have horizons that are similar in their key characteristics. Series names are usually taken from local geographic features or place names. There are over 20,000 recognized soil series in the U.S.

Lecture 2: Soil Properties

Pre-Assessment Questions

1. What are the mineral parts of the soil that create soil texture?
2. What are some of the factors affecting soil structure?
3. What makes up the organic matter component of soil?
4. What factors affect soil permeability and water holding capacity?

A. Soil Properties

1. Texture

Non-technical definition: How the soil feels to the touch

Technical definition: The proportions of sand, silt and clay in the soil

- a) Soil separates (mineral part of soil)
 - i. Sand particles are the largest in the soil, ranging in size from 0.05 to 2.00 mm. Soil with high sand content feels gritty and doesn't hold well in a ball.
 - ii. Silt particles are moderate size particles and range from 0.002 mm to 0.05. Soils high in silt feel floury when dry and greasy when wet.
 - iii. Clay particles are the smallest in the soil, with sizes less than 0.02 mm
 - Morphology: Most clay minerals consist of microscopic layers (see **Baklava Demonstration** in Supplemental Demonstrations and Examples). These are called phyllosilicate minerals. (*Phyllo-* is from Greek for leaf, as in phyllo dough used to make baklava.) Different types of clay have different kinds of layers and different properties.
 - Properties of clays (see several demonstrations in Supplemental Demonstrations and Examples):
 - Sticky (adhesion—sticks to other things) (**Target Demonstration**)
 - Plastic (cohesion—sticks to itself) (**Ribbon Demonstration**)
 - Shrink-swell (**Slinky Demonstration**)
 - Large surface area, due to layers and size (**Block Demonstration**)

Cation Exchange Capacity (CEC): Clay particles have a net negative charge, and so can attract positive ions (cations), hold them, and then release them to the soil water when its cations have been lost through leaching or plant uptake. Cations such as potassium (K^+), calcium (Ca^{+2}), magnesium (Mg^{+2}), iron (Fe^{+2} and Fe^{+3}), and zinc (Zn^{+2}) are essential plant nutrients, so the ability of soil to hold and release these ions later is important for plant growth and reproduction.

- b) Texture Triangle (see ◀ Figure 2.2, Soil Texture Triangle)

◀ FIGURE 2.2 | SOIL TEXTURE TRIANGLE

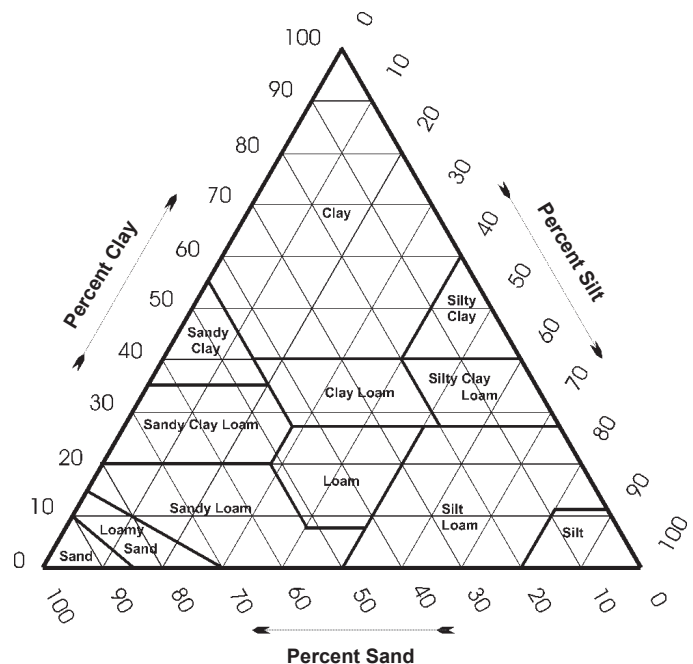

- i. There are 12 soil textures (see ► Table 2.5, 12 Soil Textures Names and their Abbreviations), varying in percentages of sand, silt, and clay

2. Structure

Structure is the arrangement of soil particles into aggregates, and the pore space around them

- a) Aggregates.
 - i. Aggregates can be natural or made by people (e.g., by tillage in wet soils; these aggregates are called clods)
 - ii. Types (shape) (See ◀ Figure 2.3, Soil Structure and Its Effects on Permeability)
 - Granular
 - Blocky (angular and sub-angular)
 - Platy
 - Columnar and prismatic
 - Single grain (non-structure)
 - Massive (non-structure)
 - iii. Size: Very fine, fine, medium, coarse, very coarse, thick, thin (see ► Table 2.6, Size Classes of Soil Structural Units)
 - iv. Aggregate stability is the ability to withstand wetting and drying, wind, and actions such as tillage. This is key for water infiltration, gas exchange, root growth, and long-term resistance to wind and water erosion, and is an indicator of soil health.
- b) What causes soil aggregates to form?
 - i. Biological factors help bind soil particles together
 - Bacterial exudates
 - Root activity and exudates (sugars that act as glue)
 - Fungal hyphae
 - Macrofauna (especially earthworm) activity and waste
 - High organic matter content
 - ii. Soils high in sand and silt do not form aggregates well. The type and quantity of clay particles greatly affects how well aggregates form and how they persist: Some types of clay form very stable aggregates, while other form weak aggregates.
 - iii. Calcium can help stabilize soils, although growers need to be aware of the type of calcium to apply depending on soil pH and the possibility of raising salinity. Overall, gypsum is an inexpensive and non-toxic source of calcium, although it should be used with care. See Resources and Unit 1.11, Reading and Interpreting Soil Test Reports for more specific information.
 - iv. Climate—especially the temperature and precipitation of an area—can affect soil aggregate formation. The physical action of freezing and thawing increases the likelihood of particles sticking together. Drying of soils can pull particles apart, as can the impact of raindrops.

► **TABLE 2.5** | 12 SOIL TEXTURES NAMES AND THEIR ABBREVIATIONS

clay	C	sandy loam	SL
sandy clay	SC	loam	L
silty clay	SIC	silt loam	SIL
clay loam	CL	loamy sand	LS
sandy clay loam	SCL	sand	S
silty clay loam	SICL	silt	SI

◀ **FIGURE 2.3** | SOIL STRUCTURE AND ITS EFFECTS ON PERMEABILITY

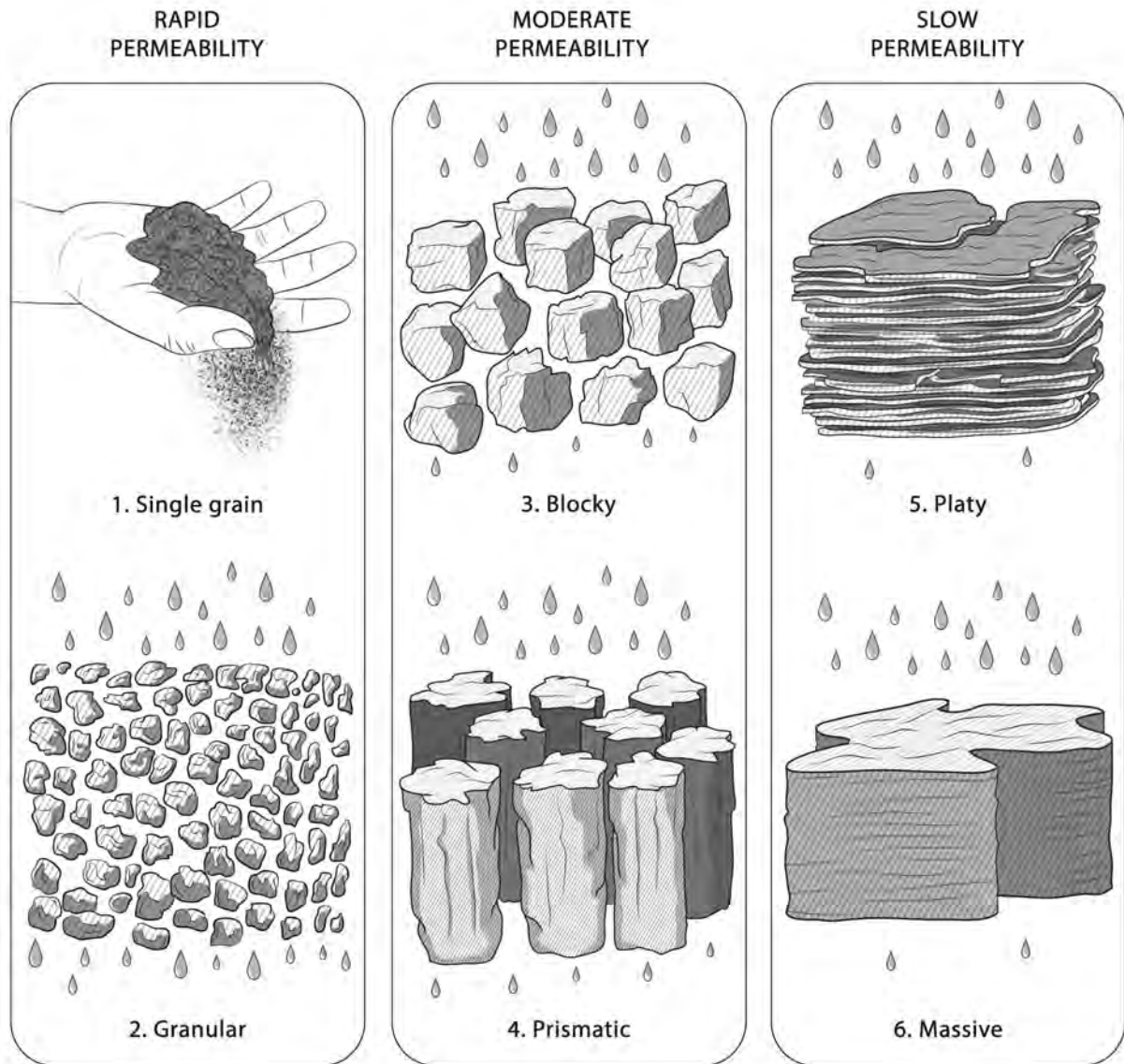

Illustration by José Miguel Mayo

▶ **TABLE 2.6** | SIZE CLASSES OF SOIL STRUCTURAL UNITS. THIN AND THICK, RATHER THAN FINE AND COARSE, ARE USED FOR PLATY STRUCTURES.

SIZE CLASS	PLATY	COLUMNAR/ PRISMATIC	BLOCKY	GRANULAR
very fine (thin)	<1 mm	<10 mm	<5 mm	<1 mm
fine (thin)	1 – 2 mm	10 – 20 mm	5 – 10 mm	1 – 2 mm
medium	2 – 5 mm	20 – 50 mm	10 – 20 mm	2 – 5 mm
coarse (thick)	5 – 10 mm	50 – 100 mm	20 – 50 mm	5 – 10 mm
very coarse (thick)	>10 mm	>100 mm	>50 mm	>10 mm

3. Pores

Pores are the spaces between soil particles or aggregates. They are important because they allow air and water to move through the soil and also to be stored there. Without air, roots, macroorganisms, and most microorganisms cannot live.

- a) Types of pores include:
 - i. Interstitial pores: Small spaces between soil particles or aggregates
 - ii. Tubular pores: Pores made by roots or animals
- b) Sizes of pores: Pores are generally broken up into two size classes, although there is not a particular size limit between them
 - i. Macropores: Allow free movement of air and water
 - ii. Micropores: Air movement is greatly impeded, water movement is restricted to capillary flow

4. Bulk density

The bulk density of the soil is the weight of a given volume of oven-dried soil divided by the volume, and reflects the amount of pore space in the soil. It is an indicator of soil health (e.g., see Unit 1.2, Garden and Field Tillage and Cultivation for a discussion of tillage's effect on bulk density).

- a) Factors that affect bulk density
 - i. Types of minerals that make up the soil particles: Some minerals are heavier than others
 - ii. Soil texture: Clays are lighter than silts and sands
 - iii. Organic matter content: Organic matter has a really low bulk density compared to mineral particles
 - iv. Soil compaction: Compacted soils have higher bulk densities than non-compacted soils
- b) How bulk density informs cropping

High bulk density indicates compacted soils that restrict root growth. Such soils need to be improved with practices such as cover cropping, incorporating crop residues, and using crops with various rooting depths to increase organic matter content.

**Bulk density is expressed in grams per cubic centimeter.
The formula is usually written like this:**

$$D_b = M_s/V_t$$

Where D_b = bulk density

M_s = mass of solids

V_t = total volume

Soil bulk density values range from 0.5 to 3.0 but most values are between 0.8 and 1.8. Anything denser than about 1.8 is root limiting.

FIGURE 2.4 | SOIL COMPOSITION:
AN IDEALIZED SOIL

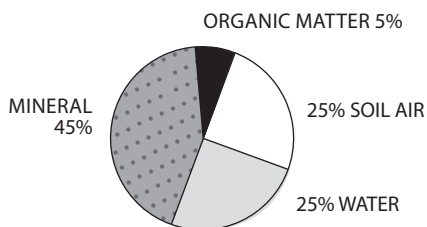

5. Organic matter

Organic matter consists of dead plants, animal, microbes and fungi or their parts, as well as animal and microbial waste products in various stages of decomposition. Eventually, all of these break down into humus, which is relatively stable in the soil.

a) Forms of organic matter

b) Importance of organic matter: Although organic matter makes up a minor part of the soil, it has a very strong impact on a number of factors

- i. Structure

Organic matter acts like glue that helps hold soil aggregates together. These will hold even upon wetting.
- ii. Available Water Capacity (AWC)

Organic matter helps bind water to the soil, keeping it from being lost through percolation and making it available to plants for uptake. This is especially important in sandy soils.
- iii. Cation Exchange Capacity (CEC) (see description of CEC under Texture)

Like clay particles, organic matter particles have a negative charge and thus attract, hold, and release cations necessary for plant growth and reproduction
- iv. Binding plant toxins

Organic molecules can bind up some ions that are toxic to plants
- c) Relationship to climate
 - i. The amount of organic matter soil can hold is really in equilibrium, like a bathtub that is receiving water at the same rate that water is going down the drain—the water molecules are moving in and out of the bathtub but the total volume in the tub stays constant. Organic matter added beyond a soil's equilibrium is "overflow," and is broken down to carbon dioxide and water.
 - ii. There is a maximum amount of organic matter that any particular soil can hold, and that amount is inversely proportional to soil temperature and moisture: wetter and colder soils can hold higher quantities of organic matter than warmer and drier soils. For example, peat soils of northern Canada and Europe have very high organic matter while soils of the Southwest U.S. tend to be very low in organic matter.
 - iii. Some researchers and growers are looking at the potential of organic and conservation tillage practices to increase soil OM. Increasing the total C content of the soil through high C inputs and minimal soil disturbance may increase the amount of OM in equilibrium, sequestering the C and offsetting emissions of CO₂.
- 6. Color

Soil color varies with parent material, how long the soil has been forming, and the environment itself

 - a) Describing soil color

Soil color is described using Munsell Color Notation (show *Munsell Soil Color Book*). The notation breaks soil color into hue (the particular color), value (how light or dark the color is), and chroma (how washed out or intense it is). The Munsell Soil books have color chips that allow scientists to precisely describe and compare soils.
 - b) Meaning of soil color
 - i. Drainage and wetness (also called "redoximorphic features") (show samples)

Greenish, bluish, and gray colors in the soil indicate wetness. These colors may occur as the dominant color (the matrix) or in patches (mottles). The colors are caused by the reduction of iron by bacteria in anaerobic conditions, when the bacteria get the electrons they need for energy from iron rather than from oxygen. These colors will persist even if the area is drained.

Bright colors (reds and yellows), indicate well-drained soils. However, color shouldn't be your sole indicator for determining the soil's suitability for crops. It is possible for a soil with bright colors to still have excess free water at points in the growing season if the groundwater is moving quickly and has sufficient oxygen or if it is too cold for biological activity.

ii. Organic matter

Dark colors in the soil usually indicate organic matter. However, they may also indicate wetness (remember, wetter soils can accumulate more organic matter). Sometimes dark colors may be derived from the parent material. This is often the case in soils that formed from dark-colored igneous rock.

7. Soil depth

Soil depth determines how far the roots can grow and how much water the soil can hold. Depth is measured to the shallowest root-limiting layer.

a) Factors that can limit soil depth:

i. Bedrock

ii. Hardpans

- Densely compacted material (tillage pan or plow pan): Can form when farm implements repeatedly pass through the soil at the same depth. This causes soil particles to be pressed closer together, reducing the amount of pore space and the size of the pores. Consequently, these pans have permeability rates lower than those of the soil above and below them.
- Natural hardpans: Can form when certain minerals, such as iron, lime (calcium carbonate), and silica, bind to soil particles and create a cemented layer in the soil
- On a field scale, growers may choose to plow or rip a soil to break up natural or tillage pans and to increase the pore space in the soil. Another option is to use deep-rooted cover crops (see Unit 1.6, Selecting and Using Cover Crops). In a gardening context, growers can use double digging (see Unit 1. 2).
However, the benefits of using tillage to break up soil compaction are temporary, especially in coarser soils. In a coarse-textured soil, such as a sandy loam, most of the pore space added by plowing or ripping will be lost by the end of one cropping season. While it is more difficult to break up compaction in a finer textured soil, the benefits will last longer than they will in a coarse textured soil.

iii. Strongly contrasting textures

If the area of cultivation is very different from the surrounding soil, water or roots can be trapped in the cultivated area. This makes it similar to having a flower pot holding the water in or inhibiting root growth (sometimes called the "pot effect"), and can be potentially damaging to the crop. On a small scale, this can happen if a hole dug for planting is filled with soil amendments and the lighter soil, but not mixed well into the surrounding soil. On a larger scale, this can happen with sandy floodplain soils adjacent to denser soils.

iv. Water tables

8. Soil temperature

Soil temperature is important to growers, especially for spring planting. Many seeds need a certain minimum temperature for germination (see Unit 1.3, Propagating Crops from Seed, and Greenhouse Management).

a) Factors influencing soil temperature

- i. Local climate: Soil temperature is highly correlated to air temperature

- ii. Slope steepness and aspect: In the Northern Hemisphere, north-facing aspects tend to be cooler than south-facing aspects. The effect is more pronounced with steeper slopes and lower relative humidity.
 - iii. Topography: Topography strongly influences microclimates. For example, cool air flows down from mountaintops along drainages and settles in low parts of valleys. Soil and air temperature in these drainages and low areas may be lower than the elevated areas adjacent to them. This is readily apparent in the “citrus belt” in the San Joaquin Valley.
 - iv. Cover: Plants shade the soil, reducing the temperature. In addition, growing plants cool the surrounding air temperature through transpiration.
 - v. Soil color: Dark-colored soils absorb heat more readily than light-colored soils
 - vi. Horticultural practices: Mulching reduces heat by reducing insolation—the absorption of heat when it’s sunny—and can also act as an insulator, holding in heat in cold weather
- b) Soil temperature influences on soil properties
- i. Biological activity: Lower temperature = lower biological activity. Below about 40°F there is little biological activity.
 - ii. Organic matter accumulation: Lower temperature = higher organic matter accumulation (see “Relationship to climate” under “Organic matter,” above)
 - iii. Weathering of parent materials: Fluctuating temperatures help the physical breaking down of rock and mineral grains (the rock part of sand, silt, and clay). Warmer temperatures = higher rates of chemical weathering.
 - iv. Nutrient availability: Many nutrients are unavailable or poorly available at low temperatures, especially phosphorus. This is primarily related to low biological activity at those temperatures.

9. Drainage

Soil drainage is a way of expressing the frequency and duration of periods in which the soil is saturated (has free water or water in excess of field capacity). Excess free water in the root zone can kill plants or keep them from becoming established.

- a) Drainage classes: The U.S. Department of Agriculture recognizes seven natural drainage classes ranging from “excessively drained,” where the water moves out of the soil very rapidly, to “very poorly drained,” where water moves out of the soil so slowly that water remains at or near the soil surface through much of the growing season
- b) Factors that affect drainage
- i. Soil texture (coarser soils tend to drain more rapidly)
 - ii. Soil depth (shallow soils tend to drain more rapidly)
 - iii. Precipitation (areas with greater rainfall may drain more slowly)
 - iv. Topography (soils on level ground may drain more slowly)

10. Odor

a) Indicator of wetness

When soils are waterlogged, bacteria obtain oxygen for respiration from other compounds, including sulfate (SO_4^{-2}). This releases hydrogen sulfide gas, which has a “rotten eggs” odor. This accounts for the sulfur smell prevalent around some marshes, but can be smelled even in overwatered potted plants.

11. Permeability and infiltration

- a) Rate at which water moves through the soil

Permeability is the rate at which water moves down through the soil. It is usually measured in inches per hour. Infiltration is the rate at which water enters the soil. It is similar to permeability, except that it also takes into account surface conditions such as soil crusting. Permeability and infiltration affect the rate at which you can safely apply water to the field or garden bed. Applying water at rates higher than the permeability and infiltration can break apart soil aggregates and lead to sealing of the soil surface with the smaller particles (crusting). The soil sealing further decreases infiltration rates. Applying water at rates greater than the soil can take it in can also cause ponding, which increases the possibility of diseases, as well as runoff, which causes soil erosion and possible fertilizer loss.

The permeability of a soil can be no faster than the permeability of the slowest layer. For example, sandy loam has a permeability of 2.0 to 6.0 inches per hour. Sandy clay loam has a permeability of 0.2 to 0.6 inches per hour. A soil that has a sandy loam surface over a sandy clay loam subsoil will have a permeability of 0.2 to 0.6 inches per hour.

b) Measurement

Permeability is normally measured in inches per hour

c) Properties influencing permeability and infiltration

i. Texture

Soil texture is usually the dominant soil property affecting infiltration. Soils that are high in clay content tend to have a lower permeability, while soils that are high in sand content tend to have a higher permeability (see ► Table 2.7, Soil Permeability Chart).

► **TABLE 2.7** | SOIL PERMEABILITY CHART

THESE ARE NORMAL VALUES FOR NON-COMPACTED SOILS, SUCH AS IN GRASSLAND SITUATIONS

TEXTURE CLASS	TEXTURE	PERMEABILITY RATE	PERMEABILITY CLASS
Coarse	gravel, coarse sand	> 20 inches/hour	very rapid
	sand, loamy sand	6 – 20 inches/hour	rapid
Moderately Coarse	coarse sandy loam sandy loam fine sandy loam	2 – 6 inches/hour	moderately rapid
Medium	very fine sandy loam loam silt loam silt	0.60 – 2 inches/hour	moderate
Moderately fine	clay loam sandy clay loam silty clay loam	0.20 – 0.60 inches/hour	moderately slow
Fine	sandy clay silty clay clay (<60%)	0.06 – 0.20 inches/hour	slow
Very fine	clay (>60%) clay pan	< 0.06 inches/hour	very slow

Soil texture not only affects how fast water moves through the soil, it also affects the pattern of movement. Water will move almost straight down through a sandy soil whereas it will have more lateral movement in a soil with higher clay content. (See ◀ Figure 2.5, Movement of Water through Sandy and Clay Soils)

◀ **FIGURE 2.5** | MOVEMENT OF WATER THROUGH SANDY AND CLAY SOILS

m = minutes, hr = hours

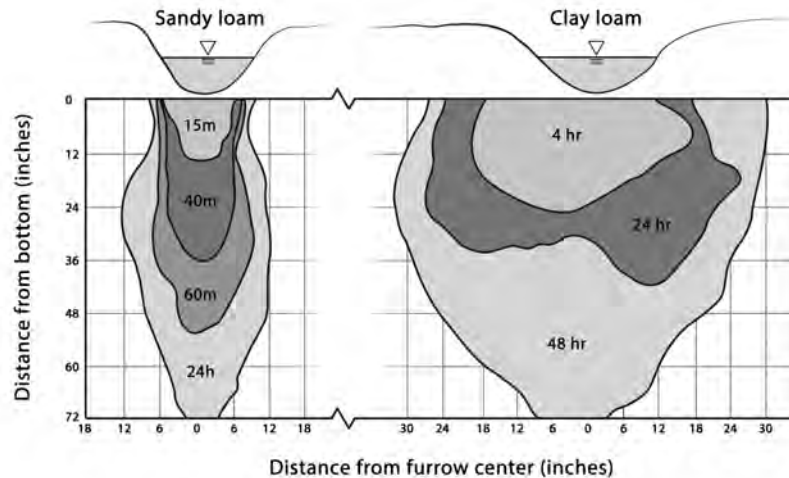

Illustration by José Miguel Mayo

ii. Structure

Soil structure has perhaps the greatest effect on permeability, especially as it relates to pores between soil particles. As we saw earlier, these pores allow for the movement of air and water through the soil.

Practices that improve soil structure also improve permeability. For example, heavy overhead irrigation or flood irrigation breaks down soil structure, which can lead to a sealing of the soil surface. This in turn makes it more difficult for any further water to enter the soil. Tillage can help break up a soil that has become sealed, particularly if it is done when the soil is not too wet (see Unit 1.2).

Other properties that relate to soil structure, permeability, and infiltration include:

- Salts: Sodium salts cause soil particles to disperse and clog pores, which has a negative effect on soil structure. Such soils tend to seal when wet, which drastically lowers both infiltration and permeability.
- Organic matter: As described above, organic matter improves soil structure, improving permeability and infiltration
- Compaction and pores: Fine-textured soils (soils with high clay content) contain more total pore space than coarse-textured soils (soils with high sand content), however the pore spaces are smaller. Because of this, water moves more slowly through a fine-textured soil, leading to lower permeability and infiltration.
- Calcium: Calcium improves soil structure by encouraging aggregation and increasing pore size. As a result it increases permeability and infiltration.
- Soil organisms: Microorganisms (e.g., bacteria and fungi) and macroorganisms (e.g., insects and earthworms) in the soil increase permeability and infiltration by encouraging the formation of soil aggregates and creating macropores in the soil

d) Additional properties influencing infiltration

- i. Dryness: Frequently, dry soils will repel water until they become moistened to some degree. This is especially true of soils that have high amounts of organic matter.

(See Peat Moss Demonstration in Supplemental Demonstrations and Examples.)

ii. Slope: Slope may cause water to run off rather than enter the soil

12. Water holding capacity

- a) Water holding capacity: The maximum amount of water that the soil can hold that is available for plant growth. It is the difference between the amount of water in the soil at field capacity and the amount of water in the soil at wilting point. It is also referred to as Available Water Capacity (AWC) and as Plant Available Water (PAW). These ideas are further discussed in Unit 1.5, Irrigation—Principles and Practices. **(See Sponge Demonstration in Supplemental Demonstrations and Examples)**
- b) Field capacity: The amount of water the soil can hold against the flow of gravity, that is, the water left after saturated soil has finished draining. This is the upper limit of water storage.
- c) Wilting point: The soil moisture content at which the soil can no longer provide moisture for growth of most agronomic plants. This is the lower practical limit of water storage and results in non-recoverable wilting of the crop. The permanent wilting point varies by crop.
- d) Measurement
 Water holding capacity is measured in inches/foot or inches/inch. If it takes the addition of two inches of water to wet a dry soil (at permanent wilting point) to a depth of 1 foot, then the water holding capacity is 2 inches per foot (0.16 inches per inch). The water holding capacity is then expanded to the number of inches of water the soil can hold within the rooting depth of the crop—usually ranging from 4–60 inches—or up to a root-restricting layer, whichever is shallower. Researchers generally use the metric system, and for water holding capacity this means m³/m³.
- e) Properties influencing water holding capacity
 - i. Texture
 Soils that have a high sand content tend to have a lower water holding capacity, while soils high in clay content tend to have a higher water holding capacity (see examples in ► Table 2.8, Typical Available Water Capacity). However, if the clay content is too high or the clay particles are too fine, then the water holding capacity may be reduced because the tiny pores between the particles may hold the water so tightly that the plants can't access it.

► **TABLE 2.8** | TYPICAL AVAILABLE WATER CAPACITY (AWC) FOR VARIOUS SOIL TEXTURES FOR SOILS HIGH IN 2:1 MINERALS (SOILS HIGH IN KAOLINITE OR GIBBSITE ARE ABOUT 20% LOWER)

SOIL TEXTURE	AVAILABLE MOISTURE	
	RANGE inches/foot	AVERAGE inches/foot
Very Coarse to Coarse Textured (sands and loamy sands)	0.50 – 1.25	0.90
Moderately Coarse Textured (coarse sandy loam, sandy loam and fine sandy loam)	1.25 – 1.75	1.50
Medium Textured (very fine sandy loam, silt, silt loam, loam, sandy clay loam, clay loam and silty clay loam)	1.50 – 2.30	1.90
Fine and Very Fine Textured (silty clay, sandy clay and clay)	1.60 – 2.50	2.10
Organic Soils (peats and mucks)	2.00 – 3.00	2.50

ii. Structure

Key factors influencing the structural effects on water holding capacity include:

- Organic matter: Organic matter improves the water holding capacity
- Compaction: A compacted soil has reduced pore space and thus less space for the water to occupy
- Soil depth: The presence of a root-restricting layer reduces the water holding capacity. In addition, the natural rooting depth of a plant limits the water available to it, and this varies by crop. If a crop's roots will only go to a depth of two feet in a well-cultivated soil with no root restrictions, then soil below two feet should not be considered when determining water holding capacity for that crop.
- Coarse fragments: "Coarse fragments" refers to gravel, cobbles, stones, and boulders in the soil—anything larger than 2 mm. Since coarse fragments do not hold water, their presence in the soil reduces its water holding capacity (see ► Table 2.9, Reduction in Water Holding Capacity for Coarse Fragments).

► **TABLE 2.9** | REDUCTION IN WATER HOLDING CAPACITY FOR COARSE FRAGMENTS

TEXTURE MODIFIER	% COARSE FRAGMENTS	% AWC REDUCTION
No modifier	0-15%	0-15%
Gravelly, cobbly, stony, bouldery	15-35%	15-35%
Very (gravelly, cobbly, stony, bouldery)	35-60%	35-60%
Extremely (gravelly, cobbly, stony, bouldery)	60-90%	60-90%

iii. Salts

Salts reduce the soil's water holding capacity. A soil that is salty can be wet and yet not have any water available for plant growth. This is because the salts have such a strong attraction for the water that the roots cannot overcome it (see ► Table 2.10, Reduction in AWC for Salts).

► **TABLE 2.10** | REDUCTION IN AWC FOR SALTS

EC of soil	4	6	12	16	18	20	22	25	30
% Reduction AWC	10	20	30	40	50	60	70	80	90

iv. Estimating total available water

You can estimate approximate total available water by hand using the methods in
 ▼ Example 1, Calculation of Total Available Water Capacity in the Root Zone.

You can obtain a more precise estimate by using soil moisture sensors to monitor the wetting and dry-down of the soil following irrigation events or precipitation. This requires electronic sensors that are installed at several depths within the rooting zone for a given crop at several locations in a field, the total number of which would depend on the budget available. While these methods have in the past been used primarily by researchers, some commercial growers are moving to this kind of monitoring to better understand the water holding capacity and total available water for their fields and crops, leading to more precise watering. This is of particular importance for areas that experience regular or periodic droughts or water rationing. As technology improves and prices of electronic monitoring come down, these methods are becoming available to more growers; see Supplement 3, Soil Moisture Sensing Instruments Commonly Used for Irrigation Schedules, in Unit 1.5.

▼ **EXAMPLE 1** | CALCULATION OF TOTAL AVAILABLE WATER CAPACITY IN THE ROOT ZONE

ESTIMATING AVAILABLE WATER CAPACITY

Determine AWC for each layer soil texture.

Reduce AWC for each layer for gravel.

Reduce AWC for each layer for salts.

Calculate AWC for entire soil.

(In this example we assume no salts or coarse fragments)

DEPTH	TEXTURE	LAYER THICKNESS (FOOT)		AWC PER FOOT (INCHES/FOOT)	=	AVAILABLE MOISTURE (INCHES)
0 to 8 inches	sandy loam	8/12	x	1.5	=	1.0
8 to 20 inches	sandy clay loam	12/12	x	1.9	=	1.9
20 to 48 inches	loamy sand	28/12	x	0.9	=	2.1
48 inches	rock (rooting depth)					
TOTAL AVAILABLE MOISTURE						5.0 inches

If you wanted to irrigate at 50% depletion, which is often the case, then in this case you would irrigate with 2.5 inches of water when the available water reached 2.5 inches (50% of 5 inches)

Demonstration 1: Soil Texture Determination

for the instructor

INSTRUCTOR OVERVIEW

The following demonstration outline covers the resources and skills used to determine the texture of a given soil sample by feel and to determine the approximate percentages of sand, silt, and clay in that sample. First demonstrate how to use the Soil Texture Decision Chart to identify the texture of a given sample. Following this, give students the opportunity to identify the approximate soil textural classification of several additional soil samples. The Soil Texture Triangle is used to help students determine the approximate percent of sand, silt, and clay in their samples. The Soil Texture Descriptions are included to help confirm the accuracy of the determination by providing descriptions of how the soil feels and performs under several tests.

MATERIALS

- Multiple samples of different kinds of soil textures
- Handouts (see below)
 1. The Soil Texture Decision Chart: How soil texture is determined
 2. The Soil Texture Triangle: The percentages of sand, silt, and clay in each textural classification
 3. The Soil Texture Descriptions: How the soil feels and performs under several tests

DEMONSTRATION TIME

About 1 hour

DEMONSTRATION OUTLINE

- A. Demonstrate how to determine the soil texture of a given sample by feel using the Soil Texture Decision Chart (next page)
- B. Determine the percentage of sand, silt, and clay in the soil sample using the Soil Texture Triangle (page 2-25)
- C. Use the Soil Texture Descriptions (pages 2-26–27) to confirm the accuracy of the textural determination
- D. Students practice determining soil texture following the same steps
- E. Once a texture has been determined, describe/discuss the characteristics of each of the soils:
 1. Drainage
 2. Water availability
 3. Cation exchange capacity (CEC)
 4. How it may be improved using organic farming practices

Soil Texture Decision Chart

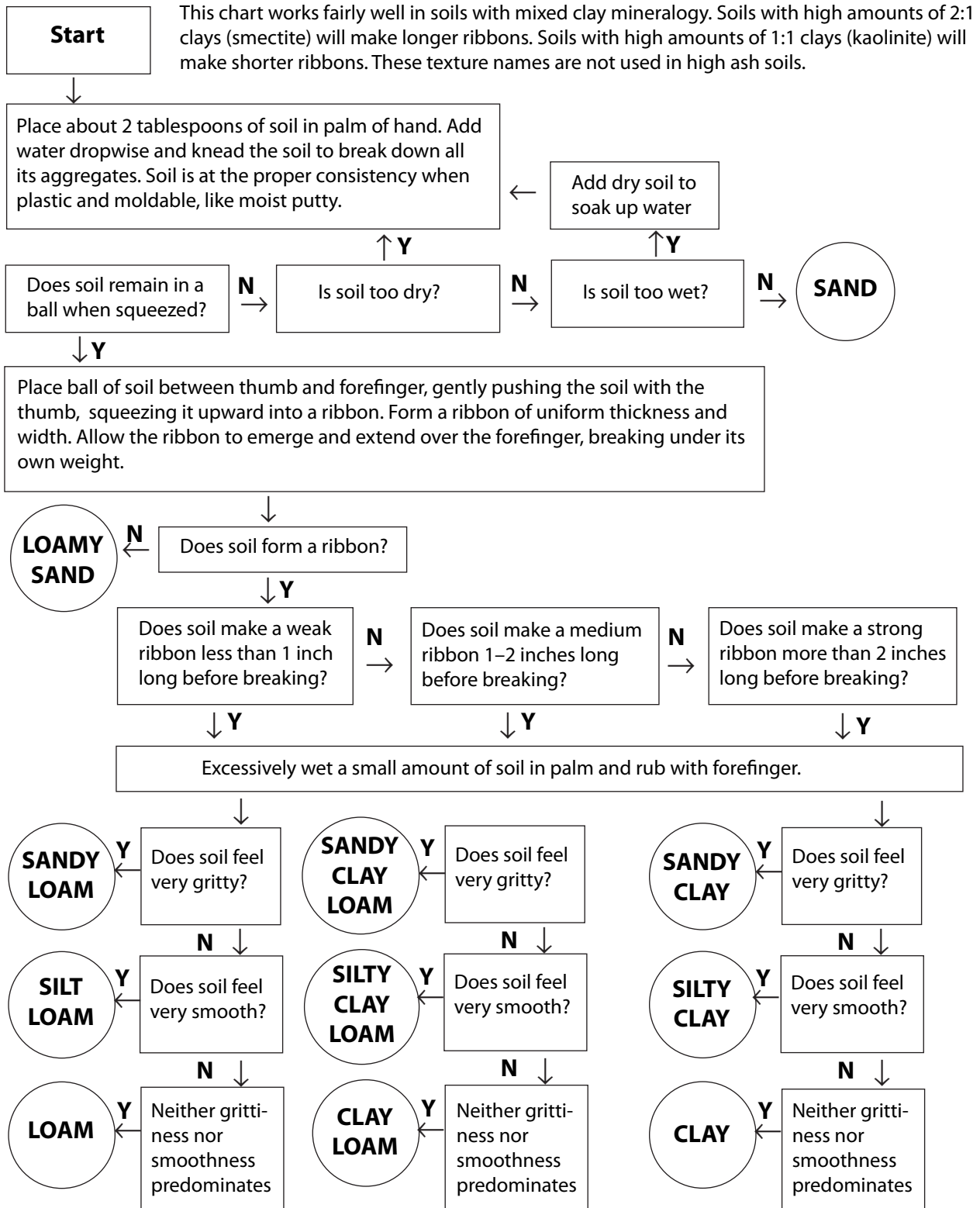

Soil Texture Triangle

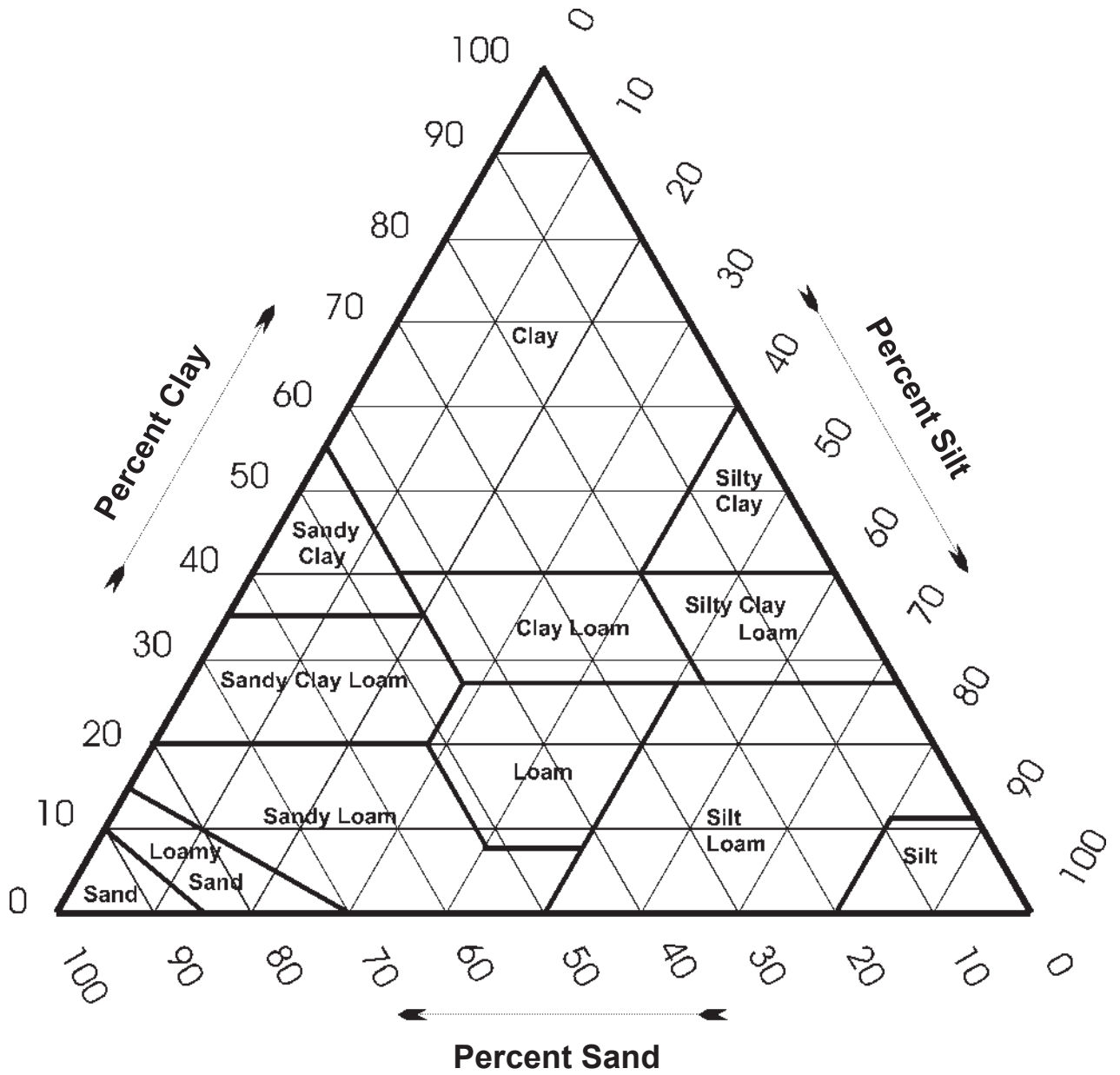

Soil Texture Descriptions

Edd Russell, Soil Scientist, USDA, Natural Resources Conservation Service

The mineral particles in the soil are divided into the following size classes:

Coarse fragments (gravel, cobbles, stones)	larger than 2 mm
Sand	0.05 to 2 mm
Silt	0.002 to 0.05 mm
Clay	smaller than 0.002 mm

To put these in perspective, if a particle of clay were the size of a BB, then a particle of silt would be about the size of a golf ball, and a grain of sand would be about the size of a chair.

Sand is gritty when wet or dry. Sands are the smallest soil particles you can see with the naked eye. Silt is smooth and floury when dry and feels greasy when wet. Clay is hard when dry and it is sticky and plastic when wet. Clay exhibits both cohesion (it sticks to itself) and adhesion (it sticks to other things).

Texture is a word used to describe how something feels. Soil texture refers to the relative proportion of sand, silt, and clay in a specific soil or horizon (layer) in the soil, because this determines how a soil feels. The texture class of a soil is determined with the texture triangle, shown on page 2-25.

Following is a description of some of the texture classes. There is also a chart at the back of this section that shows you how to determine soil texture.

SAND

Sand is loose and single grained. The individual grains can readily be seen and felt. Squeezed in the hand when dry, it will fall apart when the pressure is released. Squeezed when moist, it will form a cast (a mass that holds together), but will crumble when touched.

LOAMY SAND

When dry, loamy sand is loose and single grained. When wet it is gritty, it does not ribbon and lacks stickiness, but it may show faint clay stainings. Squeezed when moist, it forms a cast that does not break with very careful handling. Individual grains of sand can be readily seen or felt.

SANDY LOAM

A sandy loam soil forms weak aggregates, it contains 45%–85% sand, but has enough silt and up to 20% clay, which makes it somewhat coherent. Individual sand grains can be seen and felt. Squeezed when dry it will form a cast that will readily fall apart, but when moist it will form a cast that will bear careful handling without breaking. It will definitely stain fingers. When placed in water it turns the water cloudy.

LOAM

Loam is a soil having a relatively even mixture of different grades of sand, silt, and clay. It is mellow with a somewhat gritty feel, yet fairly smooth and slightly sticky and slightly plastic. Dry aggregates are slightly hard or hard to break. When moist it will form a cast that can be handled without breaking. It stains fingers. When placed in water it turns the water cloudy.

SILT LOAM

A silt loam is a soil having moderate amounts of the fine grades of sand and less than 27% clay; over half of the particles are silt sized. When dry, aggregates break with some difficulty. When moist it forms a firm ball and ribbons fairly well. Either dry or moist it will form casts that can be freely handled without breaking.

SILT

Silt is a rare textural class that is not easy to find in nature. Silt feels quite floury and soft when dry. When moist it is greasy feeling and is neither sticky nor plastic.

SANDY CLAY LOAM

A sandy clay loam is a soil with 45%–80% sand, 20%–35% clay, and 0%–28% silt. Dry aggregates are hard and break with difficulty. When moist it forms a firm ball and can be squeezed into a ribbon and may show a fingerprint. It is sticky and plastic; it stains fingers and it turns water cloudy.

CLAY LOAM

A clay loam is a moderately fine-textured soil that usually breaks into aggregates or lumps that are hard when dry and friable or firm when moist. The soil ribbons well when moist and shows a good fingerprint; is sticky and plastic and will form a cast that can bear much handling. It stains fingers.

SILTY CLAY LOAM

A silty clay loam handles like silt loam but it is sticky, plastic, and friable or firm when moist. Also, when moist the soil shows a good fingerprint and, like clay loam, will form a cast that can bear good handling. It stains fingers. When the soil is pulverized, it feels floury.

SANDY CLAY

A sandy clay is a fine texture soil with 45%–65% sand, 35%–55% clay and 0%–20% silt. Dry, it is very hard—aggregates can only be broken with extreme pressure. Moist, it is sticky or very sticky and plastic and shows a good fingerprint; it ribbons well and stains fingers.

SILTY CLAY

A silty clay soil is a fine-textured soil with 40%–60% silt, up to 20% sand and 40%–60% clay. Dry, it is extremely hard and it feels quite floury when crushed. It is very sticky and very plastic when moist and it shows a good fingerprint. It forms a cast that can bear much handling and ribbons very well, and clouds water and stains fingers.

CLAY

Clay is also a fine-textured soil that usually forms very hard or extremely hard blocks or prisms. It is very sticky and very plastic when moist, it ribbons very well and forms a very good fingerprint. Some clays are very firm or extremely firm when moist.

Demonstration 2: Soil Pit Examination

for the instructor

INSTRUCTOR OVERVIEW

In this demonstration, students examine the soil profile and various soil properties exposed in a shallow soil excavation. Discuss the soil profile and how the soil properties observed affect the use of the soil for farming, gardening, and other purposes.

MATERIALS

- Shovel and Pic mattock (to dig pit)
- Munsell soil color book
- Water bottle for moistening soil
- pH kit

SITE PREPARATION

Several hours before the demonstration dig a pit approximately 2–4 feet deep (or until distinct soil horizons are observed). For ease, the pit may be triangular in shape and stepped. Plan to have the soil profile in full sun at the time of the demonstration.

PREPARATION TIME

Approximately 1 hour

DEMONSTRATION TIME

1 hour

DEMONSTRATION OUTLINE

- A. Determine Approximate Textural Classification of Soil by Feel**
- B. Identify Distinct Soil Horizons**
 1. A Horizon and what defines it
 2. B Horizon and what defines it
 3. C Horizon and what defines it
 4. Identify indicators of soil disturbance (e.g., tillage)
- C. Describe/Define the Type(s) of Soil Structure Observed**
 1. Describe general soil structure and how it is created
 2. Identify and provide examples of soil aggregates and how they form

Supplemental Demonstrations & Examples

for the instructor

INSTRUCTOR OVERVIEW

These demonstrations and examples use analogy and models to illustrate various soil physical properties. Note the references to sections of the detailed lecture for specific topics.

SOIL EXAMPLES

Lecture Reference: Throughout

PURPOSE

To show examples of certain soil physical properties

MATERIALS: EXAMPLES OF SOIL TO SHOW

- Texture (sand, silt, clay, loam, etc.)
- Structure
- Hard pans
- Color (dark = high organic matter, bright = well drained, redoximorphic features = wetness)

BAKLAVA DEMONSTRATION

Lecture 2 Reference: A 1 a) iii

PURPOSE

To show layering akin to what is found in phyllosilicate (layer-lattice) clays

MATERIALS

- Baklava, preferably enough so that each student can have a piece

METHODS

Point out that many clay minerals are layered at the microscopic level much the way that baklava is and that cations are adsorbed to the sides of clay particles much the same as the nuts are stuck to the sides of the baklava.

TARGET DEMONSTRATION

Lecture 2 Reference: A 1 a) iii

PURPOSE

To show that clay is sticky (adhesion)

MATERIALS

- Moist clay, moistened enough so that it adheres to most surfaces
- A flipchart or blackboard with a target drawn on it
- Moist sandy loam (optional, for contrast)

METHODS

Form the clay into a ball, and throw it at the target (test the surface first to make sure that the clay will actually stick to it). Optionally, you can repeat the process with sandy loam or similar to show that it is not as sticky.

RIBBON DEMONSTRATION

Lecture 2 Reference: A 1 a) iii

PURPOSE

To show that clay is plastic (cohesion)

MATERIALS

- Moist clay
- Moist sandy loam (optional, for contrast)

METHODS

Squeeze the clay through your thumb and forefinger to create a ribbon. Optionally, repeat the process with sandy loam to show that it does not ribbon as well.

SLINKY DEMONSTRATION

Lecture 2 Reference: A 1 a) iii

PURPOSE

To show how clays shrink and swell by layers becoming separated

MATERIALS

- Slinky

METHODS

Stretch and compress a slinky in your hand while explaining that some clays can shrink and swell as layers get separated when water gets between them

◀ Figure 2.6

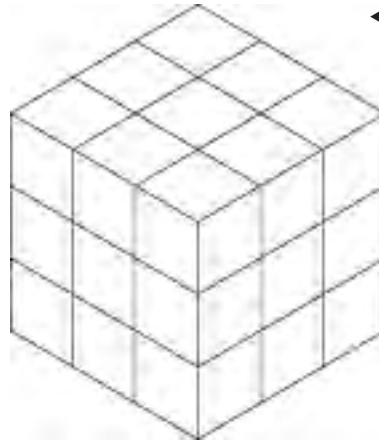

BLOCK DEMONSTRATION

Lecture 2 Reference: A 1 a) iii (See ◀ Figure 2.6)

PURPOSE

To show that smaller particles have a larger surface area than a single large particle occupying the same space.

MATERIALS

- 27 wooden blocks

METHODS

1. Form the blocks into a cube: 3 blocks by 3 blocks by 3 blocks. Assume the blocks each have a dimension of 1 on each side. Have the students calculate the surface area of the cube:

Each side is $3 \times 3 = 9$ There are 6 sides, $6 \times 9 = 54$
2. Have the students then calculate the total surface area of the individual blocks in the cube:

The side of each block has an area of $1 \times 1 = 1$
Each block has 6 sides, and therefore a surface area of $6 \times 1 = 6$
There are 27 blocks, so the total surface area is $6 \times 27 = 162$

COLOR BOOK EXAMPLE

Lecture 2 Reference: A 6 a)

PURPOSE

To show how soil color is described

MATERIALS

Munsell or Earth Colors soil color charts

METHODS

Show how the color charts and Munsell color notation are used.

PERMEABILITY DEMONSTRATION

Lecture 2 Reference: A 11 c) i (See ◀ Figure 2.7)

MATERIALS

- 4 jars or beakers, about 2 cup size
- 2 2-liter plastic soda bottles
- Coarse gravel, rounded is better, 1/2–1 inch, about 1 cup
- Fine gravel, < 1/4 inch, about 2 cups
- Sand, about 2 cups
- Clay, dry and ground, about 2 cups
- Water

METHODS

1. Cut the bottoms out of the soda bottles.
2. Invert the bottles into two of the jars to make funnels. Label one “Sand” and the other “Clay”.
3. Place the coarse gravel into the bottom of the funnels, enough to plug the holes so that the fine gravel won’t go through.
4. Cover the coarse gravel with about a 1 inch thick layer of fine gravel.
5. Place the sand and clay into the appropriate funnels. You want a layer about 2–3 inches thick.
6. Fill the other jars with about 3/4 to 1 cup of water each.
7. Using both hands, pour the water into the funnels at the same time and rate.
8. See which soil the water passes through faster.

◀ Figure 2.7, Permeability Demonstration

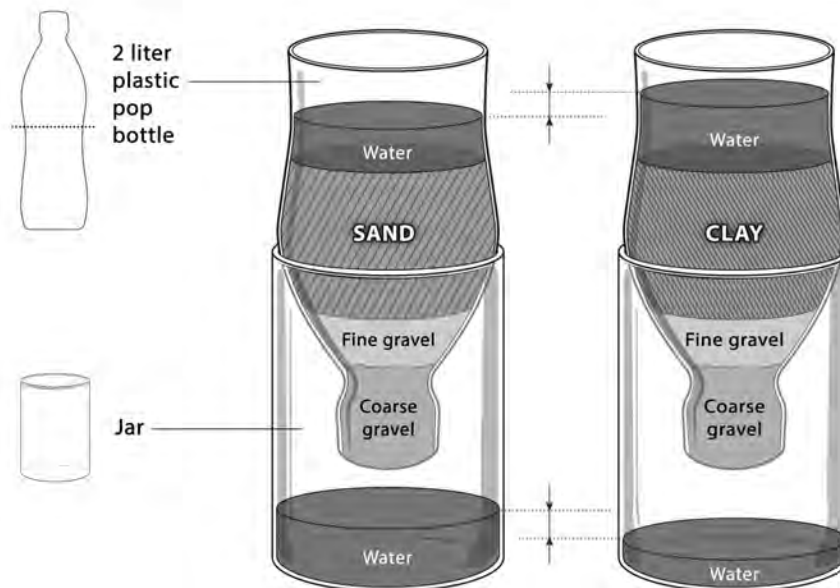

Illustration by José Miguel Mayo

PEAT MOSS DEMONSTRATION

Lecture 2 Reference: A 11 d) i.

PURPOSE

To show how dry organic matter repels water

MATERIALS

- Dry peat moss (a handful)
- Water

METHODS

Hold up a handful of dry peat moss and pour the water over it, showing how the water runs off rather than soaking in.

SPONGE DEMONSTRATION

Lecture 2 Reference: A 12

PURPOSE

To provide a conceptual model of available water capacity and field capacity

MATERIALS

- Sponge
- Water in a bowl or pan

METHODS

1. Soak the sponge in water until it is saturated.
2. Hold up the sponge until most of the water stops dripping. Explain that the sponge is analogous to soil. When the water has finished draining from the soil 24 hours after saturation, the soil is said to be at field capacity.
3. Squeeze the sponge to remove as much water as you can. Mention that this water would be analogous to what can be removed by plants and is the water available at the soil's water holding capacity. After squeezing the sponge, there is still some moisture left in it and that is analogous to the water that is held so tightly in the soil that plants cannot remove it, which is the water content at the permanent wilting point.

Assessment Questions

TRUE OR FALSE

1. Climate affects how a soil forms.
True False
2. Air is not an important part of soil.
True False
3. Clay holds more water than sand.
True False
4. Platy structure on the surface of the soil is desirable.
True False
5. Organic matter is not particularly beneficial to the physical condition of the soil.
True False

MULTIPLE CHOICE

1. Which of the following is not a soil-forming factor?
 - a. Time
 - b. Parent material
 - c. Soil color
 - d. Topography
2. Of the soil separates listed below, which has the smallest particle size?
 - a. Sand
 - b. Silt
 - c. Clay
3. Which one of the following is not considered one of the major constituents of soil?
 - a. Chemical
 - b. Mineral
 - c. Organic matter
 - d. Pore space

4. Which of the following foods has a structure similar to silicate clays?
 - a. Ice cream
 - b. Cheese
 - c. Cake
 - d. Baklava
5. A soil that has a balanced amount of sand, silt and clay has which one of the following for a texture?
 - a. Platy
 - b. Loam
 - c. Silt
 - d. Granular
6. Of the following, which is the best to add to a clay soil to help offset the negative effects of the clay?
 - a. Sand
 - b. Silt
 - c. Organic matter
 - d. Sodium salts
7. Which one of the following does not contribute to the formation of soil structure?
 - a. Biological factors
 - b. Amount and type of clay
 - c. Iron
 - d. Climate
8. Gray or mottled colors in the soil indicate past or present:
 - a. Wormholes
 - b. Wetness
 - c. Drought
 - d. Texture
9. The rate at which water moves through the soil is called:
 - a. Porosity
 - b. Hydraulic speed
 - c. Permeability
 - d. Saturation potential

10. Which of the following influence the available water-holding capacity of the soil?

- a. Texture
- b. Structure
- c. Organic matter
- d. Salts
- e. a, b and c
- f. a, b, c, and d
- g. a, c and d

ESSAY QUESTIONS

1. Why are the “empty” places in the soil so important?

2. Clay contributes many good characteristics to soil, but if there is too much it can cause problems. What are some of the negative effects of too much clay in the soil and how can these effects be overcome?

3. What are some of the negative effects of too much sand in the soil and how can these effects be overcome?

4. Use a soil texture triangle to calculate the soil texture for the following combinations of sand, silt and clay:

- a. 25% sand, 30% silt, 45% clay
- b. 40% sand, 30% silt, 30% clay
- c. 60% sand, 10% silt, 30% clay
- d. 70% sand, 12% silt, 18% clay
- e. 90% sand, 5% silt, 5% clay
- f. 80% sand, 15% silt, 5% clay
- g. 10% sand, 85% silt, 5% clay
- h. 5% sand, 75% silt, 20% clay
- i. 40% sand, 40% silt, 20% clay
- j. 55% sand, 5% silt, 40% clay
- k. 10% sand, 60% silt, 40% clay
- l. 5% sand, 45% silt, 50% clay

5. What surface structure is most desirable for gardening? What can you do to help develop this structure and maintain it?

Assessment Questions Key

TRUE – FALSE

1. Climate affects how a soil forms.
True *False*
2. Air is not an important part of soil.
True False
3. Clay holds more water than sand.
True *False*
4. Platy structure on the surface of the soil is desirable.
True False
5. Organic matter is not particularly beneficial to the physical condition of the soil.
True False

MULTIPLE CHOICE

1. Which of the following is not a soil-forming factor?
a. Time
b. Parent Material
c. Soil Color
d. Topography
2. Of the soil separates listed below, which has the smallest particle size?
a. Sand
b. Silt
c. Clay
3. Which one of the following is not considered one of the major constituents of soil?
a. Chemical
b. Mineral
c. Organic matter
d. Pore space
4. Which of the following foods has a structure similar to silicate clays?
a. Ice cream
b. Cheese
c. Cake
d. Baklava
5. A soil that has a balanced amount of sand, silt and clay has which one of the following for a texture?
a. Platy
b. Loam
c. Silt
d. Granular
6. Of the following, which is the best to add to a clay soil to help offset the negative effects of the clay?
a. Sand
b. Silt
c. Organic matter
d. Sodium salts
7. Which one of the following does not contribute to the formation of soil structure?
a. Biological factors
b. Amount and type of clay
c. Iron
d. Climate
8. Grey or mottled colors in the soil indicate past or present:
a. Wormholes
b. Wetness
c. Drought
d. Texture
9. The rate at which water moves through the soil is called:
a. Porosity
b. Hydraulic speed
c. Permeability
d. Saturation potential

10. Which of the following influence the available water-holding capacity of the soil?

- a. *Texture*
- b. *Structure*
- c. *Organic matter*
- d. *Salts*
- e. *a, b and c*
- f. *a, b, c, and d*
- g. **a, c, and d**

ADDITIONAL QUESTIONS

1. Why are the “empty” places in the soil so important?

- *Place for air and water to move and be stored*
- *Place for roots to grow*
- *Place for organisms to live*
- *Place for nutrients to be stored*

2. Clay contributes many good characteristics to soil, but if there is too much it can cause problems. What are some of the negative effects of too much clay in the soil and how can these effects be overcome?

Effects

- *Hard to work when wet*
- *Hard to work when dry*
- *Tendency to seal up when wetted*
- *Hard for roots to grow*

How to overcome

- *Only work soil when the moisture is right*
Add lots of organic matter, even coarse material
- *If irrigating, do so gently*

3. What are some of the negative effects of too much sand in the soil and how can these effects be overcome?

Effects

- *Droughty*
- *Low fertility*
- *Structure collapses easily*

How to overcome

- *Add lots of organic matter*
- *Don't till any more than necessary*

4. Use a soil texture triangle to calculate the soil texture for the following combinations of sand, silt and clay

- a. *25% sand, 30% silt, 45% clay*
clay
- b. *40% sand, 30% silt, 30% clay*
clay loam
- c. *60% sand, 10% silt, 30% clay*
sandy clay loam
- d. *70% sand, 12% silt, 18% clay*
sandy loam
- e. *90% sand, 5% silt, 5% clay*
sand
- f. *80% sand, 15% silt, 5% clay*
loamy sand
- g. *10% sand, 85% silt, 5% clay*
silt
- h. *5% sand, 75% silt, 20% clay*
silt loam
- i. *40% sand, 40% silt, 20% clay*
loam
- j. *55% sand, 5% silt, 40% clay*
sandy clay
- k. *10% sand, 60% silt, 40% clay*
silty clay loam
- l. *5% sand, 45% silt, 50% clay*
silty clay

5. What surface structure is most desirable for gardening? What can you do to help develop this structure and maintain it?

- *Granular or crumb structure is most desirable*
- *Add lots of organic materials and encourage biological activity*
- *Don't till the soil any more than necessary*
- *Only till under the proper moisture conditions*
- *Avoid compacting the soil with excessive traffic*
- *Rotate with a cover crop*
- *Use proper irrigation techniques*

Resources

PRINT RESOURCES

BOOKS

Brady, Niles, and Ray R. Weil. 2008. *The Nature and Properties of Soil, 14th edition*. Upper Saddle River, NJ: Prentice Hall.

Comprehensive (965 pages) textbook on soils—great for those who want to “go deeper” into the origins, classifications, and workings of soil. Used as a college text.

Buol, S. W., F. D. Hole, R. J. McCracken, and R. J. and Southard. 2011. *Soil Genesis and Classification, 6th Edition*. Ames, IA: Iowa State University Press.

College textbook used to teach soil classification.

Dixon, J. B., and S. B. Weed, eds. 1989. *Minerals in Soil Environments, 2nd Edition*. Madison, WI: Soil Science Society of America.

Very technical reference on soil minerals. Only the most hardy go here.

Dubbin, William. 2001. *Soils*. The Natural History Museum, London. Available from Iowa State University Press, Ames, Iowa.

Short overview of soil science. Easy to read and understand, lots of color photos.

Gershuny, Grace. 1993. *Start with the Soil*. Emmaus, PA: Rodale Press.

A general book on soils and soil management geared toward organic gardeners. Easy to read and understand.

Gershuny, Grace. 2000. *The Soul of Soil: A Soil-Building Guide for Master Gardeners and Farmers, Fourth Edition*. White River Junction, VT: Chelsea Green Publishing.

Provides essential information on soil ecosystem management for organic growers. Topics include organic matter management, building and maintaining humus, on-site composting, green manures and crop rotations, cultivation and weed control, nutrient balances and soil testing, and using mineral fertilizers.

Magdoff, Fred and Harold Van Es. 2010. *Building Soils for Better Crops, Third Edition*. Sustainable Agriculture Network, Handbook Series Book 4. Beltsville, MD: National Agricultural Library.

An introductory overview of organic management of soil fertility covering the basics of soil organic matter, physical and chemical properties of soil, ecological soil and crop management. Practical and accessible information. Available in print or to download from www.sare.org.

Schahczenski, Jeff, and Holly Hill. 2009. Agriculture, Climate Change, and Carbon Sequestration. ATTRA–National Sustainable Agriculture Information Service. IP 338. attra.ncat.org/publication.html

Provides an overview of the relationship between agriculture, climate change and carbon sequestration. Investigates possible options for farmers and ranchers to have a positive impact on the changing climate and presents opportunities for becoming involved in the emerging carbon market.

Stell, Elizabeth P., 1998. *Secrets to Great Soil*. Pownal, VT: Storey Communications, Inc.

An easy-to-read primer on soils, composting and basic gardening techniques. Includes numerous diagrams.

WEB-BASED RESOURCES

SOIL SURVEYS

Most of the Natural Resource Conservation Services' soil data information is now online. Soil surveys are also available at local NRCS offices and in many libraries.

U.S. Department of Agriculture, Natural Resources Conservation Service. Soil Surveys by State.

www.nrcs.usda.gov/wps/portal/nrcs/soilsurvey/soils/survey/state/

Provides links to soil surveys in each state, many of which are available as online PDFs.

U.S. Department of Agriculture, Natural Resources Conservation Service. *Web Soil Survey*.

websoilsurvey.nrcs.usda.gov/app/

The USDA's Web Soil Survey (WSS) provides soil data and information produced by the National Cooperative Soil Survey. You can use the site to create a custom soil resource report for your area of interest, view or print a soil map, and access data to help you determine the suitability of the soils for a particular use.

U.S. Department of Agriculture, Natural Resources Conservation Service. *National Soil Survey Handbook, Title 430-VI*. Available in libraries and online at:

www.nrcs.usda.gov/wps/portal/nrcs/detail/soils/survey/?cid=nrcs142p2_054242

Soil Survey Division Staff. 1993. *Soil Survey Manual*. United States Department of Agriculture, Washington DC., U.S. Government Printing Office.

www.nrcs.usda.gov/wps/portal/nrcs/detail/soils/ref/?cid=nrcs142p2_054262

This is the manual that soil scientists use to carry out soil survey work. The most definitive guide on how to describe the physical properties of soil. Available online at:

Soil Survey Staff. 1999. *Soil Taxonomy: A Basic System of Soil Classification for Making and Interpreting Soil Surveys, 2nd edition*. Natural Resources Conservation Service. United States Department of Agriculture Handbook 436. Available online at:

www.nrcs.usda.gov/wps/portal/nrcs/main/soils/survey/class/taxonomy/

The reference used to classify soils. Highly technical, used mainly by soil scientists. This publication can also be ordered from the NRCS Distribution Center:

nrcspad.sc.egov.usda.gov/DistributionCenter/

Enter the keywords "Soil Taxonomy, 2nd edition."

You can also order by contacting NRCS at their toll free number: 1-888-526-3227 or by email: NRCSDistributionCenter@ia.usda.gov

OTHER WEB-BASED RESOURCES

Australia's Soil Quality Group Fact Sheets

soilquality.org.au/factsheets/category/physical-indicators

Fact sheets provide clear explanations and illustrations of soil physical qualities, including soil texture, bulk density, and available water.

California Natural Resources Conservation Service (NRCS)

www.nrcs.usda.gov/wps/portal/nrcs/site/ca/home

Home page of the California NRCS, with information on drought assistance, conservation planning, technical resources, and much more.

Canadian Soil Information System

sis.agr.gc.ca/cansis/

Includes Canada's National Soils Database, soil survey reports and maps, and reference materials.

National Sustainable Agriculture Information Service: ATTRA

attra.ncat.org/soils.html

Lists sustainable agriculture publications related to soils and compost; many are available as PDFs.

North Carolina State University

courses.soil.ncsu.edu/resources/physics/texture/soilgeo.swf

NCSU offers a short animation on how the surface area of soil affects the size and shape of soil particles

Soil Science Society of America (SSA): Glossary of Soil Science Terms

www.soils.org/publications/soils-glossary

University of Arizona Cooperative Extension

extension.arizona.edu/sites/extension.arizona.edu/files/pubs/az1413.pdf

Describes the use of gypsum and other calcium amendments in southwestern soils to stabilize soil aggregates

University of Florida IFAS Extension

edis.ifas.ufl.edu/ae460

Includes a nice graphic of the relationships among plant available water (PAW), soil field capacity, permanent wilting point, soil unavailable water, and soil textural class, as well as information on using soil moisture sensors.

USDA Natural Resources Conservation Service,
Soils Website

www.nrcs.usda.gov/wps/portal/nrcs/site/soils/home/

Provides a “portal” to USDA NRCS resources, including surveys, publications, and educational opportunities.

USDA Natural Resources Conservation Service,
Munsell System of Color Notation

www.nrcs.usda.gov/wps/portal/nrcs/detail/soils/edu/?cid=nrcs142p2_054286

Describes the system used to classify soil color and the significance of soil color in understanding soil composition.

EDUCATION LINKS

soilsassociation.org/Links.htm

Educational links assembled by the United States Consortium of Soil Science Associations

VIDEOS & FILMS

How Water Moves through Soil. USDA Soil Conservation Service, Arizona Department of Agriculture. Irrigation Toolbox (34 minutes)

www.youtube.com/watch?v=Ph-7tQulbz4

Shows the movement of water through different soil types—great visuals

Symphony of the Soil, 2012. Directed by Deborah Koons Garcia (103 minutes)

www.symphonyofthesoil.com

An artistic and scientific exploration of soil, examining its complex dynamics as well as the human relationship with soil, the use and misuse of soil in agriculture, deforestation and development, and the latest scientific research on soil’s key role in ameliorating the most challenging environmental issues of our time. Filmed on four continents, featuring esteemed scientists and working farmers and ranchers.

INSTITUTIONS

Cooperative Extension Service or Farm Advisors office

Staff from these offices will be aware of crop nutrient needs and problems in your area. They can assist you with nutrient deficiency symptoms and known plant nutrition problems in your area.

US Department of Agriculture–Natural Resources Conservation Service (USDA–NRCS) field offices

Information about soils in your area can be obtained from NRCS field offices. They are usually listed in the U.S. Government pages of the phone book under US Department of Agriculture. They may also be listed as USDA Service Center. Some areas do not have NRCS offices but do have Resource Conservation District offices that can provide the same information.

Glossary

REFERENCES USED FOR TERMS

- 1 From the standard glossary used in soil survey reports
- 2 National Soil Survey Handbook. 1998. Available online at: www.nrcs.usda.gov/wps/portal/nrcs/detail/soils/survey/?cid=nrcs142p2_054242
- 3 Glossary of Soil Science Terms. Soil Science Society of America. Available online at www.soils.org/publications/soils-glossary
- 4 Merriam-Webster Online. www.m-w.com/

Absorption

*Uptake of matter or energy by a substance*³

Adsorption

*The process by which atoms, molecules, or ions are taken up from the soil solution or soil atmosphere and retained on the surfaces of solids by chemical or physical binding*³

Acidity

Refers to the condition of the soil when the exchange complex is dominated by hydrogen and aluminum ions

Acidity, salt-replaceable

*The aluminum and hydrogen that can be replaced from an acid soil by an unbuffered salt solution such as KCl or NaCl*³

Acidity, total

*The total acidity including residual and exchangeable acidity. Often it is calculated by subtraction of exchangeable bases from the cation exchange capacity determined by ammonium exchange at pH 7.0. It can be determined directly using pH buffer-salt mixtures (e.g., BaCl₂ plus triethanolamine, pH 8.0 or 8.2) and titrating the basicity neutralized after reaction with a soil.*³

Aeration, soil

*The exchange of air in soil with air from the atmosphere. The air in a well-aerated soil is similar to that in the atmosphere; the air in a poorly aerated soil is considerably higher in carbon dioxide and lower in oxygen.*¹

Aggregate, soil

*Many fine particles held in a single mass or cluster. Natural soil aggregates, such as granules, blocks, or prisms, are called peds. Clods are aggregates produced by tillage or logging.*¹

Alkali soil

*(i) A soil with a pH of 8.5 or higher or with a exchangeable sodium ratio greater than 0.15.
(ii) A soil that contains sufficient sodium to interfere with the growth of most crop plants.*³

Anion

*A negatively charged ion (has surplus electrons)*³

Anion exchange capacity

*The sum of exchangeable anions that a soil can adsorb. Usually expressed as centimoles, or millimoles, of charge per kilogram of soil (or of other adsorbing material such as clay).*³

Aspect

*The direction in which a slope faces*¹

Atom

*The smallest particle of an element that can exist either alone or in combination*⁴

Base saturation

*The degree to which material having cation-exchange properties is saturated with exchangeable bases (sum of Ca, Mg, Na, and K), expressed as a percentage of the total cation-exchange capacity*¹

Boulders

*Rock fragments larger than 2 feet (60 centimeters) in diameter*¹

Bulk density

*A measurement of the oven-dried weight of the less than 2 mm soil material per unit volume of soil. Common measurements are taken at a water tension of 1/10 bar; 1/3 bar; or 15 bar. Bulk density influences plant growth and engineering applications. It is used to convert measurements from a weight basis to a volume basis. Within a family particle size class, bulk density is an indicator of how well plant roots are able to extend into the soil. Bulk density is used to calculate porosity.*²

Calcareous soil

*A soil containing enough calcium carbonate (commonly combined with magnesium carbonate) to effervesce visibly when treated with cold, dilute hydrochloric acid*¹

Calcium carbonate equivalent

*The quantity of carbonate (CO₃) in the soil expressed as CaCO₃ and as a weight percentage of the less than 2 mm size fraction*²

Capillary water

*Water held as a film around soil particles and in tiny spaces between particles. Surface tension is the adhesive force that holds capillary water in the soil.*¹

Cation

*An ion carries a positive charge of electricity. The common soil cations are calcium, potassium, magnesium, sodium, and hydrogen.*¹

Cation-exchange capacity (CEC)

*The total amount of exchangeable cations that can be held by the soil, expressed in terms of milliequivalents per 100 grams of soil at neutrality (pH 7.0) or at some other stated pH value. The term, as applied to soils, is synonymous with base-exchange capacity but is more precise in meaning.*¹

CEC

See cation exchange capacity

Clay

*As a soil separate, the minerals soil particles less than 0.002 millimeter in diameter. As a soil textural class, soil material that is 40 percent or more clay, less than 45 percent sand, and less than 40 percent silt.*¹

Claypan

*A dense, compact, slowly permeable layer in the subsoil, with a much higher clay content than overlying materials from which is separated by a sharply defined boundary. A claypan is usually hard when dry, and plastic or sticky when wet.*²

Coarse fragments

See Rock fragments

Coarse textured soil

*Sand or loamy sand*¹

Cobble (or cobblestone)

*A rounded or partly rounded fragment of rock 3 to 10 inches (7.6 to 25 centimeters) in diameter*¹

Colloid

*A particle, which may be a molecular aggregate, with a diameter of 0.1 to 0.001 μm . Soil clays and soil organic matter are often called soil colloids because they have particle sizes that are within, or approach colloidal dimensions.*³

Compaction

*The process by which the soil grains are rearranged to decrease void space and bring them into closer contact with one another, thereby increasing the bulk density*³

Compound

*Something formed by a union of elements or parts; especially: a distinct substance formed by chemical union of two or more ingredients in definite proportion by weight*⁴

Consistence, soil

*Refers to the degree of cohesion and adhesion of soil material and its resistance to deformation when ruptured. Consistence includes resistance of soil material to rupture and to penetration; plasticity, toughness, and stickiness of puddled soil material; and the manner in which the soil material behaves when subject to compression. Terms describing consistence are defined in the Soil Survey Manual.*¹

Deep soil

See Depth

Depth, soil

*Generally, the thickness of the soil over bedrock. Very deep soils are more than 60 inches deep over bedrock; deep soils, 40 to 60 inches; moderately deep, 20 to 40 inches; shallow, 10 to 20 inches; and very shallow, less than 10 inches.*¹

Drainage class (natural)

*Refers to the frequency and duration of wet periods under conditions similar to those under which the soil formed. Alterations of the water regime by human activities, either through drainage or irrigation, are not a consideration unless they have significantly changed the morphology of the soil. Seven classes of natural soil drainage are recognized: excessively drained, somewhat excessively drained, well drained, moderately well drained, somewhat poorly drained, poorly drained, and very poorly drained. These classes are defined in the Soil Survey Manual.*¹

Duripan

*A subsurface soil horizon that is cemented by illuvial silica, usually opal or microcrystalline forms of silica, to the degree that less than 50 percent of the volume of air-dry fragments will slake in water or HCl*³

EC

See electrical conductivity

Edaphology

*The science that deals with the influence of soils on living things; particularly plants, including human uses of land for plant growth*³

Electrical conductivity (EC)

*The electrolytic conductivity of an extract from saturated soil paste*²

Element

*Basic unit of matter that can't be broken down by chemical means. They are the building blocks of nature. Any of more than 100 fundamental substances that consist of atoms of only one kind and that singly or in combination constitute all matter.*⁴

Eluviation

*The movement of material in true solution or colloidal suspension from one place to another within the soil. Soil horizons that have lost material through eluviation are eluvial; those that have received material are illuvial.*¹

Exchangeable anion

*A negatively charged ion held on or near the surface of a solid particle by a positive surface charge and which may be easily replaced by other negatively charged ions (e.g., with a Cl⁻ salt)*³

Fertility, soil

*The quality that enables a soil to provide plant nutrients, in adequate amounts and in proper balance, for the growth of specified plants when light, moisture, temperature, tillage, and other growth factors are favorable*¹

Field moisture capacity

*The moisture content of a soil, expressed as a percentage of the oven dry weight, after the gravitational, or free, water has drained away; the field moisture content 2 or 3 days after a soaking rain; also called normal field capacity, normal moisture capacity, or capillary capacity*¹

Fine textured soil

*Sandy clay, silty clay, or clay*¹

Fragments

*Unattached cemented pieces of bedrock, bedrock-like material, durinodes, concretions, and nodules 2 mm or larger in diameter; and woody material 20 mm or larger in organic soils*²

Genesis, soil

*The mode of origin of the soil. Refers especially to the processes or soil-forming factors responsible for the formation of the solum, or true soil, from the unconsolidated parent material.*¹

Gravel

*Rounded or angular fragments of rock as much as 3 inches (2 millimeters to 7.6 centimeters) in diameter. An individual piece is a pebble.*¹

Gravelly soil material

*Material that is 15 to 35 percent, by volume, rounded or angular rock fragments, not prominently flattened, as much as 3 inches (7.6 centimeters) in diameter*¹

Great group

*A group of soils that is characterized by common characteristics usually developed under the influence of environmental factors (as vegetation and climate) active over a considerable geographic range and that comprises one or more families of soil—called also great soil group.*⁴ See Soil Classification.

Gypsum

*The percent, by weight, of hydrated calcium sulfates in the <20 mm fraction of soil*²

Hardpan

*A hardened or cemented soil horizon, or layer. The soil material is sandy, loamy, or clayey and is cemented by iron oxide, silica, calcium carbonate, or other substance.*¹

Horizon, soil

A layer of soil, approximately parallel to the surface, having distinct characteristics produced by soil-forming processes. In the identification of soil horizons, an uppercase letter represents the major horizons. Numbers or lowercase letters that follow represent subdivisions of the major horizons. An explanation of the subdivisions is given in the Soil Survey Manual.

*The major horizons of mineral soil are as follows:*¹

O horizon = An organic layer of fresh and decaying plant residue.

A horizon = The mineral horizon at or near the surface in which an accumulation of humified organic matter is mixed with the mineral material. Also, a plowed surface horizon, most of which was originally part of a B horizon.

E horizon = The mineral horizon in which the main feature is loss of silicate clay, iron, aluminum, or some combination of these.

B horizon = The mineral horizon below an A horizon. The B horizon is in part a layer of transition from the overlying A to the underlying C horizon. The B horizon also has distinctive characteristics, such as (1) accumulation of clay, sesquioxides, humus, or a combination of these; (2) prismatic or blocky structure; (3) redder or browner colors than those in the A horizon; or (4) a combination of these.

C horizon = The mineral horizon or layer, excluding indurated bedrock, that is little affected by soil-forming processes and does not have the properties typical of the overlying soil material. The material of a C horizon may be either like or unlike that in which the solum formed. If the material is known to differ from that in the solum, an Arabic numeral, commonly a 2, precedes the letter C.

Cr horizon = Soft, consolidated bedrock beneath the soil.

R layer = Consolidated bedrock beneath the soil. The bedrock commonly underlies a C horizon, but it can be directly below an A or a B horizon.

Humus

*The well decomposed, more or less stable part of the organic matter in mineral soils*¹

Impervious soil

*A soil through which water, air, or roots penetrate slowly or not at all. No soil is absolutely impervious to air and water all the time.*¹

Infiltration

*The downward entry of water into the immediate surface of soil or other material, as contrasted with percolation, which is movement of water through soil layers or material*¹

Infiltration capacity

The maximum rate at which water can infiltrate into a soil under a given set of conditions

Infiltration rate

*The rate at which water penetrates the surface of the soil at any given instant, usually expressed in inches per hour. The rate can be limited by the infiltration capacity of the soil or the rate at which water is applied at the surface.*¹

Iron depletions

*Low-chroma zones having a low content of iron and manganese oxide because of chemical reduction and removal, but having a clay content similar to that of the adjacent matrix. A type of redoximorphic depletion.*¹

Leaching

*The removal of soluble material from soil or other material by percolating water*¹

Loam

*Soil material that is 7 to 27 percent clay particles, 28 to 50 percent silt particles, and less than 52 percent sand particles*¹

Loamy

*Texture group consisting of coarse sandy loam, sandy loam, fine sandy loam, very fine sandy loam, loam, silt loam, silt, clay loam, sandy clay loam, and silty clay loam soil textures*³

Medium textured soil

*Very fine sandy loam, loam, silt loam, or silt*¹

Microrelief

(i) Generically refers to local, slight irregularities in form and height of a land surface that are superimposed upon a larger landform, including such features as low mounds, swales, and shallow pits. See also gilgai, shrub-coppice dune, tree-tip mound, tree-tip pit.

*(ii) Slight variations in the height of a land surface that are too small to delineate on a topographic or soils map at commonly used map scales (e.g., 1:24 000 and 1:15 840)*³

Mineral soil

Soil that is mainly mineral material and low in organic material. Its bulk density is more than that of organic soil.¹

Moderately coarse textured soil

Coarse sandy loam, sandy loam, or fine sandy loam¹

Moderately deep soil

See Depth

Moderately fine textured soil

Clay loam, sandy clay loam, or silty clay loam¹

Molecule

The smallest particle of a substance that retains all the properties of the substance and is composed of one or more atoms⁴

Morphology, soil

The physical makeup of the soil, including the texture, structure, porosity, consistence, color, and other physical, mineral, and biological properties of the various horizons, and the thickness and arrangement of those horizons in the soil profile¹

Mottling, soil

Irregular spots of different colors that vary in number and size. Descriptive terms are as follows: abundance: few, common, and many; size: fine, medium, and coarse; and contrast: faint, distinct, and prominent. The size measurements are of the diameter along the greatest dimension. Fine indicates less than 5 millimeters (about 0.2 inch); medium, from 5 to 15 millimeters (about 0.2 to 0.6 inch); and coarse, more than 15 millimeters (about 0.6 inch).¹

Muck

Unconsolidated soil material consisting primarily of highly decomposed organic material in which the original plant parts are not recognizable (i.e., “sapric” in Soil Taxonomy). It generally contains more mineral matter and is usually darker in color, than peat.²

Munsell notation

A designation of color by degrees of three simple variables: hue, value, and chroma. For example, a notation of 10YR 6/4 is a color with hue of 10YR, value of 6, and chroma of 4.

Neutral soil

A soil having a pH value of 6.6 to 7.3 (see Reaction, soil)¹

Nutrient, plant

Any element taken in by a plant that is essential to its growth. Plant nutrients are mainly nitrogen, phosphorus, potassium, calcium, magnesium, sulfur, iron, manganese, copper, boron, and zinc obtained from the soil and carbon, hydrogen, and oxygen obtained from the air and water.¹

OM

See Organic matter

Order

The highest level (most general) of soil classification according to Soil Taxonomy. There are twelve orders: andisols, alfisols, aridisols, entisols, gelisols, histosols, inceptisols, mollisols, oxisols, spodosols, ultisols and vertisols.

Organic matter (OM)

Plant and animal residue in the soil in various stages of decomposition¹

Oxidation

The loss of one or more electrons by an ion or molecule³

Pan

A compact, dense layer in a soil that impedes the movement of water and the growth of roots. For example, hardpan, fragipan, claypan, plowpan, and traffic pan.¹

Parent material

The unconsolidated and more or less chemically weathered mineral or organic matter from which the solum is developed by pedogenic processes²

Peat

Unconsolidated soil material consisting largely of undecomposed, or slightly decomposed, organic matter (i.e., “fibric” in Soil Taxonomy) accumulated under conditions of excessive moisture²

Ped

An individual natural soil aggregate, such as a granule, a prism, or a block

Pedogenesis

See Genesis, soil

Pedology

Soil science, especially the study of soils as a natural body

Pedon

The smallest volume that can be called “a soil.” A pedon is three dimensional and large enough to permit study of all horizons. Its area ranges from about 10 to 100 square feet (1 square meter to 10 square meters), depending on the variability of the soil.¹

Percolation

The downward movement of water through the soil¹

Permeability

The quality of the soil that enables water or air to move downward through the profile. The rate at which a saturated soil transmits water is accepted as a measure of this quality. In soil physics, the rate is referred to as “saturated hydraulic conductivity,” which is defined in the NRCS Soil Survey Manual. In line with conventional usage in the engineering profession and with traditional usage in published soil surveys, this rate of flow continues to be expressed as “permeability.” Terms describing permeability, measured in inches per hour, are as follows:¹

Permeability class	rate per hour
Extremely slow	0.0 to 0.01 inch
Very slow	0.01 to 0.06 inch
Slow	0.06 to 0.2 inch
Moderately slow	0.2 to 0.6 inch
Moderate	0.6 inch to 2.0 inches
Moderately rapid	2.0 to 6.0 inches
Rapid	6.0 to 20 inches
Very rapid	more than 20 inches

pH value

A numerical designation of acidity and alkalinity in soil. (See Reaction, soil.)¹

Plowpan

A compacted layer formed in the soil directly below the plowed layer¹

Ponding

Standing water on soils in closed depressions. Unless the soils are artificially drained, the water can be removed only by percolation or evapotranspiration.¹

Potential rooting depth (effective rooting depth)

Depth to which roots could penetrate if the content of moisture in the soil were adequate. The soil has no properties restricting the penetration of roots to this depth.¹

Profile, soil

A vertical section of the soil extending through all its horizons and into the parent material¹

Reaction, soil

A measure of acidity or alkalinity of a soil, expressed in pH values. A soil that tests to pH 7.0 is described as precisely neutral in reaction because it is neither acid nor alkaline. The degrees of acidity or alkalinity, expressed as pH values, are:¹

Reaction class	pH
Ultra acid	less than 3.5
Extremely acid	3.5 to 4.4
Very strongly acid	4.5 to 5.0
Strongly acid	5.1 to 5.5
Moderately acid	5.6 to 6.0
Slightly acid	6.1 to 6.5
Neutral	6.6 to 7.3
Slightly alkaline	7.4 to 7.8
Moderately alkaline	7.9 to 8.4
Strongly alkaline	8.5 to 9.0
Very strongly alkaline	9.1 and higher

Redoximorphic concentrations

Nodules, concretions, soft masses, pore linings, and other features resulting from the accumulation of iron or manganese oxide. An indication of chemical reduction and oxidation resulting from saturation.¹

Redoximorphic depletions

Low-chroma zones from which iron and manganese oxide or a combination of iron and manganese oxide and clay has been removed. These zones are indications of the chemical reduction of iron resulting from saturation.¹

Redoximorphic features

Redoximorphic concentrations, redoximorphic depletions, reduced matrices, a positive reaction to alpha, alpha-dipyridyl, and other features indicating the chemical reduction and oxidation of iron and manganese compounds resulting from saturation.

Reduction

The gain of one or more electrons by an ion or molecule³

Relief

The relative difference in elevation between the upland summits and the lowlands or valleys of a given region³

Rock fragments

Rock or mineral fragments having a diameter of 2 millimeters or more; for example, gravel, cobbles, stones, and boulders¹

Root zone

The part of the soil that can be penetrated by plant roots¹

Runoff

The precipitation discharged into stream channels from an area. The water that flows off the surface of the land without sinking into the soil is called surface runoff. Water that enters the soil before reaching surface streams is called groundwater runoff or seepage flow from groundwater.¹

Saline soil

A nonsodic soil containing sufficient soluble salt to adversely affect the growth of most crop plants. The lower limit of saturation extract electrical conductivity of such soils is conventionally set at 4 dS/m (mmhos/cm) at 25°C. Actually, sensitive plants are affected at half this salinity and highly tolerant ones at about twice this salinity.³

Saline-sodic soil

A soil containing sufficient exchangeable sodium to interfere with the growth of most crop plants and containing appreciable quantities of soluble salts. The exchangeable sodium ratio is greater than 0.15, the conductivity of the soil solution, at saturated water content, of greater than 4 dS m (at 25°C), and the pH is usually 8.5 or less in the saturated soil.³

Salinity

A measure of the “saltiness” of the soil expressed as the electrical conductivity of a saturation extract in decisiemens per meter (dS/m=mmhos/cm) at 25°C.

The following salinity classes are recognized:²

Salinity class	mhos/cm
Non-saline	0 - 2
Very slightly saline	2 - 4
Slightly saline	4 - 8
Moderately saline	8 - 16
Strongly saline	> 16

Sand

As a soil separate, individual rock or mineral fragments from 0.05 millimeter to 2.0 millimeters in diameter. Most sand grains consist of quartz. As a soil textural class, a soil that is 85 percent or more sand and not more than 10 percent clay.¹

Sandy

Texture group consisting of sand and loamy sand textures.³

SAR

See sodium adsorption ratio

Saturation

Wetness characterized by zero or positive pressure of the soil water. Under conditions of saturation, the water will flow from the soil matrix into an unlined auger hole.¹

Series, soil

A group of soils that have profiles that are almost alike, except for differences in texture of the surface layer. All the soils of a series have horizons that are similar in composition, thickness, and arrangement (see soil classification).¹

Shallow soil

See Depth

Silica

A combination of silicon and oxygen. The mineral form is called quartz.¹

Silt

As a soil separate, individual mineral particles that range in diameter from the upper limit of clay (0.002 millimeter) to the lower limit of very fine sand (0.05 millimeter). As a soil textural class, soil that is 80 percent or more silt and less than 12 percent clay.¹

Slick spot

A small area of soil having a puddled, crusted, or smooth surface and an excess of exchangeable sodium. The soil generally is silty or clayey, is slippery when wet, and is low in productivity.¹

Slope

The inclination of the land surface from the horizontal. Percentage of slope is the vertical distance divided by horizontal distance, then multiplied by 100. Thus, a slope of 20 percent is a drop of 20 feet in 100 feet of horizontal distance.²

Slope aspect

The direction toward which the surface of the soil (or slope) faces²

Sodic (alkali) soil

A soil having so high a degree of alkalinity (pH 8.5 or higher) or so high a percentage of exchangeable sodium (15 percent or more of the total exchangeable bases), or both, that plant growth is restricted¹

Sodicity

The degree to which a soil is affected by exchangeable sodium.¹ See sodium adsorption ratio. The following categories are commonly used in California:

Sodicity	SAR
Slight	less than 13:1
Moderate	13-30:1
Strong	more than 30:1

Sodium adsorption ratio (SAR)

Sodium adsorption ratio (SAR) is a measure of the amount of sodium (Na) relative to calcium (Ca) and magnesium (Mg) in the water extract from saturated soil paste. It is the ratio of the Na concentration divided by the square root of one-half of the Ca + Mg concentration.² SAR is calculated from the equation:

$$\text{SAR} = \text{Na} / [(\text{Ca} + \text{Mg})/2]^{0.5}$$

Soil

A natural, three-dimensional body at the earth's surface. It is capable of supporting plants and has properties resulting from the integrated effect of climate and living matter acting on earthy parent material, as conditioned by relief over periods of time.¹

Soil classification

The systematic grouping of soils based on their characteristics. The system used in the United States is called Soil Taxonomy. Soil Taxonomy uses the following levels grouping (from most general to most specific): order, suborder, great group, subgroup, family and series.

Soil depth

See Depth, Soil

Soil separates

Mineral particles less than 2 millimeters in equivalent diameter and ranging between specified size limits. The names and sizes, in millimeters, of separates recognized in the United States are as follows:¹

Name	Size in mm
Very coarse sand	2.0 to 1.0
Coarse sand	1.0 to 0.5
Medium sand	0.5 to 0.25
Fine sand	0.25 to 0.10
Very fine sand	0.10 to 0.05
Silt	0.05 to 0.002
Clay	less than 0.002

Stones

Rock fragments 10 to 24 inches (25 to 60 centimeters) in diameter if rounded or 15 to 24 inches (38 to 60 centimeters) in length if flat¹

Stony

Refers to a soil containing stones in numbers that interfere with or prevent tillage¹

Structure, soil

The arrangement of primary soil particles into compound particles or aggregates. The principal forms of soil structure are: platy (laminated), prismatic (vertical axis of aggregates longer than horizontal), columnar (prisms with rounded tops), blocky (angular or subangular), and granular. Structureless soils are either single grained (each grain by itself, as in dune sand) or massive (the particles adhering without any regular cleavage, as in many hardpans).¹

Subgroup

See Soil Classification

Suborder

See Soil Classification

Subsoil

*Technically, the B horizon; roughly, the part of the solum below plow depth*¹

Surface layer

*The soil ordinarily moved in tillage, or its equivalent in uncultivated soil, ranging in depth from 4 to 10 inches (10 to 25 centimeters). Frequently designated as the “plow layer,” or the “Ap horizon.”*¹

Surface soil

*The A, E, AB, and EB horizons, considered collectively. It includes all subdivisions of these horizons.*¹

Texture, soil

*The relative proportions of sand, silt, and clay particles in a mass of soil. The basic textural classes, in order of increasing proportion of fine particles, are sand, loamy sand, sandy loam, loam, silt loam, silt, sandy clay loam, clay loam, silty clay loam, sandy clay, silty clay, and clay. The sand, loamy sand, and sandy loam classes may be further divided by specifying “coarse,” “fine,” or “very fine.”*¹

Tilth, soil

*The physical condition of the soil as related to tillage, seedbed preparation, seedling emergence, and root penetration*¹

Topsoil

The upper part of the soil, which is the most favorable material for plant growth. It is ordinarily rich in organic matter and is used to topdress roadbanks, lawns, and land affected by mining.

Very deep soil

See Depth

Very shallow soil

See Depth

Water holding capacity (or available water capacity or plant available water)

The volume of water that should be available to plants if the soil were at field capacity. It is commonly estimated as the amount of water held between field capacity and permanent wilting point, with corrections for salinity, fragments, and rooting depth. It is commonly expressed as inches of water per inch of soil.² The following classes are used in California, based on the water holding capacity of 60-inch depth (or depth to a limiting layer):

Water holding capacity class	Water holding capacity/ 60 inches or limiting layer
Very low	0 to 2.5
Low	2.5 to 5
Moderate	5 to 7.5
High	7.5 to 10
Very high	more than 10
<i>See available water capacity</i>	

Water table

*The upper surface of ground water or that level below which the soil is saturated by water. Also the top of an aquifer.*¹

Weathering

*All physical and chemical changes produced in rocks or other deposits at or near the earth’s surface by atmospheric agents. These changes result in disintegration and decomposition of the material.*¹

Soil Chemistry and Fertility

Introduction	51
Lecture 1: Basic Soil Chemistry Concepts and Nutrient Uptake	53
Lecture 2: Plant Nutrient Requirements and Nutrient Cycles	61
Demonstrations	75
Assessment Questions and Key	77
Resources	81

Introduction: Soil Chemistry & Fertility

UNIT OVERVIEW

This unit introduces students to basic concepts in soil chemistry, with an emphasis on how soil chemistry relates to the development and maintenance of soil fertility.

The unit begins with a review of basic chemistry concepts and terminology, including atoms, compounds, ions, and chemical reactions. Soil nutrients essential to plant growth and the processes involved in nutrient uptake are introduced, with particular attention paid to cation exchange capacity (CEC) and base saturation as they relate to soil fertility. Soil pH and its effects on nutrient availability are also covered.

Lecture 2 provides an overview of the biogeochemical cycles involved in making essential nutrients available to plants; the physiological role of essential plant nutrients; the characteristic symptoms of plant nutrient deficiencies; and the soil amendments used to supply limiting nutrients for organic farming systems.

MODES OF INSTRUCTION

- > LECTURE (2 LECTURES, 1.5–2.0 HOURS EACH)
Lecture 1 covers basic chemistry concepts and definitions relating to soil chemistry, in particular, nutrient uptake processes and plant nutrients.
In Lecture 2, the role of individual plant nutrients and nutrient cycling are discussed.
- > DEMONSTRATIONS
Five suggested demonstrations are designed to be integrated into the lecture. They provide visual representations and analogies for the concepts presented in the outline.
- > ASSESSMENT QUESTIONS (1.0 HOUR)
Assessment questions reinforce key unit concepts and skills.

LEARNING OBJECTIVES

CONCEPTS

- Basic chemistry concepts (atomic structure and atomic bonding) and terminology
- Principles and processes involved in cation exchange
- pH and its effects on nutrient availability
- Soil acidity
- Soil alkalinity
- Plant nutrients: What they are, their cycles and how they move through the soil, their use by plants, and the problems plants exhibit when deficient in nutrients

SKILLS

This material is primarily conceptual, providing background for the skill-based sessions in Part 1, Organic Farming and Gardening Skills

REQUIRED READINGS (SEE RESOURCES SECTION)

Gershuny, Grace. 1996. *Start With the Soil*, Chapter 5; Chapter 7, pages 163-173; Chapter 8, pages 187-195; Chapter 9, pages 200-205

Brady, Nyle C., and Ray R. Weil. 2008. *The Nature and Properties of Soils*, Chapter 1, 1.15-1.16; Chapter 16: 16.1-16.4; 16.12

RECOMMENDED READINGS

Stell, Elizabeth P. 1998. *Secrets to Great Soil*, Chapter 2; Chapter 6; Chapter 7, pp. 150-157

Parnes, Robert. 1990. *Fertile Soil: A Grower's Guide to Organic and Inorganic Fertilizers*, Chapter 2, pp. 9-19; Chapter 16 (micronutrients)

Lecture 1: Basic Soil Chemistry Concepts & Nutrient Uptake

Pre-Assessment Questions

1. What are the three most important plant nutrients? What are three other essential plant nutrients?
2. How do plants obtain nutrients from the soil?
3. What might happen if levels of one essential plant nutrient are very low or very high?
4. What is soil pH and why is it important to know the pH of your soil?
5. How does the organic matter content of the soil influence soil fertility?

A. Introduction to Basic Chemistry Concepts

1. Atoms and elements

Element: a basic unit of matter that can't be further simplified, such as oxygen or iron. Elements are the building blocks of nature. Each element is assigned a symbol of one or more letters, such as O for oxygen and Fe for iron.

Atom: the smallest part of an element that cannot be broken down by chemical means. Each atom is in turn made up of protons, neutrons, and electrons. Protons have positive electrical charges, electrons have negative charges, and neutrons have no charge. Protons and neutrons are in the center of the atom, comprising the nucleus, while electrons orbit the nucleus. Atoms have no net charge, so there are an equal number of protons and electrons, which is the atomic number. The number of neutrons varies, and is determined by subtracting the atomic number from the mass number (the atomic weight rounded up to the nearest whole number). The atomic weight for each element is given on the periodic table.

2. Compounds, molecules, and atomic bonds

Atoms combine to form molecules. A collection of like molecules that consist of two or more different kinds of elements is called a compound. Molecules are represented by using the symbols of the elements with subscripts to tell how many there are of each. For example, water is represented as H₂O, which means it has two hydrogen atoms and one oxygen atom.

One way that different atoms can join together is by sharing electrons. This is a type of chemical bond or atomic bond.

3. Ions

When there is an imbalance in the number of protons and electrons of an atom, the resulting atom or molecule is called an ion. Ions are commonly formed, for example, when a compound dissolves in water. A cation is a positively charged ion (missing electrons) and an anion is a negatively charged ion (has surplus electrons). The example below shows calcium carbonate (on the left) when it dissolves in water (on the right). The superscript numbers indicate the number of missing (+) or surplus (-) ions. If no number is given and there is just a + or - then there is an imbalance of only one (1) electron.

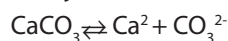

Where:

CaCO₃ = Calcium Carbonate

Ca²⁺ = Calcium (cation)

CO₃²⁻ = Carbonate (anion)

A molecule in solution is usually in equilibrium with its constituent ions. In other words, some molecules are breaking into ions while other ions are recombining to form molecules.

4. Elements needed by plants

a) From water and air

Carbon (C), Hydrogen (H), Oxygen (O)

b) From soil

Nitrogen (N), Phosphorus (P), Sulfur (S), Potassium (K), Calcium (Ca), Magnesium (Mg), Copper (Cu), Iron (Fe), Manganese (Mn), Zinc (Zn), Boron (B), Molybdenum (Mo), Cobalt (Co), Chlorine (Cl)

5. Chemical reactions

Chemical reactions occur when atoms are rearranged to form new molecules or compounds. For example, carbon dioxide and water can combine to form a sugar (as in photosynthesis). This reaction is written out like this:



(Note that since energy is required to make the reaction happen, this energy is released when the sugars are broken down. This energy-releasing equation is called respiration and is what happens in our bodies—and in some form in all organisms—all the time.)

Redox reactions are paired oxidation and reduction reactions that are very common and important in nature. Oxidation occurs when an element or molecule loses an electron, and reduction occurs when another element or molecule gains the electron. The electron donor is said to be oxidized and the electron acceptor is reduced. The “ox” in redox is used because it was first studied in aerobic environments, with oxygen as the element that accepts the electrons (and thus increases in quantity in the new molecule).

A common redox reaction occurs in the soil when ammonia is added: In the presence of oxygen, ammonia (NH_3) is oxidized to form nitric acid (HNO_3 , which now contains oxygen) and water

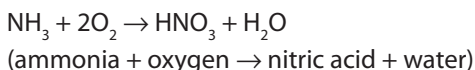

6. Adsorption vs. absorption

Adsorption and absorption are two similar soil science terms with almost opposite meanings

Adsorption means to be held onto the outside of something. In soils this refers to how ions are held to the outer surfaces of mineral and organic particles.

Absorption means to be taken up into something, such as water being taken up by a sponge or nutrients being taken into plant roots

Picture a life raft at sea: Absorbed would be the people in the life raft, adsorbed would be the people hanging to the outside of the life raft

7. Organic vs. organic

Organic is another term with multiple meanings. To the chemist, organic refers to many kinds of compounds containing carbon, which may be natural or synthetic (human-made). Many of the synthetic pesticides used are “organic” by this definition.

Organic also refers to agricultural practices based on maintaining soil fertility through organic matter. Such systems do not use synthetic organic chemicals. When growers or food processors abide by a particular set of U.S. Department of Agriculture regulations and their practices are confirmed for that site by a certifying agency, they legally may market their food as “organic.”

B. Soil Colloids

1. Definition

Colloid: A particle, either mineral or organic, with a diameter of 0.1 to 0.001 μm . Because of their small size, colloids go into suspension in a solution—they float around for great lengths of time without settling out. Clay particles and soil organic matter are common examples of soil colloids.

2. Importance

Colloids have properties that are important in soil chemistry. For example, because of their small size they have a high relative surface area that has a charge, so they can adsorb cations. This is key for Cation Exchange Capacity (see CEC, below), but also for maintaining the structure of the soil (binding particles together) and for its water-holding capacity (higher concentration of colloids means greater ability to hold water).

C. Soil Solution

1. Definition

Water in the soil is referred to as the soil solution because it contains dissolved materials (cations and ions) as well as suspended colloids of clay and organic matter

While plants tend to get their nutrients from the soil solution, the solution does not contain sufficient nutrients at any one time to last the life of the plant. Usually these nutrients are replenished from the pool of exchangeable nutrients (those that are adsorbed onto colloids; see CEC, below). Still more nutrients are held in what is called the stable pool (bound up in solid form as minerals or organic matter).

D. Cation Exchange Capacity (CEC) and Base Saturation

1. CEC

a) Definition

CEC is a measure of the ability of the soil to adsorb cations. Plants are primarily able to take up the ionic form of nutrients via their roots. Many of these nutrients are taken up as cations (remember, these are positive ions). Most soils have at least some ability to hold onto cations at negatively charged sites, called exchange sites, on soil particles.

(Demonstration: Use magnets to demonstrate attraction of positive to negative.)

The cations are held loosely to the edges (adsorbed) such that they can be easily replaced with similarly charged cations. The total amount of the cations that the soil can hold adsorb is the cation exchange capacity (CEC).

b) Measurement: CEC is measured as milliequivalents (meq) per 100g of soil or centimoles (cmol) per kg. These are actually two ways of expressing the same numbers.

c) Factors influencing CEC

i. Amount and type of clay

Higher amounts of clay in the soil (relative to sand and silt; see more at Unit 2.1, Soil Physical Properties) mean higher CEC. Certain kinds of clay (smectites, montmorillonite) have higher CEC than others (such as kaolinite).

ii. Amount of organic matter

Higher amounts of organic matter in the soil mean higher CEC

iii. pH-dependent CEC

Clay minerals and organic matter have a CEC that varies with pH. As pH increases, so do the number of negative charges on the clay or organic matter particles, and thus so does the CEC.

2. Base saturation

a) Definitions

Base saturation refers to the percentage of CEC sites that are occupied with bases (usually Ca^{2+} , Mg^{2+} , K^+ and Na^+) instead of ions that make the soil acidic (H^+ or Al^{3+}).

Base saturation is often expressed as a percent.

The term *exchangeable bases* usually refers to the Ca^{2+} , Mg^{2+} , K^+ and Na^+ adsorbed to CEC sites.

b) Significance

Soils with high base saturations are considered more fertile because many of the “bases” that contribute to it are plant nutrients. Usually the base saturation is 100 percent when the pH is above about 6.5. Since rainfall tends to leach bases out of the soil, areas with higher rainfall tend to have lower base saturations than areas with lower rainfall, unless the parent material is high in bases (such as limestone).

E. Anion Exchange Capacity (AEC)

1. Definition

While positively-charged cations adsorb to negatively-charged sites, the opposite is true for negatively-charged anions: They adsorb to sites with a positive charge. This is anion exchange capacity, AEC. Nutrients that are usually supplied by anions are nitrogen (as NO_3^-), phosphorus (as HPO_4^{2-}), sulfur (as SO_4^{2-}), chlorine (as Cl^-), boron (as $\text{B}_4\text{O}_7^{2-}$) and molybdenum (MoO_4^{2-}).

2. Measurement: Just like CEC (above), AEC is measured as milliequivalents (meq) per 100g of soil or centimoles (cmol) per kg.
3. pH-dependent AEC: Most clay particles only have negative exchange sites, so they have CEC in neutral and high pH conditions and sometimes AEC at low pH. Soil organic matter has both negative and positive exchange sites; it usually has CEC and may have AEC in very low pH (2 or lower) conditions. Most productive soils in the U.S. have pH well above the pH necessary for AEC, so this process plays a minor role in nutrient provision here. Highly weathered soils of the tropics are more likely to have AEC.
4. Nutrient leaching: Because there is generally little adsorption of anions, many (particularly nitrates) are easily leached down through the soil with rain or excess irrigation. This can lead to groundwater contamination, which can even happen in organic farming if the N is not well managed.

F. pH

1. What is pH?

pH stands for “potential of hydrogen” and it is expressed as the negative of the log of the concentration of hydrogen (H^+) ions. It is given as a number between 0 and 14. (Pure water is neutral with a pH of around 7.) In acidic soils ($\text{pH} < 7$), H^+ ions predominate. In alkaline soils ($\text{pH} > 7$), OH^- ions predominate. Soils with pH of 7 are neutral. **(Demonstrate different methods of measuring pH; see pH demonstration in Demonstrations.)**

► **TABLE 2.11** | SOIL REACTION AND pH

REACTION	pH	REACTION	pH
Ultra acid	< 3.5	Neutral	6.6 – 7.3
Extremely acid	3.5 – 4.4	Slightly alkaline	7.4 – 7.8
Very strongly acid	4.5 – 5.0	Moderately alkaline	7.9 – 8.4
Strongly acid	5.1 – 5.5	Strongly alkaline	8.5 – 9.0
Moderately acid	5.6 – 6.0	Very strongly alkaline	> 9.0
Slightly acid	6.1 – 6.5		

2. Effect of pH on nutrient availability and uptake (see ◀ Figure 2.8, Nutrient Availability at Different pH Values)

Although pH does not directly affect plants, it does affect the availability of different nutrients to plants. As we've seen in the CEC and AEC sections above, nutrients need to be dissolved in the soil solution before they can be accessed by plants. The soil pH changes whether a nutrient is dissolved in the soil solution or forms other less-soluble compounds (e.g., calcium compounds in high pH soils with high calcium carbonate concentrations), or if dissolved is then susceptible to leaching (e.g., nitrate).

3. pH and soil microbes

Soil microbes have reduced activity in low pH soils. This can cause them to take much longer to release necessary nutrients, such as N, P, and S, from organic matter.

G. Acidity

1. Definitions

Acidity refers to the condition of the soil when the exchange sites on soil colloids (collectively called the *exchange complex*) are dominated by hydrogen (H⁺) and aluminum (Al⁺) ions. As described above, these soils have pH <7.

2. Distribution of acid soils

Acidic soils usually occur where rainfall leaches the cations out of the soil over time. In the U.S. there is a fairly strong correlation between precipitation and pH, with soils receiving more than about 30 inches of annual precipitation having a pH < 6. (See map on page 163 of *Start with the Soil*.)

3. Problems associated with acidity

Aluminum toxicity: Aluminum becomes more available when pH is pH <6 and especially <4.75, and can be toxic to plants.

Manganese toxicity: This may occur in soil that are high in Mn and that have a pH < 5.

4. Acid soils and liming

Lime (calcium carbonate) is added to acid soils to raise the pH (see Unit 1.11, Reading and Interpreting Soil Test Reports). Calcium (Ca²⁺) replaces hydrogen and aluminum on the exchange sites. For a good reference on liming, see the Soil Quality – Agronomy Technical Note Number 8 (listed in Resources). **(See Acid Demonstration in Demonstrations.)**

◀ **FIGURE 2.8** | NUTRIENT AVAILABILITY AT DIFFERENT pH VALUES. MAXIMUM AVAILABILITY IS INDICATED BY WIDEST PART OF BAR.

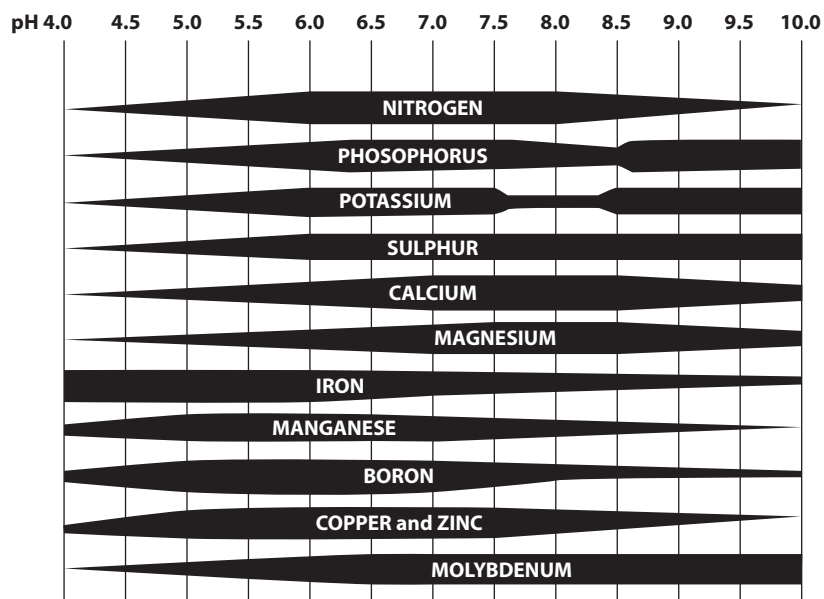

H. Alkaline, Saline, and Sodic Soils

1. Overview

Alkalinity and acidity: Soils that vary from a neutral pH have varying degrees of alkalinity ($\text{pH} > 7$) or acidity ($\text{pH} < 7$). The mean soil pH in the U.S. is around 6.4.

Salinity: Soils that have excess soluble salts in the soil solution have varying degrees of salinity

Sodicity: Soils that specifically have excess sodium in the soil solution are called sodic

2. Alkalinity

Soils in arid and semi-arid areas can lack enough rainfall to leach cations, especially calcium (Ca^{2+}), magnesium (Mg^{2+}), potassium (K^+) and sodium (Na^+), from the soil. These cations bind many of the CEC sites, blocking hydrogen (H^+) ions from binding and making the soil alkaline. This can also happen if irrigating with water high in calcium bicarbonate or magnesium bicarbonate.

3. Salinity

A soil containing sufficient soluble salts (these salts include Mg^{2+} , Na^+ , Ca^{2+} , chloride (Cl^-), sulfate (SO_4^{2-}), bicarbonate (HCO_3^-) and carbonate (CO_3^{2-}). Saline soils mainly occur in dry areas, again, where there is not enough precipitation to leach the salts from the soil, so the salts build up over time. In order for there to be salts in the soil, there must be a source for them. Some come from former ocean floors that were under ancient seas but are now exposed. Some parent material (rocks from which the soil was formed) also may release salts, such as carbonate from limestone or sodium from feldspar. **(See Salt Crust Example and Conductivity Demonstration in Demonstrations.)**

Some salts are toxic to plants and others bind so tightly to water that the plants cannot access it. In addition, it can be difficult for non-saline water to infiltrate saline soils, so it may be necessary to add gypsum to the water to aid infiltration.

4. Sodicty

A soil containing sufficient exchangeable sodium to adversely affect crop production and soil structure under most conditions of soil and plant types. Many saline soils are also sodic, although not necessarily. Sodium is toxic to plants. It also causes soil particles to disperse (separate), which causes cracking and sealing of the soil surface, leading to poor soil structure and decreased water intake.

Sodic soils can be reclaimed with a two-step process. First the sodium is flushed from CEC sites by adding amendments high in calcium (such as lime, gypsum, or dolomite) or by adding sulfur followed by lime. (The sulfur is converted to sulfuric acid by microbial activity. The sulfuric acid then reacts with lime to free calcium.) In either case, the Ca^{2+} ions replace the Na^+ cations, freeing the Na^+ in the soil solution. The second step is to leach out the sodium ions by irrigating in excess of what the plant needs.

5. Quantitative definitions

Specifically, alkaline, saline, and sodic soils are defined as such:

- a) Alkaline soil: Has a pH of > 8.5 or with an exchangeable sodium percentage (ESP, that is, the percent of the CEC occupied just by sodium) greater than 15%. Soils at this ESP contain sufficient sodium to interfere with the growth of most crop plants.
- b) Saline soil: Soil salinity is determined by measuring the electrical conductivity (EC) of a saturated paste of soil: if the EC is greater than 4 dS/m (decisiemens per meter), the soil is classified as saline. However this is a rough range: salt-sensitive plants can be affected at half this EC and highly tolerant plants can handle up to about twice this EC.
- c) Sodic soil: A soil in which the ESP is at least 15%. The amount of sodium in the soil may also be expressed by the Sodium Adsorption Ratio (SAR), which reflects the degree to which the CEC sites in the soil are occupied by sodium instead of other cations. A soil with a SAR greater than 13 is considered sodic. An ESP of 15% is roughly equivalent to a SAR of 13.
- d) Saline-sodic soil: A soil containing both high soluble salts in general and high sufficient exchangeable sodium in particular. The ESP is at least 15%, the EC of the soil solution is >4 dS/m, and the pH is usually < 8.5 .

I. Soil as a Medium for Plant Growth

1. Nutrient uptake processes

(This section is adapted from material produced by the University of Saskatchewan)

Imagine you are a tiny creature trying to move around in the soil. You are surrounded by millions of pores of all sizes and shapes, shaped and blocked by particles of organic matter and minerals. The surfaces of these particles are chemically active, adsorbing ions and organic molecules all around you. You start to learn your way around, but your microenvironment changes with each wet-and-dry cycle and freeze-and-thaw cycle. Sometimes it's not a physical process but a biological one that rearranges the structure of your little world, like a burrowing animal that tunnels through. In short, you live in a constantly changing soil ecosystem that has numerous barriers to the movement of organisms and chemicals.

In terms of soil fertility we are particularly interested in the physical component of the soil ecosystem. For a nutrient to be available for the plant to take up it must meet two criteria: 1) it must be in the proper chemical form to pass the root membrane; and 2) it must be available at the root surface.

Nutrients move through the soil to plant roots in three ways:

- root interception
- mass flow
- diffusion

Each nutrient will have one or more of these methods of movement depending on its chemical form (including how strongly they are adsorbed by mineral and organic matter particles) and soil physical and chemical conditions (including the concentration of the nutrient in the soil)

a) **Root interception**

Plant roots are constantly expanding (opening up blocked pores as they do so), growing from areas of depleted nutrients (e.g., because of prior plant uptake) to regions where nutrients are more concentrated

Although many plants, such as cereals and other grasses, have a very extensive root system, they contact less than 5% of the soil volume. The root interception mechanism is very valuable, however, because root growth can extend the root into areas where mass flow and diffusion then take over. For example, a root could grow within a few millimeters of some soil phosphorus hot spot. Although the root does not technically bump into the nutrient and intercept it, the root is close enough for diffusion to occur and the phosphorus to move into it (see below). In some cases, the presence of mycorrhizal fungi increases the nutrient-absorption capacity of root systems (see Unit 2.3, Soil Biology and Ecology). Root interception allows for uptake of some calcium, magnesium, zinc, and manganese.

b) **Mass Flow**

Growing plants are continually taking up water from the soil profile, a process driven by transpiration (loss of water from the plant via stomata on the leaves). Dissolved in the soil water are soluble nutrients. These nutrients are transported along with the water to the root surface. Nutrients, such as nitrogen as nitrate and sulfur as sulfate, that are held very weakly by soil particles readily move along with the water. But nutrients, such as phosphorus as orthophosphate, that are strongly adsorbed to the soil particles are not able to reach roots by mass flow. Mass flow allows for the uptake of most of a plant's nitrogen, calcium, magnesium, sulfur, copper, boron, manganese and molybdenum.

c) **Diffusion**

Diffusion is the movement of ions along a gradient from a high concentration to a lower concentration, until the ions are evenly distributed. For example, imagine you have a tank of water with a removable barrier in the middle. On one side of the barrier you pour ink, while the other side stays pure water. If you remove the barrier very slowly you will see the ink and water mix as the molecules move from an area of high concentration (the inky side) to an area of low concentration (the pure water side). Similarly, nutrients move from areas of high concentration in the soil solution to areas of lower concentration. This is a very slow process, but it is the dominant mechanism of movement for phosphorus and potassium, which are strongly adsorbed on the soils and present in low concentrations in the soil solution.

Lecture 2: Plant Nutrient Requirements & Nutrient Cycles

A. Plant Nutrient Requirements

1. Introduction

a) Nutrient balance

Although it is easier to consider one nutrient at a time, it is important to think of plant needs holistically. Supplying one nutrient while ignoring other plant needs, including other nutrients and environmental factors such as temperature, water, and light, may have little benefit or even be detrimental to the crop.

Justus von Liebig (1803–1873) analyzed plant samples and proposed a law of the minimum. This law states that plant growth is proportional to the amount available of the most limiting plant nutrient. For example, if I supply nitrogen sufficient to produce 70 bushels of wheat per acre but only supply enough phosphorus for 50 bushels per acre, then I will get only 50 bushels per acre (providing everything else is sufficient). This concept has since been expanded to include not only nutrients but also environmental factors.

As important as Liebig's contributions are, they do not address the situation holistically. In the above example, for instance, nitrogen that is applied in excess of what the crop will consume is in danger of being leached into the groundwater, where it will become a pollutant (see Unit 1.6, Irrigation—Principles and Practices). Also, applying too much of any one nutrient can be injurious. For example, if too much nitrogen is supplied to tomatoes relative to the amount of phosphorus supplied, you may end up with vigorous plants that don't produce any fruit.

One advantage of organic farming and gardening is that natural and organic soil amendments, unlike many synthetic ones, frequently supply many nutrients at once, including micronutrients

b) Feed the plant or feed the soil

One of the main distinctions of organic farming and gardening is its emphasis on feeding the soil rather than on feeding the plant (which most contemporary agricultural practices do). The crux of this idea is that healthy soil produces healthy, productive plants. However, we still need to keep in mind the nutrient needs of the plant, because the plant may need some nutrient that the soil is perfectly content to do without.

The reason for this is that most soils are well suited to supply the needs of the native vegetation. While a soil may have no problem supporting coastal chaparral or a deciduous forest, it may be ill suited for growing a healthy field of lettuce or a corn crop.

c) Macronutrients and micronutrients

Plant nutrients are divided into two categories. Macronutrients are those that make up the greatest proportion of the plant and so are needed in large quantities. These are nitrogen, phosphorus, potassium, sulfur, calcium, and magnesium. Micronutrients are needed in small quantities, but are no less important; however, deficiencies of these are less likely to occur. Micronutrients include boron, copper, iron, manganese, molybdenum, zinc, chlorine, and cobalt.

d) Nutrient cycling

The amount of each chemical element in the world (with some exceptions) is fixed. Consequently, if we remove all of one element from a location, it's not going to be available there anymore unless it is replaced. This is a very important consideration in soil chemistry and plant nutrition. While some nutrients cycle within the farm, returning

to the soil via manure or compost, other nutrients leave the farm, e.g., when crops are taken to market. The nutrients in these crops need to be replaced in the soil. In this sense, farming and gardening are little more than moving nutrients around.

Some details of different nutrient cycles will be discussed further below (see the sections on the individual nutrients)

e) Mobility of nutrients within the plant

Some nutrients are mobile within plants; others remain where they are. This affects how nutrient-deficiency symptoms appear. Nutrients that are mobile can move from older leaves to the sites of new growth, especially if those nutrients are in short supply. Consequently, when these nutrients are lacking, symptoms first appear in the older (lower and inner) leaves. Mobile nutrients include nitrogen, potassium, phosphorus, magnesium, molybdenum, and zinc.

Nutrients that are immobile cannot be translocated to young, new growth. As a result, deficiency symptoms first appear in younger (upper and outer) tissues. Nutrients that are immobile include sulfur, calcium, iron, manganese, boron, and copper.

2. Carbon, hydrogen, and oxygen

- a) Plants and animals are primarily made up of carbon, hydrogen, and oxygen. Plants obtain carbon and oxygen from the air (as CO_2 and O_2) and hydrogen and oxygen from water (H_2O). With the help of light energy, they recombine these three elements into carbohydrates. This happens in the leaves of plants during photosynthesis:

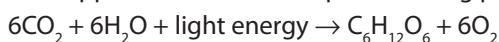

- b) Carbon, hydrogen, and oxygen also combine to form hydrocarbons, the long molecular chains that make up fats, and the same three elements combine with nitrogen to form the main structure of proteins. Overall, these three elements are key components of the large organic molecules that comprise all living beings. The carbon cycle, as depicted in ◀ Figure 2.9, the Carbon Cycle, describes the movement of carbon as it is recycled and reused by animals, plants, and microbes.
- c) Carbon also plays a key role in global climate change, as increased levels of CO_2 and CH_4 (methane) in the atmosphere (along with water vapor and a few other gases) reflect infrared radiation to the earth, overall increasing the average surface temperature. Ecologists and soil scientists have been examining the potential for building up soil organic matter as a way to sequester C, removing it from the atmosphere and maintaining it in the soil. How large a role this could play in mitigating C emissions from human activity is being debated.

3. Nitrogen (N)

- a) Physiological role in plant development

Plants take up nitrogen either as the ammonium ion (NH_4^+) or nitrate (NO_3^-). Most organic compounds in plants contain nitrogen, including amino acids, nucleic acids, many enzymes and energy transfer materials such as chlorophyll, ADP, and ATP. N is necessary for the production of sugars such as is found in sweet ripe fruit. Growing plants must have N to form new cells, so it is essential for plants.

- b) Soil nutrient imbalances

Nitrogen deficiency symptoms in plants include:

- i. Slow growth, stunted plants
- ii. Yellow-green color (chlorosis)

◀ **FIGURE 2.9** | THE CARBON CYCLE (ADAPTED FROM MICHIGAN STATE UNIVERSITY EXTENSION BULLETIN E-2646)

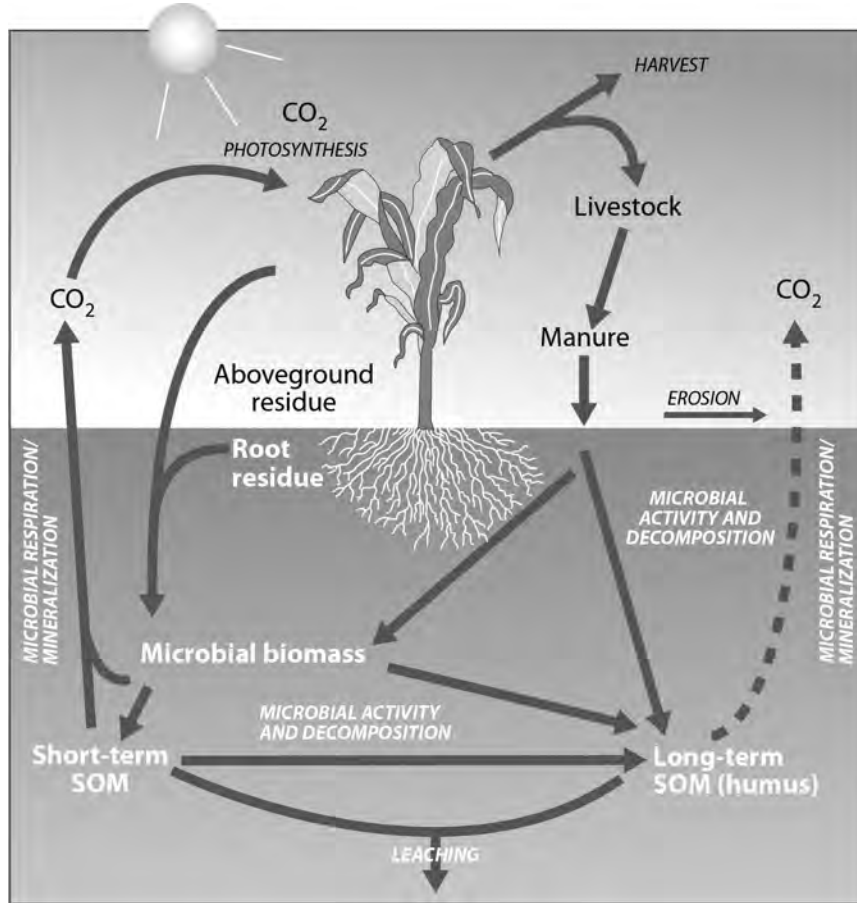

Cathy Genetti Reinhard

- iii. Firing (burnt look) of tips and margins of leaves beginning with more mature leaves
- iv. Low protein content of crops
- c) Symptoms of nitrogen excess include:
 - i. Dark green, succulent, vegetative growth at the expense of seed production in grain crops, the expense of fruit production in tomatoes and some tree crops, and the expense of sugar content in beets
 - ii. Watery potatoes
 - iii. Frost damage if there is too much succulent growth when frost hits
 - iv. Weakened stems (lodging)
 - v. Delayed flowering or fruiting
 - vi. Boron or copper deficiency due to inhibited uptake of these nutrients
- d) Forms of nitrogen in the soil

Nitrogen occurs in the soil in various forms:

 - i. Nitrogen gas in the soil air (N_2)
 - ii. Nitrate (NO_3^-)
 - iii. Nitrite (NO_2^-)
 - iv. Ammonium (NH_4^+)
 - v. Ammonia (NH_3)—a gaseous, transitory form
 - vi. In various other forms as part of complex organic molecules

These forms are the main components of the nitrogen cycle (see ◀ Figure 2.10, the Nitrogen Cycle, page 2-66)

e) Nitrogen fixation

- i. Nitrogen gas makes up about 78% of the atmosphere. It is a very stable form of nitrogen, but it is unavailable to plants. However, certain bacteria are able to transform N_2 gas into nitrate. This is called biological nitrogen fixation (as opposed to industrial nitrogen fixation carried out by chemical factories, which use large amounts of energy to “fix” the N_2 gas into ammonium). During biological N fixation, microbes form symbiotic relationships with plants: the microbes provide N to the plants and the plants provide sugars from photosynthesis to the microbes.
- ii. The main N-fixing bacteria in agricultural systems are from the genus *Rhizobium*, and are associated with plants of the bean family (Leguminosae). Bacteria in the genus *Frankia* and some species of free-living or lichen-forming cyanobacteria also are able to fix N, but are generally less important in agroecosystems.
- iii. In some cases, there may not be sufficient natural populations of *Rhizobia* to form symbioses in a high proportion of the crop, or the *Rhizobia* species present in the soil may not be the right species for the crop you are planting. In these cases it may be necessary to inoculate the seed with a commercial inoculant when the crop is planted. Some seeds come pre-inoculated, while others need to be mixed with an inoculant prior to planting.
- iv. Inoculating legume seed does not mean that it will not be necessary to supply additional N to the crop. The crop and the *Rhizobia* themselves need N to get started. Also, *Rhizobia* need sufficient phosphorus, iron, molybdenum, and cobalt.

► **TABLE 2.12** | COMPARISON OF NITROGEN FIXATION SOURCES.
VALUES ARE IN MILLIONS OF METRIC TONS PER YEAR ON A GLOBAL BASIS (APPROXIMATE VALUES)

NON BIOLOGICAL		BIOLOGICAL	
Industrial	~50	Agricultural land	~90
Combustion	~20	Forest and other land	~50
Lightning	~10	Seas	~35
TOTAL	~80		~175

f) Ammonification and nitrification

Ammonification is the release of ammonium ions from decomposing organic matter. This process is also called N mineralization, as it changes the unavailable organic forms of N into plant-usable forms. Many microbes are capable of doing this, so an environment that is favorable to microbial growth makes for fairly rapid ammonification. The ammonium that is produced is held in the soil solution, adsorbed onto CEC sites, or taken up by plants.

Nitrification is a two-stage process in which ammonium is transformed into nitrate. This, too, depends on microbial activity: *Nitrosomas* spp. oxidize ammonium to nitrite and *Nitrobacter* spp. oxidize nitrite to nitrate.

g) Denitrification

N can be lost from wet soils where anaerobic conditions occur. Under these conditions some bacteria get their oxygen from nitrate rather than oxygen gas, releasing N_2 gas back into the atmosphere. This process is called denitrification. Though N can be lost from the soil ecosystem this way, denitrification can be a very useful function where excess concentrations of nitrate occur in the soil.

To minimize denitrification, soil should have good structure and thus good aeration and drainage, a pH near neutral, and residues incorporated in the upper few inches of the soil where there is more oxygen. Note that due to microhabitats and conditions in the soil, even well- drained soils may have areas that become anaerobic at some times.

h) Immobilization

N is unavailable to plants (immobilized) when it is in the organic form. Usually, rates of mineralization in the soil are higher than rates of immobilization. However, if organic matter added to the soil has less than 1.5% N, soil microbes will rapidly take up the available N, so that the rate of immobilization will temporarily exceed the rate of mineralization. This temporarily decreases the amount of N available to plants.

i) Losses of N through leaching and volatilization

N is one of the nutrients most easily lost from the soil. Ammonia is easily volatilized, so organic matter left on the soil surface will rapidly lose total N. Volatilization increases with warmer temperatures.

N as nitrate is easily leached, moving down through the soil profile with precipitation or high levels of irrigation. This is a loss to the crop because of a decrease in the pool of plant-available N, as well as a problem for ground and surface water, where excess N generally has negative ecosystem effects. Leaching occurs most in sandier soils, exposed soils (i.e., without crops to take up the N), and in soils low in organic matter.

j) Supplying nitrogen to the soil

There are many ways that N can be supplied to the soil. These include green manures (N-fixing cover crops), crop rotation with leguminous crops, and amendments. Amendments that supply high quantities of N include animal manures, guano, cottonseed meal, bone meal, hoof and horn meal, bloodmeal, and fish emulsion.

Care must be taken when using amendments high in ammonia, such as fresh poultry manure. Ammonia is a strong base that can "burn" plants. However, its use over an extended period of time will acidify the soil as bacteria oxidize the ammonia to form nitric acid.

CARBON-NITROGEN RATIOS

Microbial action can either mineralize or immobilize nitrogen. The main factor in determining which will happen is the carbon to nitrogen (C:N) ratio. Microbes use carbon (from organic matter) for growth as well as for energy. The nitrogen entering their bodies needs to be in a fixed ratio to the amount of carbon. The critical range of the C:N ratio is ~22:1 to 25:1. Ratios higher than this (i.e., more than 25:1) will cause N to be immobilized. Lower ratios will lead to available NH_4^+ or NO_3^- as organic matter decomposes. Most plant residues have C:N ratios of 20:1-100:1; the bodies of microorganisms have a C:N ratio of 4:1 to 9:1. Usually soil OM stabilizes with a C:N ratio somewhere between 8:1 to 15:1.

NITRATE TOXICITY

When infants consume nitrate, it is converted to nitrite in the anaerobic conditions in the gut. This nitrite gets absorbed into hemoglobin molecules, which reduces their oxygen-carrying capacity, and can cause "blue-baby syndrome" (see Supplement 4, Nitrate Contamination of Groundwater, in Unit 1.5, Irrigation—Principles and Practices). In humans, nitrate can also react with amino acids to form nitrosamines, which are carcinogenic.

PHOSPHORUS AND WATER QUALITY

When soil is lost through erosion, it carries any P that is adsorbed to it. When the P enters freshwater lakes and streams it acts as a fertilizer, causing an excess growth of plants and algae. When the plants and algae die, they are consumed by microbial decomposers, which respire as their populations grow, and use up dissolved O_2 in the water. This decreases the amount of O_2 available for fish, invertebrates, and plants, in some cases creating "dead zones."

◀ **FIGURE 2.10** | THE NITROGEN CYCLE (ADAPTED FROM MICHIGAN STATE UNIVERSITY EXTENSION BULLETIN E-2646)

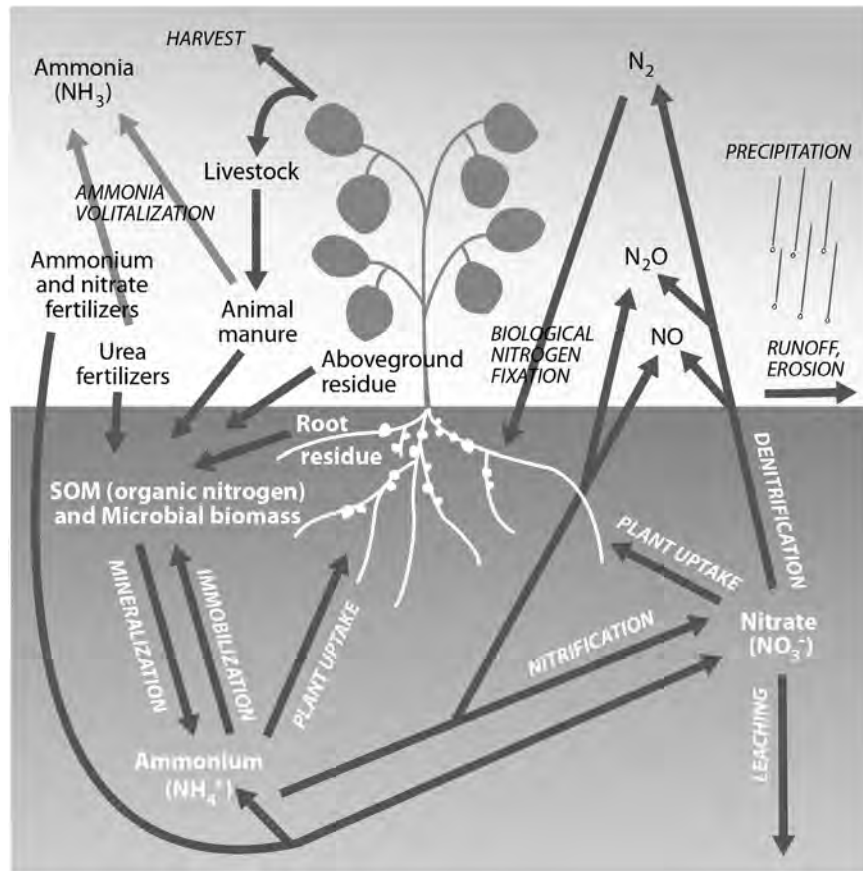

Cathy Genetti Reinhard

4. Phosphorus (P)

a) Physiological role in plant development

P is present in all living cells, including as nucleic acids (DNA and RNA), as part of phospholipid cell membranes, and as molecules for energy storage and transfer (ATP). P also stimulates early growth and root formation, hastens bloom time, and promotes seed production and size. It is used in protein synthesis and is found in legume nodules.

b) Soil nutrient imbalances

P must be balanced with N both in the plant and in the soil. In the soil, P and N compete to be taken up. Because N is highly mobile and P is one of the least mobile nutrients, excessive N availability can cause a P deficiency, even if there is enough P in the soil for the crop.

Phosphorus deficiency symptoms in plants include:

- i. Slow growth, stunting
- ii. Purplish coloration on foliage of some plants
- iii. Dark green coloration with tips of leaves dying
- iv. Delayed maturity
- v. Poor grain, fruit, or seed development

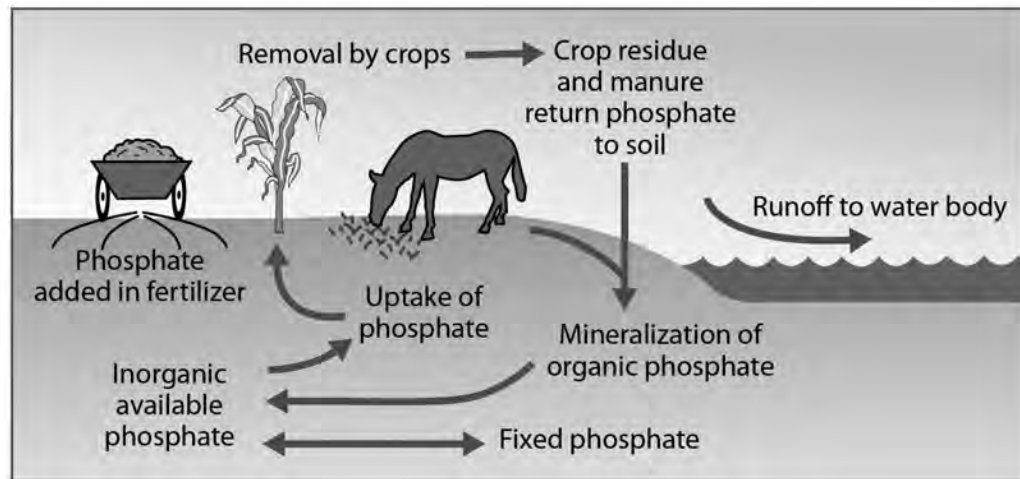

Cathy Genetti Reinhard

c) The phosphorus cycle (see ◀ Figure 2.11, the Phosphorus Cycle)

Phosphorus is not easily leached from the soil because it is adsorbed tightly to soil particles. Consequently, the main losses of P from agroecosystems are either by removal of crops (e.g., for sale and use off-farm) or by soil erosion. Most phosphate pollution of lakes and streams is from sediment that is high in P.

d) Phosphorus in soils and factors affecting its availability

- i. Plants take up phosphorus as H_2PO_4^- , HPO_4^{2-} , or PO_4^{3-} depending on soil pH. H_2PO_4^- is more available in very acid conditions while PO_4^{3-} is more available in very alkaline conditions. Maximum availability occurs between pH 6.5 and 7.2.
- ii. Some soils will bind P in nearly irreversible forms. This “fixing” capacity of a soil is largely dependent on the amount and types of clay present in the soil. For example, clays made up of iron, aluminum, and manganese oxides have high P-fixing ability. These clays are commonly found in weathered soils (Oxisols and Ultisols) in warm humid climates and in soils affected by volcanic ash (Andisols). Usually these conditions are dealt with by adding enough P to the soil to satisfy its P-fixing ability.
- iii. Phosphorus is highly immobile. Because roots only take up what is only a fraction of an inch away, if the P is not close to the root, it will not be available. Maintaining adequate moisture throughout the growing season facilitates P movement.
- iv. P availability is also affected by temperature. In cool temperatures, plants may show P deficiencies even though there is enough present in the soil for the plant needs. As temperatures warm, deficiency symptoms may go away. Organic P tends to be more available than inorganic, so use of organic amendments, along with promoting biological activity, will make P more available.

e) Phosphorus in amendments

The best source of P to use in the garden is “recycled,” from compost and manures. Compost and manures are fairly low in P content but their organic form of P may be more available than from some other sources. Organic amendments should have a pH between 6.5 and 6.8 to maximize availability. Another option is bone meal (finely ground bones from slaughterhouses), which is high in P but requires a soil pH of less than 7 for it to slowly be converted in the soil solution into a plant-available form. Rock phosphate (sold in hard and soft, or “colloidal,” forms) is another option for providing P. However, the product is mined and also needs a soil pH less than 7 for it to become plant-available.

5. Potassium (K)

a) Physiological role in plant development

Potassium plays a role in several key processes in plants:

- i. Regulating the rate of photosynthesis (by activating enzymes used in photosynthesis and by helping in the production of the energy storage molecule ATP)
- ii. Opening and closing stomata (openings on leaves) to allow CO₂ in and O₂ out and to regulate water loss
- iii. Transporting sugars within plants, again by its role in ATP production
- iv. Starch formation, by activating the enzyme responsible for this process
- v. Plant growth, by helping to produce proteins (the building blocks) and enzymes that regulate growth

b) Soil nutrient imbalances

i. Potassium deficiency symptoms in plants include:

- Slow growth
- Tip and marginal “burn” starting on more mature leaves and progressing toward the top of the plant
- Weak stalks, plants lodge (fall over) easily
- Small fruit or shriveled fruit and seeds
- Reduced disease and pest resistance
- Increased sensitivity to drought, frost, and salts
- White or yellow spots develop along the edges of clover leaves; in severe cases these join to give a scorched appearance

ii. Excess potassium can cause:

- Magnesium deficiency
- Calcium deficiency in acid soils

c) The potassium cycle (see ◀ Figure 2.12, the Potassium Cycle)

◀ **FIGURE 2.12** | THE POTASSIUM CYCLE

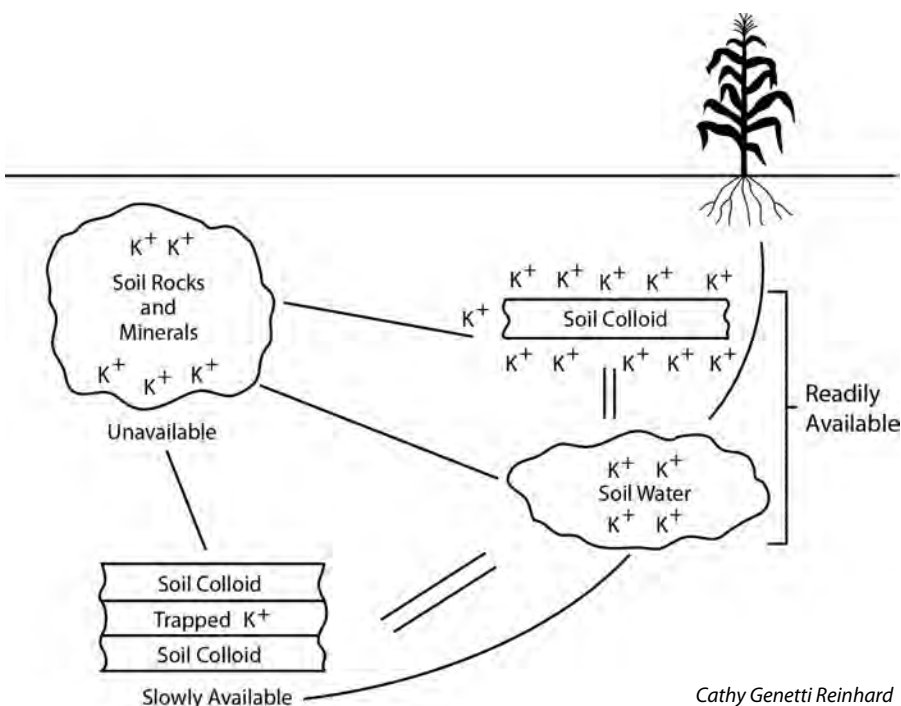

d) Potassium in soils: Factors affecting its availability

Plants take up potassium in the form of potassium ions (K⁺) from CEC sites or the soil solution. Because K dissolves readily, it is highly mobile in the soil; however, it can get trapped on CEC sites in between the layers inside clay particles.

Potassium is present in some rocks, such as granite, so soils formed from these rocks have a large supply of K. Even though a soil test may not show much K at one point in time, it is usually released in sufficient quantities for plant growth. This is the case for many soils in the Sierra Nevada and southern California.

e) Potassium in amendments

Sources of K include wood ashes, granite dust, seaweed, greensand, and langbeinite (also called sulfate of potash-magnesia or Sul-Po-Mag). Greensand and langbeinite are mined, non-renewable resources. Granite dust is also non-renewable, but granite occurs in such huge quantities over extensive areas that it will be available for a long time. In neutral or alkaline soils, wood ashes may increase the soil pH to undesirable levels.

Potassium in organic residues tends to be more highly available than that supplied by inorganic sources. So even though the total quantity of potassium supplied by these residues may be less, it may be more effective. If organic residues are regularly returned to the soil, K is not likely to be deficient.

6. Other macronutrients: Calcium, magnesium, sulfur

a) Calcium (Ca)

Calcium is an essential part of cell wall structure and must be present for the formation of new cells throughout the plant. Calcium also helps control movement into and out of cells, including by reacting with waste products to precipitate them or to render them harmless to the plant.

Calcium is not mobile in plants. Young tissue is affected first when there is a deficiency. Deficiency symptoms in plants include:

- i. Death of growing points, including on the root tips and shoot or leaf tips
- ii. Abnormal dark green appearance of foliage
- iii. Premature shedding of blossoms and buds
- iv. Weakened stems because cell membranes lose permeability and disintegrate
- v. Blossom-end rot of tomatoes
- vi. Short, thick, bulbous roots

Plants take up Ca as an ion (Ca^{2+}). Calcium is normally so abundant that it usually only needs to be added to very acidic soils where lime is required. However, excessive irrigation can leach Ca from the soil enough to cause deficiency symptoms in plants. Excess Ca can lead to a deficiency of Mg or K.

Sources of Ca include plant residues, poultry manure, wood ashes, seashells, lobster shells, legume hay, limestone, and gypsum.

b) Magnesium (Mg)

Magnesium is the central atom of chlorophyll molecules, so it is required for photosynthesis. It also helps activate key enzymes for converting CO_2 gas into carbohydrates, as well as many plant enzymes required in growth processes. Magnesium also activates enzymes necessary for P transfer within plants.

Magnesium is mobile within plants and can be translocated from older tissue to younger tissue during conditions of deficiency. Symptoms of Mg deficiency include:

- i. Chlorosis (yellowing) between the veins in older leaves; marginal yellowing with a green fir-tree shape along the big midrib of the leaf
- ii. Upward curling of leaves along their margins
- iii. Stunted growth
- iv. Ripe fruit is not sweet

Plants take up Mg in its ionic form (Mg^{2+}). Magnesium is generally available throughout the dry-climate Western states but it is often more deficient than Ca. Like Ca, Mg is easily leached, and soils with low CEC have low Mg content. It is important to have a balance of Mg, K, and Ca ions so that no one of these elements dominates the CEC sites.

Sources of Mg include plant residues, fresh poultry manure, dolomitic limestone, and langbeinite (Sul-Po-Mag—see Section on K, above)

c) Sulfur (S) (see ◀ Figure 2.13, the Sulphur Cycle)

Sulfur is part of two amino acids (cysteine and methionine) that are incorporated into proteins. Sulfur is also essential for nodule formation by N-fixing bacteria on the roots of legumes. It is present in oil compounds that give plants such as garlic and onions their characteristic odor. (Vidalia onions, known for their sweetness, come from an area that has low S soils.)

Sulfur deficiency problems can occur if growers rely on fertilizers that are concentrated with other nutrients (e.g., N, P, and K) but are free of S. Symptoms of S deficiency in plants include:

- i. Pale young leaves, light green to yellowish in color, sometimes with veins lighter than surrounding tissue. In some plants older tissue may be affected also.
- ii. Small and spindly plants
- iii. Slow growth rate and delayed maturity

Plants take up S as the sulfate ion SO_4^{2-} . Sulfur is also sometimes absorbed from the air through leaves in industrial areas where S is in high concentration.

The use of organic residues in amounts to satisfy other nutrient requirements will usually provide sufficient sulfur. Other sources of sulfur include animal manures (S is usually well balanced with N), langbeinite (Sul-Po-Mag—see section above on P), gypsum, and pure S from natural sources (granular sulfur is preferred since sulfur dust is an explosion hazard).

◀ **FIGURE 2.13** | THE SULFUR CYCLE

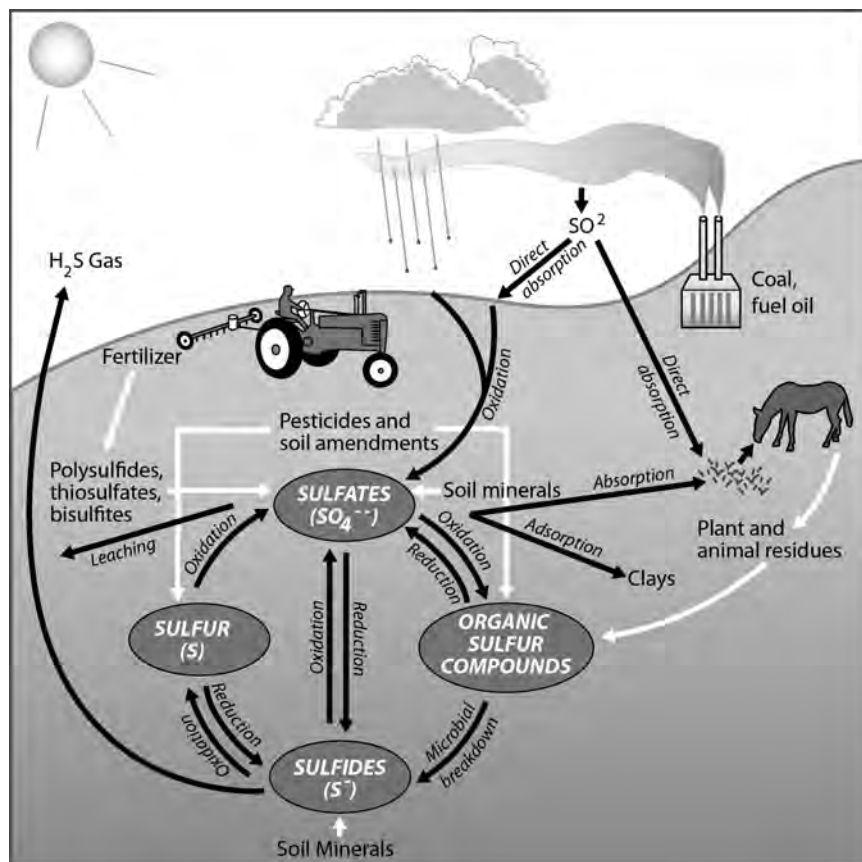

Cathy Genetti Reinhard

7. Micronutrients

a) Introduction

Micronutrients are those plant nutrients that are needed only in small quantities compared to other (macro-) nutrients. This, however, does not diminish their importance. The effects of micronutrients on plants are difficult to understand, partly because of their interrelationships with each other and with macronutrients and partly due to how the plants respond to micronutrients individually.

The response of many plants to micronutrients is nearly an all or nothing affair. As long as the concentration of the micronutrients falls within a certain range, the response of the plant is the same, regardless of the exact concentration of the nutrient. If the concentration of the nutrient falls above this range, toxicity problems occur and if the concentration is below the range, the plants become deficient in the nutrient.

Interrelationships of micronutrients and with macronutrients are many. For example, excess nitrate-N can lower pH and reduce Fe uptake. Phosphorous can form a precipitate with Fe, making the Fe unavailable for plant uptake. Iron, copper, manganese, and zinc cations can interfere with each other for plant uptake.

Availability of micronutrients is highly dependent on soil pH and organic matter. At certain pH levels, micronutrients can bind to inorganic compounds and become unavailable. Organic matter can diminish the effect of pH, supplying micronutrients if their concentrations in the soil are low and binding them up if their concentrations are too high, reducing their toxicity.

b) Boron ($B_4O_7^{2-}$)

i. Boron is needed in plants for:

- Synthesizing protein
- Transporting starches and sugars
- Regulating N and carbohydrate metabolism
- Root growth
- Fruit and seed formation
- Water uptake and transport
- Boron contributes more than any other micronutrient to the quality of produce.

ii. Boron is non-mobile in plants and so a continuous supply is necessary at all growing points. Symptoms of boron deficiency include:

- Death of terminal growth, causing lateral buds to develop and producing a "witches'-broom" effect
- Thickened, curled, wilted, and chlorotic leaves
- Soft or necrotic spots in fruit or tubers
- Reduced flowering or improper pollination

Boron is required in minute quantities by plants, but may be insufficient in some soils. Boron can also become toxic in amounts not much higher than that needed by plants. Boron toxicity is most frequently a problem in soils formed at the bottoms of enclosed basins in arid areas where groundwater evaporates upward through the soil, leaving salt concentrations near the surface (playas).

c) Copper (Cu^{2+})

Copper is a catalyst for respiration (combusting sugars for energy in plants) and an activator of several enzymes. It is important for carbohydrate and protein synthesis.

Symptoms of copper deficiency include:

- i. Stunted growth
- ii. Dieback of terminal shoots in trees
- iii. Poor pigmentation

- iv. Wilting and eventual death of leaf tips
- v. Formation of gum pockets around central pith in oranges

Copper is fairly abundant and deficiencies rarely occur. It is found as impurities in the structures of clay particles and other soil compounds. As these materials weather the copper is released, and then adsorbed onto CEC sites, from where it may be taken up by plants or leached from the soil. Consequently, soils formed from highly weathered materials may be deficient in copper. However, since copper can be highly toxic at low levels, amendments should not be used except where the need for it has been established.

d) Iron (Fe^{2+} , Fe^{3+})

Iron plays several critical roles in plants. It is used in chlorophyll synthesis, during respiration, and as a constituent of some enzymes and proteins. It also activates nitrogen fixation.

Symptoms of Fe deficiency include:

- i. Interveinal chlorosis—a yellowing of the leaves between the veins
- ii. Twig dieback
- iii. Death of entire limbs or plants

Plants require Fe in larger amounts than any other micronutrient. Iron is very abundant in the soil, but some of its forms are so insoluble that plants may suffer a deficiency in spite of its abundance (this would be like being stranded in the ocean yet being thirsty for want of fresh water). This is particularly true at pH levels above 7; where there is a high content of lime or manganese; or where there is poor aeration. Treatment may consist of adding iron in a form that won't be bound up in the soil or by lowering the soil pH.

e) Manganese (Mn^{2+})

Manganese is part of multiple enzymes and is a catalyst of other enzymes, and so is used in the metabolism of N and inorganic acids; for the formation of vitamins (carotene, riboflavin, and ascorbic acid); for the assimilation of CO_2 during photosynthesis; and in the breakdown of carbohydrates.

Symptoms of manganese deficiency include:

- i. Interveinal chlorosis of young leaves, with a gradation of pale green coloration with darker color next to the veins. There is no sharp distinction between veins and interveinal areas as with iron deficiency.
- ii. Development of gray specks, interveinal white or brown streaks, or interveinal brown spots

Similar to Fe, high pH (over 6.5) may make Mn unavailable, as can soils very high in organic matter (muck soils). High Mn levels may induce iron deficiency. Improving soil structure can improve Mn availability.

f) Molybdenum (MoO_4^{2-})

Molybdenum is necessary for nitrogen fixation and for converting nitrate-N taken up by plants into a form the plant can use to build amino acids and thus proteins. Because of this a Mo deficiency can cause an N deficiency in plants.

Symptoms of molybdenum deficiency include:

- i. Stunting and lack of vigor (induced nitrogen deficiency)
- ii. Marginal scorching and cupping or rolling of leaves
- iii. "Whiptail" of cauliflower
- iv. Yellow spotting of citrus

As with boron, molybdenum is needed only in minute quantities and is toxic at levels above what plants require. Molybdenum has been found in quantities sufficient to be toxic to livestock in forage grown in inland desert areas such as the San Joaquin Valley and Nevada. Molybdenum levels tend to be low in highly leached soils.

g) Zinc (Zn^{2+})

Zinc activates enzymes that run photosynthesis, helps regulate and combust carbohydrates, and is part of the synthesis of the plant hormone auxin. It is also key for seed and grain maturation and production.

Symptoms of zinc deficiency include:

- i. Decrease in stem length and a rosetting of terminal leaves
- ii. Reduced fruit bud formation
- iii. Mottled leaves (interveinal chlorosis)
- iv. Dieback of twigs after first year
- v. Striping or banding on corn leaves

Soils formed from highly weathered materials may be deficient in Zn, while soils formed from igneous rocks tend to have higher levels of Zn. Warm soil temperatures improve Zn availability, as does a well-aerated soil. High levels of available P can cause Zn deficiency in plants.

h) Others

Other micronutrients that may be of importance are:

i. Cobalt (Co^{2+})

Cobalt has not yet been shown to be essential for plants, but is generally beneficial. However, it is essential in the symbiotic relationship between legumes and their associated Rhizobia bacteria.

ii. Chlorine (Cl)

Chlorine is required for photosynthetic reactions in plants. However, the quantities needed are so small that deficiencies are rare and usually in places with high rainfall and sandy soils, where Cl anions would leach out.

iii. Silicon (Si)

While not an essential plant nutrient, Si gives plants mechanical strength and may help minimize water loss and increase disease resistance. Plant pathologists are especially interested in the potential for improving disease resistance.

Demonstrations: Soil Chemistry

DEMONSTRATION OVERVIEW

The following demonstrations provide visual representations and visual analogies for the concepts presented in Lecture 1. When possible, they should be integrated into the lectures.

MAGNET DEMONSTRATION

Lecture 1, D. 1

PURPOSE

To show how unlike charges attract and like charges repel

MATERIALS

- 2 bar magnets, preferably labeled

METHODS

Hold the negative ends of the magnets together, show how they repel, then hold the negative to the positive and show how they attract.

pH DEMONSTRATION

Lecture 1, F. 1

PURPOSE

To demonstrate different methods of measuring pH

MATERIALS

- pH meter
- Colorimetric pH test kit (I use the Hellige-Truog)

METHODS

Measure the pH of the soil sample using the different techniques. Compare the results. Explain why differences may occur.

ACID DEMONSTRATION

Lecture 1, G. 4

PURPOSE

To show how to test for the presence of carbonates in the soil

MATERIALS

- Soil sample with free carbonates, e.g., CaCO_3
- Dilute hydrochloric acid or vinegar

METHODS

Drop acid onto the soil to show how it effervesces. The effervescence is the release of CO_2 bubbles from the carbonates.

SALT CRUST EXAMPLE

Lecture 1, H. 3

PURPOSE

To show how high salt concentrations might look in the soil

MATERIALS

- Salt crust

METHODS

Pass around samples of salt-encrusted soil

CONDUCTIVITY DEMONSTRATION

Lecture 1, H. 3

PURPOSE

To demonstrate that saline soils conduct electricity

MATERIALS

- Saline soil sample
- Nonsaline soil sample
- Distilled water
- 2 beakers or jars
- Table salt
- Conductivity tester: Any kind of device that shows that electricity will pass through a saline soil but not a nonsaline soil will do. A device that combines a light bulb and a voltmeter is a good choice.

METHODS

1. Prepare the two samples (saline and nonsaline) by placing them into separate jars and mixing distilled water into each until a smooth paste is created.
2. Place the electrodes of the tester into the nonsaline sample. Notice that the light bulb does not light.
3. Remove the electrodes and rinse them with distilled water. Then place them into the saline soil. Notice that the light bulb lights.
4. Remove electrodes from samples and rinse them with distilled water. Place them back into the nonsaline sample. Stir in table salt until enough has been added to make the light bulb light up.

Note: The operation can be simplified by having four electrodes. Use alligator clips on the tester wires to connect them to the electrodes.

Assessment Questions

TRUE OR FALSE

- 1) The bulk of a plant is made up of minerals extracted from the soil.
True False
- 2) Clay soils can hold more nutrients than sandy soils.
True False
- 3) The main source of nitrogen in the soil is rocks.
True False
- 4) Phosphorus becomes a pollutant when it is leached into the groundwater.
True False
- 5) Alkaline soils are predominant in the arid western states.
True False

MULTIPLE CHOICE

- 1) Which one of the following refers to the nutrient-holding ability of the soil?
 - a. Alkalinity
 - b. Cation Exchange Capacity
 - c. Available Water Capacity
 - d. Nutrient Loading
- 2) Leaching of bases out of a soil causes the soil to become
 - a. Alkaline
 - b. Acid
- 3) Salinity problems are most likely to occur in
 - a. Dry environments
 - b. Upper New York state
 - c. Tropical rainforests
 - d. Humid areas
- 4) Which of the following is NOT a plant nutrient?
 - a. Nitrogen
 - b. Copper
 - c. Aluminum
 - d. Potassium
- 5) Nutrients needed in large quantities by plants are called
 - a. Meganutrients
 - b. Micronutrients
 - c. Macronutrients
 - d. High end nutrients
- 6) Certain plant nutrients are called micronutrients because
 - a. They are too small to see with the naked eye
 - b. They are not all that important to the plant
 - c. They are only needed in small quantities

- 7) Which one of the following plant nutrients comes from the air?
- Carbon
 - Potassium
 - Hydrogen
 - Copper
- 8) Which of the following affects nutrient availability? (circle all correct responses)
- pH
 - Soil organic matter content
 - Texture
 - Soil moisture
- 9) An ion with a positive charge is called a(n)
- Cation
 - Anion
 - Onion
 - Positron
- 10) Clay particles tend to have a
- Positive charge
 - No charge
 - Negative charge

ASSESSMENT

- 1) How can knowledge of the climate of an area help you make an initial assessment of soil fertility?
- 2) Your plants are showing signs of iron deficiency. You check the soil pH and it is 8.0. What would most likely be the best way to eliminate the iron deficiency and why?

- 3) You know that the air around you is full of nitrogen, yet your garden regularly shows signs that it could use a little of it. How can you harness some of the nitrogen for your garden?
- 4) Is adding a large quantity of nitrogen-rich amendments to your garden before you plant necessarily a good thing to do? Why or why not?
- 5) What is the most important thing you can do to a mineral soil in order to ensure an adequate supply of and maximum availability of plant nutrients?

Assessment Questions Key

TRUE OR FALSE

- 1) The bulk of a plant is made up of minerals extracted from the soil.
True **False**
- 2) Clay soils can hold more nutrients than sandy soils.
True *False*
- 3) The main source of nitrogen in the soil is rocks.
True **False**
- 4) Phosphorus becomes a pollutant when it is leached into the groundwater.
True **False**
- 5) Alkaline soils are predominant in the arid western states.
True *False*

MULTIPLE CHOICE

- 1) Which one of the following refers to the nutrient-holding ability of the soil?
a. Alkalinity
b. Cation Exchange Capacity
c. Available Water Capacity
d. Nutrient Loading
- 2) Leaching of bases out of a soil causes the soil to become
a. Alkaline
b. Acid
- 3) Salinity problems are most likely to occur in
a. Dry environments
b. Upper New York state
c. Tropical rainforests
d. Humid areas

- 4) Which of the following is NOT a plant nutrient?
a. Nitrogen
b. Copper
c. Aluminum
d. Potassium
- 5) Nutrients needed in large quantities by plants are called
a. Meganutrients
b. Micronutrients
c. Macronutrients
d. High end nutrients
- 6) Certain plant nutrients are called micronutrients because
a. They are too small to see with the naked eye
b. They are not all that important to the plant
c. They are only needed in small quantities
- 7) Which one of the following plant nutrients comes from the air?
a. Carbon
b. Potassium
c. Hydrogen
d. Copper
- 8) Which of the following affects nutrient availability? (circle all correct responses)
a. pH
b. Soil organic matter content
c. Texture
d. Soil moisture
- 9) An ion with a positive charge is called a(n)
a. Cation
b. Anion
c. Onion
d. Positron

10) Clay particles tend to have a

- a. Positive charge
- b. No charge
- c. Negative charge

ASSESSMENT

1) How can knowledge of the climate of an area help you make an initial assessment of soil fertility?

- Humid areas tend to be more heavily leached, have lower pH and lower fertility
- Dry areas tend to have higher base saturation, higher pH, more fertile
- Warm areas tend to have more highly weathered soils as compared to cooler ones, lower relative fertility

2) Your plants are showing signs of iron deficiency. You check the soil pH and it is 8.0. What would most likely be the best way to eliminate the iron deficiency and why?

- Lower the pH so that the iron in the soil can become more available (usually done by adding sulfur or acid organic materials). If iron supplements are used they, too, will be unavailable due to the high pH unless chelated forms of iron are used.

3) You know that the air around you is full of nitrogen, yet your garden regularly shows signs that it could use a little of it. How can you harness some of the nitrogen for your garden?

- Nitrogen-fixing green manures
- Intercrop with nitrogen-fixing plants

4) Is adding a large quantity of nitrogen-rich amendments to your garden before you plant necessarily a good thing to do? Why or why not?

No.

- Large amounts of nitrogen without plants to take it up can lead to losses by leaching (polluting groundwater) or volatilization (polluting air)
- Too much nitrogen can burn seedlings
- An imbalance of nitrogen with respect to other nutrients is unhealthy for the plants

5) What is the most important thing you can do to a mineral soil in order to ensure an adequate supply of and maximum availability of plant nutrients?

Maintain high levels of organic matter and foster biological activity

Organic matter helps by

- Buffers micronutrients, keeping them from becoming toxic or imbalanced
- Chelates certain micronutrients to keep them available to plants
- Increases cation exchange capacity
- Supplies certain nutrients such as nitrogen, phosphorus, and sulfur
- Improves physical condition of soil (air and water relationships enhanced), which helps to ensure maximum availability of nutrients
- Buffers the effect of high or low pH

Biological activity helps by

- Breaking down certain compounds to release nutrients
- Breaking down organic matter
- Some micro-organisms are involved with nitrogen fixation
- Organisms can help move otherwise immobile nutrients through the soil

Resources

PRINT RESOURCES

Brady, Nyle C., and Ray R. Weil. 2008. *The Nature and Property of Soils, 14th Edition*. Upper Saddle River, New Jersey: Prentice-Hall, Inc.

A good general soils text, used for introductory soils classes at universities. great for those who want to “go deeper” into the origins, classifications, and workings of soil.

California Fertilizer Association. 1997. *Western Fertilizer Handbook, 2nd Edition*. Danville, IL: The Interstate Printers & Publishers, Inc.

This book contains general information about soils and more detailed information about plant nutrients and fertilizers. Some parts may be difficult to understand. Emphasis is on inorganic fertilizers.

Foth, Henry D. 1990. *Fundamentals of Soil Science, 8th Edition*. New York: John Wiley & Sons.

Gershuny, Grace. 1993. *Start with the Soil*. Emmaus, PA: Rodale Press.

A general book on soils and soil management geared toward organic gardeners. Easy to read and understand.

Hanson, Blaire, Stephen R. Grattan, and Alan Fulton. 1999. *Agricultural Salinity and Drainage*. Publication 3375. UC Irrigation Program. Oakland, CA: University of California Division of Agriculture and Natural Resources.

An indispensable reference for anyone farming in an area where salinity might be a problem.

Parnes, Robert. 1990. *Fertile Soil: A Grower's Guide to Organic and Inorganic Fertilizers*. Davis, CA: agAccess.

Probably the best reference here on plant nutrients, with good coverage of organic amendments. Some useful reference charts in the appendices.

Stell, Elizabeth P. 1998. *Secrets to Great Soil*. Pownal, VT: Storey Communications, Inc.

An easy to read primer on soils, composting, and basic gardening techniques. Lots of diagrams.

Troeh, F. R., and L. M. Thomposon. 2005. *Soils and Soil Fertility, 6th Edition*. Ames, IA: Wiley-Blackwell.

A general soils text used in introductory soils classes.

WEB-BASED RESOURCES

LIMING (PH)

Liming to Improve Soil Quality in Acid Soils – Agronomy Technical Note No. 8. USDA.

www.nrcs.usda.gov/Internet/FSE_DOCUMENTS/nrcs143_019229.pdf

SALINITY

Saline and Sodic Soils

www.ag.ndsu.edu/langdonrec/soil-health/saline-sodic-soils/view

CARBON

C sequestration potential

www.strauscom.com/rodale-whitepaper/

NITROGEN

www.extension.umn.edu/agriculture/nutrient-management/nitrogen/understanding-nitrogen-in-soils

PHOSPHORUS

www.extension.umn.edu/agriculture/nutrient-management/phosphorus/the-nature-of-phosphorus/

www.extension.umn.edu/agriculture/nutrient-management/phosphorus/understanding-phosphorus-fertilizers/

www.ess.uci.edu/~reeburgh/fig4.html

www.sera17.ext.vt.edu/SERA_17_Publications.htm

POTASSIUM

www.ipipotash.org

www.extension.umn.edu/agriculture/nutrient-management/potassium/

SULFUR

www.extension.umn.edu/agriculture/nutrient-management/secondary-macronutrients/

www.soils.wisc.edu/extension/pubs/A2525.pdf

CALCIUM

soils.usda.gov/sqi/files/08d3.pdf
www.soils.wisc.edu/extension/pubs/A2523.pdf
www.psu.edu/ur/NEWS/news/liming.html

BASE CATION SATURATION RATIO

www.extension.umn.edu/agriculture/nutrient-management/soil-and-plant-sampling/soil-cation-ratios/

NUTRIENT CYCLING & SOIL FERTILITY

www.extension.umn.edu/distribution/horticulture/m1193.html#nutp

MISCELLANEOUS NUTRIENTS

eap.mcgill.ca/MagRack/COG/COGHandbook/COGHandbook_1_3.htm
www2.hawaii.edu/~nvhue/sustain_ag/sustag895.html

DEFICIENCY SYMPTOMS

extension.arizona.edu/sites/extension.arizona.edu/files/pubs/az1106.pdf

INSTITUTIONS

Cooperative Extension Service or Farm Advisors Office

Staff from these agencies will be aware of crop nutrient needs and problems in your area. They can assist you with nutrient deficiency symptoms and known plant nutrition problems in your area.

Soil and Plant Tissue Labs

These labs can test your soil or crop for deficiencies. Some websites containing listings of laboratories:

attra.ncat.org/attra-pub/soil_testing/
gardeningproductsreview.com/resources/soil-testing-for-the-home-gardener/state-state-list-soil-testing-labs-cooperative-extension-offices/
www.al-labs-west.com/
www.clemson.edu/agrvl/b/sera6/changes/accompl.htm

Soil Biology and Ecology

Introduction	85
Lecture 1: Soil Biology and Ecology	87
Demonstration 1: Organic Matter Decomposition in Litter Bags	
Instructor's Demonstration Outline	101
Step-by-Step Instructions for Students	103
Demonstration 2: Soil Respiration	
Instructor's Demonstration Outline	105
Step-by-Step Instructions for Students	107
Demonstration 3: Assessing Earthworm Populations as Indicators of Soil Quality	
Instructor's Demonstration Outline	111
Step-by-Step Instructions for Students	113
Demonstration 4: Soil Arthropods	
Instructor's Demonstration Outline	115
Assessment Questions and Key	117
Resources	119
Appendices	
1. Major Organic Components of Typical Decomposer Food Sources	121
2. Litter Bag Data Sheet	122
3. Litter Bag Data Sheet Example	123
4. Soil Respiration Data Sheet	124
5. Earthworm Data Sheet	125
6. Arthropod Data Sheet	126

Introduction: Soil Biology & Ecology

UNIT OVERVIEW

This unit introduces students to the biological properties and ecosystem processes of agricultural soils.

The lecture reviews the constituents of soils and the physical characteristics and soil ecosystem processes that can be managed to improve soil quality. Demonstrations and exercises introduce students to techniques used to assess the biological properties of soils. Such assessments help inform decisions about soil management with the goal of maintaining crop productivity and soil health in organic farming and gardening systems.

MODES OF INSTRUCTION

- > LECTURE (1 LECTURE, 1.5 HOURS)
The lecture covers the basic biology and ecosystem processes of soils, focusing on ways to improve soil quality for organic farming and gardening systems.
- > DEMONSTRATION 1: ORGANIC MATTER DECOMPOSITION (1.5 HOURS)
In Demonstration 1, students will learn how to assess the capacity of different soils to decompose organic matter. Discussion questions ask students to reflect on what environmental and management factors might have influenced the test results and what the results suggest about nutrient cycling rates and the quality/health of the soils tested.
- > DEMONSTRATION 2: SOIL RESPIRATION (1 HOUR)
Demonstration 2 covers the use of Draeger gas detection tubes for measuring carbon dioxide levels liberated from soils as an indicator of soil biological activity and soil quality/health.
- > DEMONSTRATION 3: EARTHWORM POPULATION (1 HOUR)
Demonstration 3 takes students through the process of sampling soil for earthworm types. Discussion questions ask students to consider the presence and abundance of certain earthworm types as indicators of soil quality/health.
- > DEMONSTRATION 4: SOIL ARTHROPODS (1 HOUR)
Demonstration 4 covers the preparation and materials used to collect and identify soil arthropods. Discussion questions ask students to consider the presence and diversity of soil arthropods as indicators of soil quality/health.
- > ASSESSMENT QUESTIONS (1 HOUR)
Assessment questions reinforce key unit concepts and skills.

LEARNING OBJECTIVES

CONCEPTS

- Soil quality/soil health
- Mineralization/immobilization
- Autotrophic/heterotrophic food webs
- Functional groups of soil biota
- Rhizosphere ecology
- Management effects on soil ecosystems

SKILLS

- How to assess soils for biological activity through measuring the rate of decomposition of cellulose
- How to assess soil biological activity through measuring soil respiration
- How to assess soil biological activity through earthworm census
- How to assess the soil ecosystem structure through a soil arthropod census

Lecture 1: Soil Biology & Ecology

Pre-Assessment Questions

1. What is soil?
2. What forms of life exist in soil ecosystems?
3. How would you define a “healthy” agricultural soil?
4. What is a food web?
5. Can you describe a decomposer food web that may exist in the soil?
6. What might be some negative effects of the long-term practice of monoculture cropping and the use of synthetic chemical fertilizers and pest control agents on the soil ecosystem?

A. What Is Soil? (should be a review in part; see also Unit 2.1, Soils and Soil Physical Properties)

1. Soil components
 - a) Mineral
 - i. Derived from parent material
 - b) Soil organic matter
 - c) Water and air
 - i. 1/2 soil volume = pore space
 - ii. Importance of gas diffusion: When diffusion is slow, as with water-saturated soil, respiration byproducts (such as CO₂) accumulate and inhibit aerobic processes (such as respiration itself)
 - iii. CO₂ is about 1% in dry soil, up to 10% in saturated soil
 - d) Biota: The smallest life forms are inseparable from soil organic matter
2. Soil structure vs. soil texture
 - a) Soil texture, a native characteristic
 - i. Soil texture: The relative percentage of sand, silt, and clay particles
 - ii. The bricks, boards, and mortar (the physical materials) that make up soil
 - iii. The particle sizes have surface area:volume effects. This influences properties such as cation exchange capacity (CEC), pore space, water holding capacity, and aggregate formation.
 - b) Soil structure, a manageable characteristic
 - i. Soil structure: The arrangement of soil particles. The “architecture” of soil—what shapes you build with the “bricks, boards and mortar.”
 - ii. Determines movement of gases and water in soil
 - iii. Creates small habitat spaces
 - iv. Water stability: Aggregates that retain shape when wetted maintain a more stable soil structure
 - v. Influences soil tilth/soil health

B. What Is a Healthy Soil? (see also Unit 1.1, Managing Soil Health)

1. Question: Is soil merely a solid medium that holds nutrients for plant growth or does soil serve other functions?
2. Soil health and soil quality are generally synonymous
3. Definition of soil health: “Capacity of a soil to function, within land use and ecosystem boundaries, to sustain biological productivity, maintain environmental quality, and promote plant, animal, and human health.”

- a) Soil is recognized as an essential component of the biosphere
 - b) Soil is required for significant production of food and fiber
 - c) Soil contributes to maintaining and enhancing air and water quality
 - d) Soil filters and chemically alters water
 - e) The definition of soil health must be broad enough to encompass the many functions of soil
4. Assessment of soil health
- a) Analogous to monitoring human health
 - b) Indicators needed to identify problems and to monitor the effects of management
 - c) Requires a holistic approach
 - d) Should include physical, chemical, and biological attributes of soil
 - e) Indicators must be measurable by as many people as possible, at many different skill levels
 - f) Definition and assessment of soil quality is complicated by the fact that soil is not (typically) directly consumed by animals and humans, unlike air and water
 - g) Basic data set of soil health indicators
 - i. Soil texture
 - ii. Rooting depth
 - iii. Water infiltration
 - iv. Bulk density
 - v. Water holding capacity
 - vi. Soil organic matter
 - vii. pH
 - viii. Cation exchange capacity (CEC)
 - ix. Extractable N, P, and K
 - x. Microbial biomass C and N
 - xi. Potentially mineralizable N
 - xii. Soil respiration
 - xiii. Soil temperature
5. Protection of soil health as a national priority
- a) National Research Council recommendation (1993): "Protecting soil quality, like protecting air and water quality, should be a fundamental goal of national environmental policy"
 - b) National Resource Conservation Service (2012): Healthy soils initiative called "Unlock the Secrets of the Soil" (www.nrcs.usda.gov/wps/portal/nrcs/main/national/soils/health/)
 - c) USDA Sustainable Agriculture Research and Education program (2014): Organized National Conference on Soil Health and Cover Crops (www.sare.org/Events/National-Conference-on-Cover-Crops-and-Soil-Health)

C. Nutrient Cycling and Decomposition

1. Mineralization/immobilization
- a) Soil nutrients occur as parts of:
 - i. Inorganic compounds: Some of these are available to plants
 - ii. Organic compounds: Are part of living organisms and decaying organic matter. These nutrients are stored ("immobilized") in the biomass of the organisms and are unavailable until released during decay or consumption.
 - b) Soil organisms are constantly transforming nutrients between these 2 forms

- c) Mineralization: Soil organisms excrete inorganic waste compounds that may adhere to CEC sites and/or dissolve in soil water (soil solution) for possible uptake by crop plants. Net mineralization must be greater than net immobilization for nutrients to be available to crop plants.
 - d) Immobilization: Soil organisms consume inorganic compounds to construct living tissues. These nutrients are temporarily stored and unavailable for plant uptake.
2. Soil organic matter (SOM): Includes all organic substances in or on the soil
- a) Living organisms—include plant roots and all soil biota (< 5% of SOM)
 - i. Cellulose, the major carbohydrate structural building block for plants, is the most abundant compound on earth and the major component of soil organic matter
 - ii. Lignin is the second largest input into SOM
 - b) Fresh and decomposing organic residues (40–60% of SOM)
 - i. Easily decomposable (active, labile) fraction: The quantity of this fraction of SOM changes quickly in response to management practices and is the organic matter fraction from which the majority of plant nutrients are liberated into the soil solution for uptake by plants
 - ii. Moderately decomposable fraction: This fraction is physically and/or chemically more complex than labile OM. Its decomposition is slower and therefore fewer nutrients are mineralized from it in a given season.
 - c) Resistant (recalcitrant) fraction: Also called humus, and is resistant to further decomposition (33–50% of SOM). Has greater influence on the structure/physical properties of soils than on nutrient availability.
 - d) See Appendix 1, Major Organic Components of Typical Decomposer Food Sources
 - e) Physical factors influencing decomposition
 - i. Particle size: High surface area:volume = more rapid decomposition. For example, flail mowing breaks cover crops into smaller pieces for more rapid decomposition prior to planting a subsequent crop.
 - ii. Some surface properties of plants (e.g., waxes, pubescence) decrease the rate of decomposition
 - iii. High content of structural compounds, e.g., lignin that supports woody plant stems, decreases the rate of decomposition
 - f) Limiting factors in decomposition of SOM
 - i. Nutrient availability: Decomposers tend to concentrate the nutrients that are in short supply, e.g., N, P, and K. Micronutrients are not usually a limiting factor.
 - ii. C:N ratio of organic matter: High abundance of C compared to N slows the decomposition process. If C:N < 20–30:1 = net mineralization. If C:N > 20–30:1 = net immobilization
 - iii. Soil moisture: Necessary for respiration by organisms doing the decomposition
 - iv. Oxygen levels: Also necessary for respiration by decomposers
 - g) Plant secondary compounds may inhibit decomposition (such as polyphenols, tannins found in many woody perennials)
3. Nitrogen cycle (see ◀ Figure 2.10 in Unit 2.2, Soil Chemistry and Fertility)
- a) Proteins break down → amino acids → ammonium (form of N usable by some plants) → nitrate (form of N usable by most plants)
 - b) Ammonification (aerobic or anaerobic): The biochemical process in the N cycle above whereby ammonium is released from nitrogen-containing organic compounds (amino acids)

- c) Nitrification (aerobic): The biochemical process in the N cycle above whereby bacteria convert ammonium to nitrate
 - i. Inhibited by low oxygen or low temperatures
 - ii. This leads to ammonium build-up in cold, wet soils

D. Soil Food Webs

1. Soil food web ecology
 - a) Food webs trace the path of energy or nutrients passing from one organism to the next
2. Heterotrophs vs. autotrophs in food webs
 - a) Autotrophs form the base of food webs, and acquire their own C from the atmosphere. In the soil food web, this begins with C fixation by plants, which is photosynthesis. Energy for most life is derived from sunlight that has been transformed by photosynthetic plants into organic compounds.
 - b) Heterotrophs in food webs consume organic matter to acquire carbohydrates for respiration. By consuming organic matter, they release nutrients, making them available to other plants and animals, or become food themselves for other organisms.
 - c) Energy loss = 80–90% at each step in the food chain
 - d) Food web structure and properties
 - i. Resilience = speed of recovery after disturbance. Resilience decreases with increasing number of trophic levels due to increasing complexity—it takes longer to reestablish complex food web relationships
 - ii. Disturbance selects for shorter food chains: In farmed soils, disturbance can be chemical (pesticides, fertilizers) or physical (cultivation, organic matter incorporation, removal of surface organic layer)

*The frequency of soil disturbance by physical or chemical agricultural inputs and other disturbances is important to the overall assemblage of soil biota and food chain length
 - iii. Fungi:bacteria biomass ratio characteristics of soil ecosystems
 - Productive agricultural soils have a ratio of 1:1 or less (higher in no-till). These are bacterial-dominated food webs with rapid cycling of nutrients.
 - Deciduous forest soils, 5:1 to 10:1 (fungal dominated)
 - Coniferous forest soils, 100:1 to 1000:1 (fungal dominated)
 - e) Some heterotrophic roles in soil food webs
 - i. Shredders: Shred organic matter, increasing the surface area and making the food available to more microorganisms. These include earthworms and arthropods.
 - ii. Grazers: Feed on bacteria and fungi, stimulating and controlling the growth of those populations. Grazers include protozoa, nematodes, and microarthropods.
 - iii. Higher-level predators: Consume other heterotrophs, like grazers and shredders, helping control the lower trophic-level predator populations
 - f) Unique food web for each ecosystem, determined by:
 - i. Climate
 - ii. Soil/parent material
 - iii. Vegetation
 - iv. Land management practices

E. Soil Biota

1. Community characteristics
 - a) High diversity of organisms in soil can rival that of coral reef ecosystems
 - b) High abundance of organisms, on the order of hundreds of millions to billions of microbes in 1 g of soil
 - c) High biomass of organisms, e.g., from hundreds to thousands of pounds of microbes per acre of soil
2. Habitats
 - a) Habitats within soil ecosystems are unevenly distributed
 - b) Habitats are concentrated at organic matter sites
 - i. Root zone (rhizosphere)
 - Succession of organisms as root grows
 - Some root exudates (molecules released into the soil by the roots, including sugars and amino acids) may stimulate microorganisms and thus increase labile SOM
 - ii. Litter (dead organic matter on the soil surface)
 - iii. Surfaces of soil aggregates
 - iv. Incorporated organic matter
3. Functional classification
 - a) Microorganisms
 - i. Colonial growth forms (cells about 1/25,000 inch wide)
 - Bacteria, archaea, and yeast
 - Adapted to high surface area:volume environments
 - Colonize surfaces, crevices, pores
 - Teaspoon of soil contains 100 million to 1 billion bacteria
 - Biomass equivalent to 2 cows per acre
 - Functional roles include: N fixers, nitrifiers, denitrifiers, decomposers (the byproducts of which help in the formation of soil aggregates), pathogens
 - ii. Mycelial growth forms (hyphae length ranges from a few cells to many yards)
 - Fungi actinomycetes, and oomycetes
 - Penetrate organic matter
 - Translocate nutrients
 - Functional roles include: Decomposers, mutualists, pathogens, predators (e.g., nematode-trapping fungi)
 - iii. Algae
 - Dominated by "blue-green" algae (Cyanophyta) and eukaryotic algae
 - Present where sunlight is available near soil surface, active when there is moisture available, too
 - Help bind soil particles together, reducing erosion potential (biological soil crusts)
 - Increase water retention capacity of soil through exudates
 - Often 1000 to 10,000 per g of soil
 - Functional roles: Primary producers (photosynthesizers), N fixers
 - b) Microfauna

Note: This section and the macrofauna section below are based on information from the European Atlas of Soil Biodiversity; see Resources for details

 - i. Protozoans (1/5000 inch to 1/50 inch wide)

- Small animals (acellular) living in water films
 - Encystment (hibernating in a cyst): Distinctive response to drying out
 - Inhabit transitory environments, so reproduce rapidly
 - Colpoda divide once or twice per day at 12°C
 - Several distinct types
 - Ciliates have fringe of small hairs used for locomotion
 - Amoebae have an amorphous body shape
 - Flagellates have a whip-like tail for locomotion
 - Functional roles: Predators (e.g., of bacteria, other microorganisms), decomposers (feed on detritus)
- ii. Nematodes (1/500 inch in diameter, 1/20 inch in length)
- Global distribution
 - Soil abundance = million/m²
 - Outer cuticle protects; resistant to toxins
 - Functional roles include: Microbivores, omnivores, predators, some parasites (10%)
 - Abundant at sites with high OM concentration
- iii. Rotifers (1/50 to 1/120 inch long)
- Multicellular, though still microscopic
 - Live in water films on moist soils; one of most abundant taxa in the top layer of soil or litter (32,000 to 2 million per m²)
 - Can undergo anhydrobiosis (survive drying down by forming a cyst)
 - Primary feeding strategies: Grazing the bacterial film on SOM or other particles or filter feeding on bacteria, yeast, and algae in the soil water
 - Functional roles: Herbivores (e.g., on algae), decomposers (feed on detritus)
- iv. Tardigrades (1/25 inch)
- Multicellular, though still microscopic
 - Terrestrial tardigrades live on moss or lichen
 - Can undergo anhydrobiosis (survive drying down by forming a tun)
 - Primary feeding strategies: Some use stylets to pierce moss, algae, protozoans, rotifers or nematodes and suck out fluids; others consume whole microfauna
 - Functional roles: Herbivores, predators
- v. Functional roles of microfauna do not include shredding of organic matter into smaller pieces
- c) Mesofauna
- i. Potworms (Enchytraeida, 1/50 to 2 inches long)
- Small annelids (related to earthworms)
 - Tolerate pH < 4
 - Thousands/m² in high organic matter soil
 - No burrows
 - Feed on fungal hyphae, microorganisms, feces
- ii. Collembolans (springtails, 1/100 to 4 inches long)
- Small arthropods (related to insects); with mites, the most numerous soil arthropods
 - Live in soil and leaf litter
 - Hundreds to thousands per handful of soil high in SOM
 - Feed on fungal hyphae, bacteria, detritus

- iii. Mites (acari, 1/125 to 1/30 inches long)
 - Small arachnids (related to spiders); with collembolans, the most numerous soil arthropods (1000 to 10,000 per m²)
 - Global distribution
 - Live in soil and in habitats with high quantities of OM
 - Primarily predators, feeding on collembola, nematodes, insect larvae
 - iv. Insect larvae
 - Fly (Diptera) larvae are probably the most important
 - In home compost systems, black soldier fly larvae (in the family Stratiomyidae, order Diptera) can play a key role in consuming organic matter, on par with earthworms
 - Diverse functional roles include: Predators, parasites, herbivores, decomposers (feeding on detritus)
 - v. Symphyla (1/125 to 1/30 inches)
 - Small soil-dwelling myriapods, related to millipedes and centipedes
 - Primarily eat decaying vegetation and microorganisms, but also seeds, roots, and root hairs in agroecosystems, thus damaging crops when they do
 - Up to 20,000 per m²
 - vi. Overall, mesofauna regulate microfauna (and other mesofauna!) by grazing
 - vii. Minor shredding of organic matter
 - viii. Total of 500 to 200,000 per square meter, far less abundant and with lower biomass than microfauna
- d) Macrofauna
- i. Earthworms (1/3 to 45 inches long)
 - 3 ecological types: Anecic—large, live in permanent burrows in the soil, feed on litter from the surface mixed with ingested soil; endogeic—small, live in temporary burrows in the soil, feed on rich soils to obtain nutrients from organic matter; epigeic—small, live at the soil surface in litter, feed on litter there
 - Obtain nutrition from partially decomposed organic matter and part from microbes living on the organic residues they ingest
 - Stimulate microbial activity through effects on SOM, microbial inoculation onto substrates, soil structure, etc.
 - Mix and aggregate soil
 - Increase water infiltration
 - Provide channels for root penetration deep into soil
 - Bury and shred organic matter
 - Abundance decreases after disturbance (tillage, chemicals)
 - ii. Myriapods
 - Millipedes (Diplopoda, 1/12 to 11 inches long) and centipedes (Chilopoda, 1/8 to 11 inches long)
 - Millipedes live in litter and upper layers of soil; some are shredders that feed on organic matter, others are predators on arthropods or earthworms, others pierce and suck plant cells. More common in soils high in calcium carbonate (e.g., from limestone); 15 to 800 per m².
 - Large species of centipedes live in litter or close to the soil surface, while small and narrow species of centipedes live in deeper soil layers. They are primarily generalist predators consuming insect adults and larvae, collembolans, mites, nematodes, potworms and earthworms, and occasionally leaf litter; 20-300 per m².

- iii. Isopods (woodlice, 1/15 to 2 inches long)
 - Crustaceans, related to lobsters and crabs
 - Live in leaf litter, in vegetation, under stones
 - Generally are decomposers, feeding on dead organic material, but sometimes are predators of bacteria, fungivores, or herbivores
- iv. Mollusks (snails and slugs, ¼ inch to 10 inches)
 - Live in damp soil conditions (although snails can hibernate for up to 4 years in dry conditions)
 - Most active at night or on cloudy, foggy days
 - Small component of soil fauna biomass but can be of high agronomic and ecological significance (especially when populations near ½ million per acre)
 - Primarily herbivores, especially of succulent foliage such as seedlings and fruit near the ground, but also detritivores
- v. Insects
 - Many insects live in or on the soil as larvae or adults, and thus fill many functional roles in the soil food web. Two examples include:
 - Ants: Ant diversity can be very high, with tens to hundreds of species in a few acres. Ants fulfill multiple trophic roles, e.g., herbivores, predators, scavengers, parasites.
 - Carabid beetles: Both larvae and adults may live in the soil. May be predators, e.g., feeding on snails or collembola, fungivores, frugivores (eating seeds), or herbivores.
- vi. Macrofauna shred and incorporate plant remains (may become pests by feeding on living plants if insufficient organic residues present)
- vii. Also alter the soil structure, e.g., by burrowing, mixing, defecating, and helping form soil aggregates
- e) Megafauna
 - i. Large invertebrates, vertebrates, including moles, mice, rabbits, gophers, snakes, and lizards
 - ii. Primary ecosystem engineers of the soil: Important for moving and turning soil, contributing to nutrient cycling, aeration, and drainage
 - iii. Fill a range of functional roles: Herbivores and predators of invertebrates and small vertebrates

F. Rhizosphere Ecology

1. Definitions

- a) Rhizosphere (**R**): The narrow zone of soil subject to the influence of living roots, as manifested by the leakage or exudation of substances that promote or inhibit microbial activity
- b) Rhizoplane (**r**): The actual root surface, which provides a highly favorable nutrient base for many species of bacteria, archaea and fungi
- c) Edaphosphere (**S**): Soil beyond root influence
- d) Rhizosphere Effect: Soil microorganisms are stimulated by the roots
 - i. **R:S** ratio generally greater than 1 (i.e., more biota in **R** than in **S**)
- e) Rhizosphere succession: The sequence of changes in the composition and densities of soil microbes and fauna in the area surrounding a growing root (see below)

2. Roots

a) Root environment

- i. Determined by above-ground processes (products of photosynthesis are translocated to roots)
- ii. Exudates (see below), sloughed hairs, and epidermal (root's surface) cells feed soil organisms in **R** and **r**
- iii. Plant roots also can release bicarbonate (HCO_3^-), which raises the soil pH. This can make some cations (e.g., Fe^{+3} , Ca^{+2} , Mg^{+2} , and K^{+1}) unavailable to plants. Irrigation water may also contain bicarbonate and affect soil pH and availability of some nutrients.
- iv. Oxygen decreases, CO_2 increases in root zone over time due to plant and **R** organism respiration

b) Root form

- i. Fibrous roots
 - Most monocots (e.g., grasses, corn)
 - Primary root replaced by series of adventitious roots
- ii. Tap roots
 - Most monocots and gymnosperms
 - Tap root persists and forms many lateral branches
- iii. Root depth
 - Species specific, influenced by environmental conditions

c) Root structure

- i. Root cap
 - Live cells produced by meristem
 - Protects root, like a bud scale
 - Constantly replaced (5–6 day turn over)
 - Responds to gravity
- ii. Meristematic zone: 2 mm (.08 inch) zone where most cell division happens
- iii. Zone of elongation: Rapid growth, cells from meristem
- iv. Mucilage
 - Covers root from tip to beginning of root hair zone
 - Secreted by root cap and epidermal cells
 - Possible functions: Lubricates and protects root as it grows through the soil, helps with nutrient uptake, prevents drying, fills spaces between root and soil and helps bind soil aggregates, food for microbes, including beneficial microbes
- v. Root hair (differentiation) zone
 - Are lateral outgrowths of single epidermal cells; microscopic
 - Root hairs have life span of days to weeks; rye plants can produce over 100 million per day
 - Do not become large structural roots, though help anchor the plant in the soil
 - Key role is improving nutrient absorption by increasing surface area for nutrient and water uptake. Root hairs make up the majority of root surface area.
 - Food sources that support rhizosphere microbes, contribute significant amounts of soil organic matter
- vi. Lateral roots
 - Originate from the vascular bundle inside the root cortex
 - Cortex and epidermis are ruptured by new lateral root
 - Bacteria colonize these emergence sites

- vii. Vascular bundle
 - Xylem and phloem in the root cortex
 - Connects roots to the rest of the plant, including for transport of photosynthetic products (sugars) to the roots and of water and nutrients from the soil up to the aboveground portion of the plant
 - Foliar sprays may move into roots (depends on molecular weight)
 - Herbicides, antibiotics may also move into roots
 - Streptomycin moved from Coleus leaves to roots in 24 hrs; bacteria in the rhizosphere were suppressed by the streptomycin
- d) Root nutrition
 - i. Maximum nutrient uptake occurs behind meristem (in the elongation and root hair zones)
 - ii. Water and nutrients are withdrawn from narrow band around roots
 - iii. Replenished from surrounding soil by mass flow (the movement of nutrients with the overall flow of water to plant roots); all ions in solution move towards root during mass flow
 - iv. If mass flow is slower than uptake, a depletion zone is created around the root, resulting in lack of some nutrients
 - v. If uptake is slower than mass flow for a particular ion (or even nonexistent if the ion is not used by the plant) certain ions may accumulate around the root
- e) Root exudates
 - i. Amounts
 - 20–50% more C enters the soil from exudates, sloughed cells, and root hairs than is present as fibrous roots at end of growing season = substantial contribution to SOM
 - Amount of exudates increased by:
 - Wetting, after a drying spell
 - Physical or chemical injury (e.g., mowing, grazing of perennial grass cover crop)
 - Abrasion, phytotoxic residues, osmotic stress
 - Amount of exudate varies with plant species and age, as well as the soil environment
 - ii. Types
 - Carbohydrates and amino acids: Most-researched components of exudates
 - 10 sugars, glucose and fructose most common
 - 25 amino acids
 - Also organic acids, fatty acids, sterols, enzymes, volatile compounds, and growth factors
 - Type of exudate varies with plant species, age, soil environment
 - Difficult to separate plant and microbe sources
 - iii. Exudates released from meristem zone
 - Nematodes and zoospores congregate there
- f) Management effects on rhizosphere
 - i. Synthetic fertilizers
 - Sometimes no effect
 - Sometimes increase **R:S** indirectly through stimulation of plant growth
 - ii. Organic manures
 - Same indirect positive effect on **R:S**

- Also may decrease **R:S** ratio since edaphic (**S**) microbes are also stimulated by organic matter input
 - After 4 weeks of decomposition, **R:S** generally increases
3. Soil organisms
- a) Bacteria and archaea
 - i. Most responsive to plant exudates
 - ii. 2 to 20 fold increase in bacterial populations in **R** vs. **S**
 - iii. Pseudomonas most consistently abundant in rhizosphere
 - iv. Also Rhizobium (some are used in DNA transfer as part of genetic engineering) and Achromobacter
 - v. Azotobacter, non-symbiotic nitrogen fixer
 - If inoculated on seed can persist in rhizosphere
 - vi. Rhizobium, Nitrosomonas, and Nitrobacter, all important to the nitrogen cycle (see ◀ Figure 2.10 in Unit 2.2), common in **R**
 - b) Fungi
 - i. Average increase of 10 to 20 fold in **R** of crop plants from **S**
 - ii. Fusarium is a dominant genera of **R** fungi
 - iii. Mycorrhizae can provide physical and chemical suppression of pathogens
 - c) Protozoans
 - i. Mainly bacteria grazers, so some increase is expected in **R**
 - ii. Example: In a wheat field, bacteria **R:S** was 23:1, protozoan **R:S** was 2:1
 - iii. Some large amoebae may provide biocontrol of some fungi
 - d) Nematodes
 - i. Root substances stimulate egg hatching of some parasitic nematodes
 - ii. Host and non-host plants may stimulate hatching of nematodes, e.g., some crucifers and chenopods stimulate Heterodera hatching, but don't support root invasion by larvae. Some plants will cause eggs of parasitic nematodes to hatch, but then are not susceptible to attack by the parasite. Therefore the plant stays healthy, and the nematodes fail to thrive.
 - iii. Nematodes tend to congregate around elongation zone of roots
 - iv. Degree of nematode attraction is proportional to root growth rate
 - v. Some root exudates repel nematodes (e.g., isothiocyanates in mustard)
 - e) Microarthropods
 - i. Some grazers consistently more abundant around roots
 - f) Rhizosphere succession
 - i. Root tip releases labile carbon
 - ii. Labile carbon stimulates rapid increase of microbes and thus nutrient immobilization in **R**
 - iii. Grazers increase, tracking the microbe population increases
 - iv. Water and carbon in root hair zone decrease
 - v. Microbes eventually decrease; grazers cause net mineralization and release of nutrients from SOM
 - vi. Later, grazers encyst or migrate

G. Management Effects on Soil Ecosystems

1. No-tillage or reduced-tillage cropping systems
 - a) Organic litter is retained on the soil surface
 - b) Physical disturbance is minimized
 - c) Surface soil stays cooler and moister
 - d) More surface organic matter available as food substrate
 - e) Ratio of fungi to bacteria increases over time
 - f) Earthworms and arthropods become more plentiful
 - g) Effects on nutrient cycling: May increase total soil N, improve N use efficiency of plants, but may increase N₂O emissions
 - h) Effects on soil physical properties: May increase SOM and aggregation
2. Rotations
 - a) Monocultures and clean cultivation
 - i. Create little habitat for soil organisms, leading to less abundant and diverse soil ecosystems
 - ii. Consistent plant hosts may serve to develop populations of pathogenic organisms, causing pest problems and crop losses that facilitate the need for pesticide use.
 - b) Complex rotations
 - i. Result in greater variety of microbial food sources (roots, root exudates, and residues)
 - ii. Increase diversity of soil organisms, leading to increased competition for resources, as well as predation of pathogens and pests
 - iii. Interrupt plant-host pest cycles
 - c) Multiculture or polyculture
 - i. Growing more than one crop in one field
 - ii. More closely mimics natural ecosystem
 - iii. Likely to support even greater diversity of soil organisms, especially invertebrates
 - iv. Also interrupts plant-host pest cycles
3. Biocides (insecticides, herbicides, fungicides)
 - a) Effects vary depending on:
 - i. Type of chemical
 - ii. Species of soil organism in question
 - iii. Concentration and other exposure factors
 - b) High levels of pesticide use generally reduce food web complexity
 - i. Methyl bromide and other fumigants are extreme examples, resulting in temporary soil sterilization
 - ii. Eliminate most organisms
 - iii. Some bacteria quickly return
 - iv. Other organisms only slowly return
 - c) Biocides and predator-release phenomenon
 - i. In cases where biocides selectively eliminate predators, lower trophic levels may become more abundant
 - ii. Destabilizing effect on food webs
 - Overgrazing on food sources results in depletion of food sources
 - Population explosion, followed by crash

- Immobilization of nutrients, followed by rapid mineralization at a rate that is not necessarily compatible with crop needs. May result in leaching of water-soluble nutrients, especially forms of N.
- d) Earthworms
- i. Most strongly affected (negatively) by fungicides and fumigants
 - ii. Herbicides
 - Don't seem to be directly toxic to earthworms
 - Indirect negative effect through elimination of vegetation
4. Food web structures
- a) Fungi/bacteria ratio
 - b) Dominant microbe influences other trophic levels
5. Interaction with fertility needs (also see Unit 1.1)
- a) Measures of available nitrogen
 - i. Conventional cropping systems
 - Most N provided by additions of fertilizer
 - Measurements of nitrate reflect accurately (but highly temporally) what is available to plants
 - Key management decisions are when to apply fertilizer
 - ii. Cropping systems based on organic matter management
 - Soil food web becomes primary source of N derived from organic matter inputs
 - Soil analysis in efficiently managed farming systems may indicate "inadequate" levels of N at any given time because much of soil N is immobilized
 - Cumulative release of mineral N over growing season may match amounts seen in conventional system
 - Managing the timing of mineralization (through tillage, OM quality [e.g., C:N ratio], incorporation of high-OM nutrient amendments, irrigation) by soil food web becomes more critical
 - If managed well, less risk of nutrient loss through leaching or volatilization

Demonstration 1: Organic Matter Decomposition in Litter Bags

for the instructor

OVERVIEW

To demonstrate the capacity of different soils to decompose organic matter, this exercise requires you to bury cellulose disks (Whatman filter paper) in a variety of locations. This should be done at least two weeks prior to the class to allow decomposition to proceed before the disks are retrieved on the day of the class. To accelerate decomposition, filter paper disks can be dipped in a bucket of water with some fish emulsion added just before burial.

MATERIALS NEEDED

- Whatman filter paper discs
- Plastic mesh bags[†]
- Flags to mark burial sites
- Flat shovel
- Litter Bag Data Sheet (see Appendix 2)
- Pencils

[†] For plastic mesh bags, you may use pond and pool netting obtained from a local feed and seed supply. It is a 3/8-inch polypropylene mesh. Cut the mesh into 6-inch x 12-inch pieces, fold in half, then fold the edges over and staple the edges shut. Other sources are the mesh bags that bulbs are sold in, garlic or onion bags, or the mesh bags that imported rice noodles are packed in. The smaller the mesh size, the smaller the organisms that will be excluded from the bag. This feature can be exploited by comparing decomposition rates of organic matter buried in bags of different mesh sizes. Organic matter in bags with very fine mesh will be decomposed primarily by microflora and microfauna. Organic matter in larger mesh bags will also be decomposed by larger fauna.

PREPARATION

1. Place litter bags in soil at least two weeks prior to class. Place them vertically in soil and all at the same depth. For a 10 cm disc, 0 to 10 cm is a convenient depth.
2. Flag each site, and make a note of the burial locations. A minimum of 3 bags should be placed in each habitat. Possible habitats include raised garden beds, cultivated fields, fallow fields, orchards, compost piles, vermicompost bins, weedy borders, and on the soil surface (not buried).

PROCEDURE

1. After two weeks, bring students out to the sites and ask them to observe the biotic, abiotic, and human management elements of the soil habitat that each bag was in, noting features such as relative soil moisture, presence or evidence (e.g., burrows or tunnels) of any soil organisms, vegetative cover and shading, and prior cultivation.
2. Students or the instructor can unbury the bags. This should be done very gently, as the paper is likely to be very fragile. (If too rapid decomposition makes this demonstration difficult, an alternative material to use is a 50/50 cotton/polyester fabric. Even if the cotton is entirely degraded, the polyester matrix will remain intact. Strips would have to be weighed before and after burial to determine mass loss.)
3. Gently brush soil from discs. Ask students to visually estimate the percentage of the disc remaining. You may wish to provide a sheet showing examples of visual estimates of percentages, e.g., to help standardize results.
4. Record results and calculate the average percentage of the disc remaining for each habitat selected. A sample form is provided (see Appendix 2, Litter Bag Data Sheet) for recording data. Appendix 3 provides an example of a filled-out data sheet.

PREPARATION TIME

1 hour to make 24 bags, 1 hour to bury 24 bags
(allow additional time for gathering materials)

DEMONSTRATION TIME

1.5 hours

DISCUSSION QUESTIONS

1. After retrieving the litter bags, ask students to offer hypotheses about why the disks decompose more rapidly in some habitats than others.
2. What environmental factors might have influenced the results?
3. What management factors might have influenced the results?
4. Can you see any signs of biological activity on the disks (e.g., fungal mycelia, soil animals, invertebrate feces, comminution)?
5. What do the results suggest about nutrient cycling rates in the soils tested?
6. Can these observations for cellulose decomposition rates be extrapolated to other types of organic matter?
7. What are the limitations of this method?

VARIATIONS

If possible, pair the litter bag demonstration with other methods of assessing biological activity, such as:

- Carbon dioxide evolution (see Demonstration 2, Soil Respiration)
- Earthworm density (see Demonstration 3, Earthworm Populations)
- Tullgren funnel extractions of microarthropods (see Demonstration 4, Soil Arthropods)
- Microbial biomass measurements (this generally requires more extensive lab work, but you might check with local agricultural or ecological researchers to see if anyone doing similar work could accommodate a few samples and help your students analyze the results)

Demonstration 1: Organic Matter Decomposition in Litter Bags

step-by-step instructions for students

INTRODUCTION

The decomposition of organic matter is an important soil process for organically managed farms and gardens. Organic matter includes a vast array of compounds that are biologically decomposed at various rates, depending on the compounds' physical and chemical complexity. Physical factors such as temperature and moisture as well as biological factors such as activity of soil organisms heavily influence decomposition rates, and are all influenced by management practices.

We can use discs of filter paper to represent uniform pieces of cellulose-rich organic matter. If discs are placed in the soil for a set period and then retrieved, we can begin to understand the capacity of various soils to decompose cellulose. By placing the discs in plastic mesh bags prior to putting them in the soil, we make it easier to retrieve the discs intact. Decomposition can be estimated by a visual estimate of percentage surface area remaining. A more quantitative method is to weigh the discs prior to putting them in the field, then collecting them, rinsing them, drying them (e.g., in a drying oven) and reweighing them to estimate mass loss.

MATERIALS NEEDED

- Whatman filter paper discs
- Plastic mesh bags
- Stake wire marking flags
- Flat shovel
- Litter Bag Data Sheet (see Appendix 2)
- Pencils

PREPARATION

1. Litter bags, each consisting of a filter paper disc placed inside a plastic mesh bag, were placed in soil at least two weeks prior to this class. They were placed vertically in the soil, all at the same depth. For a 10 cm disc, 0 to 10 cm is a convenient depth, but your instructor will tell you the actual depth used.

Depth of litter bags: _____.

PROCEDURE

1. With your instructor, visit each site where the litter bags have been buried. At each site, observe the biotic, abiotic, and human management elements of the soil habitat that each bag was in.
 - What is the relative soil moisture at each site? Is it damp, dry, or in between?
 - Do you see any presence or evidence of any soil organisms? Are there burrows or tunnels, and if so, are they large or small? What kind of organisms might be using them?
 - Is there vegetative cover of the soil? If so, what kind (grasses, broad-leaf plants, woody shrubs, weeds, crops) and what size (overhead, several feet, close to the ground)? Do the plants shade the soil?
 - Is there evidence of prior or current cultivation?
2. Unbury the litter bags. This should be done very gently, as the paper is likely to be very fragile.
3. Gently brush soil from discs. Visually estimate the percentage of the disc remaining.

4. Record results and calculate the average percentage of the disc remaining for each habitat, using the data sheet supplied.n.

DISCUSSION QUESTIONS

1. After retrieving the litter bags, ask students to offer hypotheses about why the disks decompose more rapidly in some habitats than others:
 - a. *What environmental factors might have influenced the results?*
 - b. *What management factors might have influenced the results?*
 - c. *Can you see any signs of biological activity on the disks (e.g., fungal mycelia, soil animals, invertebrate feces)?*
2. What do the results suggest about nutrient cycling rates in the soils tested?
3. Can these observations for cellulose decomposition rates be extrapolated to other types of organic matter?
4. What are the limitations of this method?

Demonstration 2: Soil Respiration

for the instructor

OVERVIEW

Soil microbes breathe in oxygen and breathe out carbon dioxide; using Draeger gas detection tubes to measure the carbon dioxide output gives an indication of the relative activity of the microbes. The brief instructions below point the instructor to comprehensive directions in the Soil Quality Test Kit Guide published by the NRCS: www.nrcs.usda.gov/wps/portal/nrcs/detail/soils/health/assessment/?cid=nrcs142p2_053873. Follow the link to Soil Respiration Test for directions and photos.

MATERIALS

See Soil Respiration Test in the NRCS Soil Quality Test Kit Guide for the full list. Among more common items such as a soil thermometer and stopwatch, you will also need to construct 6-inch diameter rings with fitted lids that have holes with stoppers, allowing equipment such as soil thermometers and Draeger tubes to be inserted. The Draeger tubes will need to be specially ordered, e.g., from a scientific supply company (see Sources of Supplies at the end of this outline). Students may record measurements in the Soil Respiration Data Sheet in Appendix 4.

PREPARATION

Here, too, see the Soil Respiration Test (see directions in the Soil Quality Test Kit Guide: www.nrcs.usda.gov/wps/portal/nrcs/detail/soils/health/assessment/?cid=nrcs142p2_053873). Follow the link to *Soil Respiration Test* for directions and photos for the complete preparation needed for the demonstration. In addition to gathering and constructing materials, the site will need to be brought to proper soil moisture. From the test guide: “Microbial activity is greatest when the soil is moist (at or near field capacity). If the soil is dry, a second respiration measurement should be made at a minimum of six hours (preferably 16 to 24 hours later) after the infiltration test or wetting of the soil. If the soil is saturated, soil respiration is inhibited, and this test should not be run.” To save time during the demonstration, rings can be placed and soils wetted the previous day. It may be useful to combine the litter bag (demonstration 1) and soil respiration measurements, allowing students to compare results from two different methods of measuring soil biological activity.

Locate best sites to use before the demonstration. As with the litter bag demonstration, select a variety of habitats to test, such as raised garden beds, cultivated fields, fallow fields, orchards, compost piles, vermicompost bins, and weedy borders.

PROCEDURE

Divide class in teams of two or more, and assign each team to one sample site. Demonstrate the technique first using equipment prepared at different stages, à la Julia Child. Use one ring to show how rings should be placed and head-space measurements taken. Have a second ring already

placed and capped so you can demonstrate how to collect a CO₂ sample. Then send teams out to do their own sampling, using the Soil Respiration Data Sheet (Appendix 4) to record their measurements.

See the Soil Respiration Test (online) for details on how to perform the tests, including preparing the sample area, inserting the rings in the soil, preparing the rings for measurement, taking the measurements, and using the Draeger tubes.

CALCULATIONS

Soil Respiration (lb CO₂ - C/acre/day) =
PF × TF × (%CO₂ - 0.035) × 22.91 × H

PF = pressure factor = 1

TF = temperature factor = (soil temperature in Celsius + 273) ÷ 273

H = inside height of ring = 5.08 cm (2 inches)

If a laptop is available in the field, students can enter the data into a spreadsheet and do these calculations. Calculators could also be used with printed spreadsheets in the field.

PREPARATION TIME

1–2 hours (varies depending on what materials are available)

DEMONSTRATION TIME

1–1.5 hours

DISCUSSION QUESTIONS

1. Compare soil respiration results for different sites. How may management practices on the different sites have influenced results?
2. If measurements were made before and after wetting soil, compare before and after results. How does soil moisture influence biological activity?
3. Would it be possible to estimate all carbon imports and exports to a soil ecosystem? What information would you need to start to make such an estimate?

SOURCES OF SUPPLIES

Draeger tubes, latex tubing, hypodermic needles:

Fisher Scientific, Pittsburgh, PA
www.fishersci.com
(800) 766-7000

Draeger tubes:

Scientific Industries
2207 Blue Bell Ave. Boulder, CO 80302
(303) 443-7087

Demonstration 2: Soil Respiration

step-by-step instructions for students

INTRODUCTION

Soil is alive, teeming with organisms that are eating, growing, breathing, and reproducing. Many of these organisms, from microorganisms such as bacteria and archaea, to macroorganisms such as earthworms and insects, and even plant roots, take in oxygen (O₂) and release carbon dioxide (CO₂). The release of CO₂ from the soil is called soil respiration and is a key component of healthy agroecosystems.

Soil respiration can be limited by soil moisture, temperature, and oxygen availability. Optimal respiration rates usually occur around 60% of water-filled pore space, with lower rates when the soil is either dry or saturated with water. Biological activity doubles for every 18°F rise in temperature until the optimal temperature is reached, although this optimum level varies for different organisms. Activity then declines as temperature rises above optimum. The most efficient soil organic matter decomposers are aerobic, so soil respiration rates are highest where there is high O₂ availability, such as in well-aggregated soil with many macropores, and decline when O₂ concentrations are low, as in soils that are saturated with water. Note that soil respiration is highly variable both spatially and seasonally, especially as soil moisture, temperature, and oxygen availability change, so it's important to keep these factors in mind when interpreting your results.

Soil respiration also depends on the availability of decomposable organic substrates, that is, all the bits of organic matter of various sizes that are food for micro- and macroorganisms. Additions of organic materials will generally increase soil respiration. Organic materials with low carbon to nitrogen (C:N) ratios (e.g., manure, leguminous cover crops) are easily decomposed, so the addition of these materials to soil will increase soil respiration quickly. Materials with high C:N ratios (e.g., compost, sawdust) decompose more slowly but provide a more stable, long-term supply of organic material than legumes and manure. C:N that is too high has drawbacks: Soil microbes will compete with crop plants for the limited nitrogen supply when soil is amended with products having C:N ratios higher than 25:1.

The history of the sampling site is also important. Tillage or cultivation loosens the soil and creates better O₂ accessibility, increasing decomposition of organic matter and respiration rates. However, high respiration rates without adequate replenishing of organic materials can result in net loss of soil carbon. Use of agricultural chemicals that directly kill or otherwise impair soil microorganisms, such as fungicides and nematocides, on the site is also important to consider. Although these pesticides target pathogenic organisms, they may also impair the beneficial organisms and temporarily decrease soil respiration.

Management factors influencing soil respiration

INCREASES SOIL RESPIRATION

- Adding organic amendments, such as cover crops, composts (including composted manure), and crop residues
- Irrigating to proper moisture content
- Tillage

DECREASES SOIL RESPIRATION

- Removing or burning crop residues
- Continuous tillage without organic matter replacement
- Chemical pesticides (e.g., fungicides and nematocides)

MATERIALS

Soil Respiration Test in the NRCS Soil Quality Test Kit Guide Procedure

Follow the instructions from the Soil Respiration Test, as provided by your instructor.

CALCULATIONS:

$$\text{Soil Respiration (lb CO}_2\text{-C/acre/day)} = \text{PF} \times \text{TF} \times (\% \text{CO}_2 - 0.035) \times 22.91 \times \text{H}$$

$$\text{PF} = \text{pressure factor} = 1$$

$$\text{TF} = \text{temperature factor} = (\text{soil temperature in Celsius} + 273) \div 273$$

$$\text{H} = \text{inside height of ring} = 5.08 \text{ cm (2 inches) if not measured}$$

Interpretation of soil respiration values

In general, a higher respiration rate indicates better soil quality. A high soil respiration rate, indicative of high bio-logical activity, can be a good sign of rapid decomposition of organic residues into nutrients available for plant growth. A low respiration rate, when soil temperature and moisture are favorable for biological activity, would indicate too little organic matter input (i.e., the soil organisms have too little organic matter to consume). Some general guidelines to interpreting respiration values are presented in ► Table 2.13. These are only guidelines and should not be applied to every soil type and management situation.

► **TABLE 2.13** | GENERAL SOIL RESPIRATION CLASS RATINGS AND SOIL CONDITION AT OPTIMUM SOIL TEMPERATURE AND MOISTURE CONDITIONS, PRIMARILY FOR AGRICULTURAL LAND USES (Woods End Research, 1997)

SOIL RESPIRATION (lbs. CO ₂ -C/ac/day)	CLASS	SOIL CONDITION
0	No soil activity	Soil has no biological activity and is virtually sterile
< 9.5	Very low soil activity	Soil is very depleted of available organic matter and has little biological activity
9.5 – 16	Moderately low soil activity	Soil is somewhat depleted of available organic matter, and biological activity is low
16 – 32	Medium soil activity	Soil is approaching or declining from an ideal state of biological activity
32 – 64	Ideal soil activity	Soil is in an ideal state of biological activity and has adequate organic matter and active populations of microorganisms
> 64	Unusually high soil activity	Soil has a very high level of microbial activity and has high levels of available organic matter, possibly from the addition of large quantities of fresh organic matter or manure

These guidelines are rules of thumb, but the soil respiration rate must be interpreted within the context of other indicators. For example, if the soil has very low nitrate concentrations and high respiration rates, there may be high nitrogen immobilization (when microbes bind up nitrogen in organic forms, so it's not available to other organisms, such as plants); this can result from adding soil amendments that have high C:N ratios.

Similarly, as mentioned in the introduction, high respiration rates without adequate input of organic matter can indicate too much decomposition, leading to a decrease in the stable component of soil organic matter. This then decreases the key properties of soil organic matter, such as aggregation, cation exchange, and water holding capacity, that make it such an important part of soil health. High respiration rates can happen immediately following a tillage operation, due to exposure of organic matter to organisms and oxygen, as well as after rainfall. The increase in soil respiration is affected by the length of time the soil is dry before the rainfall event.

Spatial differences, even on a small scale, are helpful to consider in interpreting soil respiration rates. Under dry conditions, soil respiration tends to be higher in the crop row than between the rows, due to respiration from the crop roots. This difference disappears during wet conditions, when pore space is filled and oxygen availability drops in both microhabitats. However, when the soil between rows has been compacted (e.g., by wheels) and the soil is wet, soil respiration tends to be lower than in the row, because of lower soil porosity under compaction.

DISCUSSION QUESTIONS

1. Compare soil respiration results for different sites. How may management practices on the different sites influence results?
2. If measurements were made before and after wetting soil, compare the before and after results. How does soil moisture influence biological activity?
3. Would it be possible to estimate all carbon imports and exports to a soil ecosystem? What information would you need to start to make such an estimate?

Demonstration 3: Assessing Earthworm Populations as Indicators of Soil Quality

for the instructor

OVERVIEW

This demonstration introduces students to techniques for assessing earthworm populations as indicators of soil quality.

You have a choice of two methods for this demonstration. The shovel-count method will be more tedious for the students because they will have to sort through the soil and remove all earthworms. The vermifuge method may take a little more effort at first to gather the materials needed, but it will make the students' work easier.

MATERIALS

SHOVEL-COUNT METHOD

- Shovels
- Earthworm Data Sheet (Appendix 5)
- Pencils

VERMIFUGE METHOD

- Sample rings[†]
- Clippers
- Watering can
- Scoop
- Stirring rod
- Fresh water
- Jars
- Earthworm Data Sheet (Appendix 5)
- Pencils
- Ground yellow mustard seed (available in bulk from health food stores or from herb companies)[‡]

[†]Sample rings define the sample area and prevent vermifuge from escaping sample area. A simple design is to cut the top 8–12 inches from a 5-gallon drum and weld on a piece of metal pipe that overhangs each side by 6 inches to use as a handle. The ring is pressed into the soil to 2–3 inches depth, and vermifuge is added within the sample ring. Sample rings can also be fashioned from sheet metal, housing duct pipes, or large clean paint cans with the bottom cut off.

[‡]60 ml (volume) or 32 grams of yellow mustard powder to 4.5 liters of tap water = 13 ml/1 liter or 7g/liter.

4.5 liters of vermifuge is the amount required per sample area in this demonstration.

PREPARATION

SHOVEL-COUNT METHOD

For the shovel-count method, very little preparation is required. Identify sample areas, try to collect a similar soil volume at each location, and record results.

VERMIFUGE METHOD

The vermifuge method requires more preparation. Sample rings must be obtained or made. Other materials must be gathered. To minimize the amount of time needed for the demonstration, sample rings can be set out the day before. Ideally a minimum of 4 can be set out per habitat. Select areas with contrasting management regimes. Possible habitats include orchard, row crop, fallow, and uncultivated field soils.

To begin the demonstration, gather group at one sample ring to explain technique. Divide class evenly among the number of sample rings and have each “ring-team” collect their sample. Have one person in each team do a shovel-count at each site for comparison. Collect results and derive an average abundance per habitat. Observe species differences and discuss results.

PROCEDURE

1. Select sample area.
2. Place sample rings on the surface of the site and push them several inches into the soil.
3. Carefully clip vegetation and removed all litter from inside sample area.
4. Slowly sprinkle 4.5 liters of vermifuge into each sample area, distributing it evenly over the entire surface.
5. After all of the vermifuge solution infiltrates the soil, wait 10 minutes, and make a second vermifuge application (4.5 liters).
6. Collect all earthworms that surface inside the sample area.
7. After 10 minutes elapse since infiltration of the second vermifuge application, use a hand spade to dig through the surface layer of soil (~5 cm deep) and collected any more earthworms found there.

8. Rinse earthworms in water, drain, and store in containers inside an insulated cooler with ice packs (unless samples are to be counted in the field and returned to the sample area).
9. An alternate method that does not require a sample ring can be found in the USDA Soil Quality Test Kit Guide, which is available on the internet (see Resources section).

PREPARATION TIME

For the shovel-count method, 0.5 hour is all that is needed. For the vermifuge method, several hours or more may needed to gather materials.

DEMONSTRATION TIME

1.5–2 hours

DISCUSSION QUESTIONS

1. Most earthworm species found in farmed soils in the U.S. were not present in those soils 400 years ago. Where do you think they came from?
2. Compare your findings from different habitats. Which habitats had the most earthworms per sample area? Which had the highest diversity (greatest number of species)? Why?
3. Determine what ecological types of earthworm were present in each sample area (see ► Table 2.13, page 2-114). How do you think these results were influenced by soil management practices in those areas. Consider factors such as amount and type of soil disturbance, organic matter inputs, presence of surface organic layer, etc.
4. How do these findings relate to agricultural productivity and sustainability?
5. If you were in charge of management decisions for the farm soils that were sampled, would you alter any practices based on this information? Why?

Demonstration 3: Assessing Earthworm Populations as Indicators of Soil Quality

step-by-step instructions for students

INTRODUCTION

Earthworms are representative of the many organisms that make up soil food webs, and their abundance can be an indicator of soil biological activity.

There are a number of ways to estimate how many earthworms are living in a particular field. Perhaps the simplest is the shovel-count: turn over a shovel-full of soil and count the worms present. Dig down 8 inches to a foot, and count every earthworm you can find in the shovel-full. Do this in half-a-dozen or more spots in each soil type on your land and come up with an average for each. If you find 5 to 10 worms per shovel-full, that represents a fairly healthy earthworm community. If this is done at about the same time each year the results will give some indication of how management practices are affecting earthworm populations.

Keep in mind that earthworm populations are very patchily distributed, and their location and abundance are heavily influenced by soil moisture, temperature, organic matter, time of year, and probably several other variables such as barometric pressure. For these reasons, a sufficient number of samples must be collected in order to accurately characterize earthworm populations in a particular field. Using more standardized sampling methods may also help.

Another method for sampling earthworms uses a vermifuge, or chemical irritant, which causes the earthworms to burrow to the soil surface, where they can be collected by hand. For many years the standard vermifuge has been a very dilute solution of formalin (about 8 ml formalin in 4.5 liters of water). However, recent studies have shown that mustard powder in water can be equally as effective.

Those interested in developing an even greater depth of understanding about earthworm ecology and how it interacts with farming may want to do more than just count numbers of earthworms present. Earthworms can be classified according to some simple physical characteristics that are directly related to their ecological roles in soil. ► Table 2.14 (next page) highlights the three types of earthworms.

Try using ► Table 2.14 to determine if you have more than one type of earthworm in your samples. Most California farm soils have endogeic earthworms, but epigeic and anecic species are rare. Epigeic species are more likely to be found in fields that have a permanent organic mulch on the surface. They may be added along with composts, but are not likely to thrive in the absence of an organic cover. Anecic species are desirable because of the work they do incorporating organic matter into the soil, mixing surface and deeper soil horizons, and creating deep channels for aeration, infiltration, and easy root penetration. Anecic earthworms could be introduced by direct inoculation, but transferring blocks of soil (one cubic foot each) from an area with a large earthworm population into a farm soil might work better.

Another idea is to set aside a small portion of a farm to be managed as an earthworm reservoir. If needed, the soil could be limed to bring it near pH 7, fertilized, irrigated regularly, and a cover crop established and cut periodically to provide an organic mulch as food and cover. A population of an anecic species could be introduced into this area and built up. Nightcrawlers can be purchased from bait dealers, who generally get them from nightcrawler harvesters in the Pacific Northwest.

From this reservoir, blocks could periodically be taken and introduced into the field. This might be done each year in the fall when earthworm activity is increasing. Remember to provide an organic mulch. The rate of spread would vary with species and conditions in the field. *Lumbricus terrestris*, the nightcrawler, is capable of traveling at least 19 meters (62 feet) on the soil surface in the course of one evening foray.

MATERIALS NEEDED

Assemble materials as per instructor's outline

SHOVEL-COUNT METHOD

1. For the shovel-count method, very little preparation is required. Identify sample areas, try to collect a similar soil volume at each location, and record results.

VERMIFUGE METHOD

1. Select sample area
2. Place sample rings on the surface of the site and push them several inches into the soil.
3. Carefully clip vegetation and removed all litter from inside sample area.
4. Slowly sprinkle 4.5 liters of vermifuge into each sample area, distributing it evenly over the entire surface.

5. After all of the vermifuge solution infiltrates the soil, wait 10 minutes, and make a second vermifuge application (4.5 liters).
6. Collect all earthworms that surface inside the sample area.
7. After 10 minutes elapse since infiltration of the second vermifuge application, use a hand spade to dig through the surface layer of soil (~5 cm deep) and collected any more earthworms found there.
8. Rinse earthworms in water, drain, and store in containers inside an insulated cooler with ice packs (unless samples are to be counted in the field and returned to the sample area).
9. An alternate method that does not require a sample ring can be found in the USDA Soil Quality Test Kit Guide, which is available in the internet (see Resources section).

► **TABLE 2.14** | THREE DIFFERENT TYPES OF EARTHWORMS

GROUP	WHAT THEY LOOK LIKE	WHERE THEY LIVE	WHAT THEY EAT	MEANING OF NAME	EXAMPLE
Epigeic	small; dark red or brown; fast growing move quickly	areas with a lot of organic matter: forest litter layer; manure piles; cool compost piles	large proportion of diet is organic matter	epi = on Gaia = earth	<i>Lumbricus rubella</i> , <i>Eisenia fetida</i> (red worm, manure worm)
Endogeic	small to medium; light or no pigmentation; slower moving	continous burrows in soil; often found in root ball; generally feed and defecate below ground	mixture of buried organic matter and mineral soil, decaying roots	endo = within Gaia = earth	<i>Allolobophora chlorotica</i> , <i>Aporrectodea caliginosa</i>
Anecic	large and very muscular; wedge-shaped tail; color on front end, less on tail end; slow growing	build permanent, vertical burrows that are very deep; raised midden of castings and residue marks burrow entrance	feed by pulling organic matter from surface down into burrow before ingesting	unknown	<i>Aporrectodea longa</i> <i>Lumbricus terrestris</i> (night-crawler)

A visual guide to these three types of earthworms can be found here:
www.nrri.umn.edu/worms/identification/ecology_groups.html

Demonstration 4: Soil Arthropods

for the instructor

OVERVIEW

This demonstration introduces students to techniques for sampling soil arthropods and familiarizes them with their functional roles.

For this short demonstration, both of these exercises provide a hands-on, show-and-tell of soil arthropods. You should have identification keys available, and some familiarity with what kinds of animals students are likely to find.

A pitfall trap is buried so the top sits flush with the soil surface, allowing surface-dwelling arthropods to fall in. Preserving liquid can be used in the bottom of the trap to keep the arthropods there for easy removal and identification. A Tullgren funnel uses light to dry out a soil or compost sample, driving out organisms so they can be collected and identified.

MATERIALS

PITFALL TRAPPING

- Cups (e.g., 500 or 1000 ml plastic drink cups; 1 per trap if one-time installation, or 2 per trap if you wish to repeat the trapping)
- Trowel
- (Optional) Preserving agent, e.g., ethanol or propylene glycol, especially for demonstrations that will run several days or more from start to finish. You need enough for 5-10 cm in the bottom of each trap.

TULLGREN FUNNELS

- Funnels (1 for each Tullgren funnel set-up)[†]
- Light source (4 to 40 watt —7 watt “Christmas” style lights work well; each funnel needs its own light source)
- Aluminum foil (if light source does not have a shade for focusing the heat on the sample)
- Screen (1 piece per funnel)[‡]
- Jars (1 per funnel)
- Ethanol or propylene glycol. You need enough for 10–20 cm in the jar below the funnel.

[†] Steep-sided funnels with no seams work well; inverted soda bottles work, and inverted polypropylene Erlenmeyer flasks with bottoms removed are excellent. Use 500 ml flasks for 5 × 5 cm soil cores, and 2000 ml flasks for compost or litter samples.

[‡] Examples for screen material are fine hardware cloth or plastic needlework backing—it should be fine enough to allow small organisms to pass through (e.g., less than 1-cm openings). The screen should be trimmed to fit across the mouth of or in the middle the funnel, as its role is to hold the sample in place in the funnel while it dries out.

FOR BOTH METHODS

- Dissection microscopes or hand lenses
- Identification guide, e.g., www.cals.ncsu.edu/course/ent525/soil/soilpix/index.html
- Soil Arthropod Data Sheet (Appendix 6)

PREPARATION

PITFALL TRAPPING

Select sampling areas in different habitats. Try for a minimum of 3 or 4 samples per habitat. Traps can be set 24 to 48 hours in advance of the demonstration. Traps can also be collected before the demonstration if time is at a minimum, although it will help students contextualize their results if they can see where and how the traps were set.

At each sampling site, bury a cup so that the top edge is flush with the soil surface; to help prevent the cup from filling with soil, you can bury two cups together, one inside the other, and then remove the top cup to have a clear working cup below. If you are using two cups for your trap, set the lower one down enough so the top cup is flush with the soil surface. The top of the cup may be left open, covered with hardware cloth, or covered with a board, leaving enough room between the board and pitfall trap for free access by surface roaming creatures (e.g., by propping the board up with a stone under each side).

If collected frequently, pitfalls may be left empty so that live specimens are obtained. You may also obtain specimens by adding 5–10 cm of soapy water in the bottom of the trap, or by using a preservative such as 70% ethanol (rubbing alcohol mixed 7:3 with water) or propylene glycol (“non-toxic” antifreeze). Preservatives help ensure the organisms do not eat one another; propylene glycol has the added benefit of not evaporating.

TULLGREN FUNNELS

Collect samples from various habitats. You can use soil cores (approx. 5×5 cm²), decomposing leaf litter, or compost.

Set up one Tullgren funnel for each sample. Place a piece of screen across the mouth of or part-way down a funnel. Carefully place the sample on the screen. If too much sample material falls through the funnel, add more screens, or a piece of coarse cheesecloth below the funnel. Place a wide-mouth jar with 10–20 cm of 70% ethanol or of propylene glycol under the funnel—this is where the organisms will be collected. Place the light source above the funnel, with the light above, but not touching, the sample. Do not shake or disturb funnels, keeping the sample jars as free of soil as possible. Let samples stand in funnels with the lights on for 5–7 days.

Samples can be collected and extracted in advance of the demonstration, although as with pitfall traps, it will help students contextualize their results if they can see how the samples were collected and how the Tullgren funnels work.

PROCEDURE

Observe the collected arthropods under magnification, either with dissecting scopes or hand lenses. If live collections are made from the pitfall traps, students can observe behavioral adaptations of the animals (e.g., springing springtails, fast-moving predators like centipedes and mesostigmatid mites, and slower-moving fungal grazers like oribatid mites and millipedes). Have simple keys available for help with identification. For a quantification exercise, have students count species or functional groups and calculate a diversity index, e.g., the Shannon index (see here: www.tiem.utk.edu/~gross/bioed/bealsmodules/shannonDI.html) or Simpson’s index, to compare habitats.

PREPARATION TIME

2 hours to 7 days, depending on which exercises are followed (less time generally for the pitfall trap, more for the Tullgren funnel) and what materials are available or need to be obtained.

DEMONSTRATION TIME

From 0.5 hour for a brief show-and-tell, where students observe samples previously collected, to 1 to 2 hours if students are involved in collecting samples, observing, and quantifying.

DISCUSSION QUESTIONS

1. Can you guess which animals might be predators? Which ones might be grazers? What about their shape indicates their functional group, that is, how they feed?
2. What effects do each habitat have on the soil organisms found there? Think about the sizes of creatures, diversity, food-web interactions, and pigmentation.
3. Which habitats had the greatest abundance? Which had the greatest diversity? Why?
4. What effects do you think different soil management practices have on soil arthropods? Besides the various effects of organic matter inputs, think about the influence of physical disturbance.

Assessment Questions

1) What is soil?

2) What forms of life exist in soil ecosystems?

3) How would you define a “healthy” agricultural soil?

4) What is a soil food web?

5) What might be some negative effects of the long-term practice of monoculture cropping and the use of synthetic chemical fertilizer and pest control agents on the soil ecosystem?

Assessment Questions Key

1) What is soil?

- *An ecological system consisting of inorganic minerals (sand, silt, clay, and nutrients), pore spaces, water, gases, organic matter, living organisms, and plants*

2) What forms of life exist in soil ecosystems?

- *Bacteria, fungi, actinomycetes, millipedes, isopods, mollusks, insects, insect larvae, worms and many small vertebrate animals such as gophers, ground squirrels, moles, etc.*

3) How would you define a “healthy” agricultural soil?

- *A soil with a set of desirable physical and chemical properties which has the capacity to sustain biological productivity, maintain environmental quality, and promote plant, animal, and human health. This would include many of the following general characteristics:*

- adequate rooting depth for the crop(s) to be grown*
- a 3–5% organic matter content*
- maintains stable soil aggregates*
- allows for rapid water infiltration without soil erosion*
- a low bulk density (good structure with minimal compaction)*
- pH between 6 and 7*
- an extractable nutrient profile within the optimal range of physiological tolerance for the crops to be grown*
- good water holding capacity and well-drained*
- high soil biological diversity and activity (soil respiration)*
- adequate supplies of labile organic matter with potentially mineralizable nitrogen*
- seasonal soil temperatures from 60–85°F*

4) What is a soil food web?

- *The entire assemblage of soil organisms (producers, consumers and decomposers) in a soil ecosystem interacting among and between trophic levels*

5) What might be some negative effects of the long-term practice of monoculture cropping and the use of synthetic chemical fertilizer and pest control agents on the soil ecosystem?

- *Loss of SOM, reduction in soil aggregation, reduction in nutrient- and water-holding capacity, reduction in soil biological diversity and activity, increased pest and disease incidence*

Resources

PRINT RESOURCES

Coleman, David, and Dak Crossley. 1996. *Fundamentals of Soil Ecology*. San Diego, CA: Academic Press.

The best textbook introduction to the subject that I know of. Gives an overview of the basics, and attempts to consider the applications.

Dindal, Daniel, ed. 1990. *Soil Biology Guide*. NY: Wiley.

A weighty tome, with chapters including taxonomic keys and basic biology/ecology on virtually all organisms found in soils.

Doran, John, and Alice Jones (eds.). 1996. *Methods for Assessing Soil Quality*. Special Publication # 49. Madison, WI: Soil Sci. Soc. America.

Soil quality is the current buzzword in soil science circles. This volume explores the application of the idea to sustainable environmental management.

*Gershuny, Grace, and Joseph Smillie. 1999. *The Soul of Soil: A Soil-Building Guide for Ecological Farmers and Gardeners, 4th Edition*. White River Junction, VT: Chelsea Green Publishing.

More hands-on and less academic than the above works, this book is aimed at plant growers and has lots of practical information.

Gibbons, Boyd. 1984 (September). Do we treat our soil like dirt? *National Geographic*, pp 351-388.

An overview of US soils, from soil biota to bankrupt farmers, done in classic NG style, with lots of great photos and drawings.

Gliessman, Stephen R. 1998. *Agroecology: Ecological Processes in Sustainable Agriculture*. Chelsea, MI: Ann Arbor Press.

Provides a brief overview of the most commonly used conventional agricultural practices and the environmental and agroecological consequences of their use.

Tugel, Arlene, Ann Lewandowski, and Deb HappevonArb, eds. 2000. *Soil Biology Primer, Revised Edition*. Ankeny, Iowa: Soil and Water Conservation Society.

An excellent overview of soil biology, loaded with glossy photos and colorful chart. Available from www.nrcs.usda.gov/wps/portal/nrcs/main/soils/health/biology/.

WEB-BASED RESOURCES

Appropriate Technology Transfer for Rural Areas (ATTRA)

attra.ncat.org/publication.html#soils

Colorado State University Extension, Garden Notes: The Living Soil

www.ext.colostate.edu/mg/gardennotes/212.html

Introduces various types of beneficial soil organisms and their roles, as well as how to encourage beneficial organisms by creating a favorable soil environment.

European Atlas of Soil Biodiversity

eusoiils.jrc.ec.europa.eu/library/maps/Biodiversity_Atlas/

Information-rich resource on soil organisms offers a comprehensive guide to soil biology, soil ecosystem functions, and the ecosystem services that soil organisms provide (e.g., nutrient cycling).

Food and Agriculture Organization (FAO) of the United Nations

www.fao.org/agriculture/crops/thematic-sitemap/theme/spi/soil-biodiversity/agriculture-and-soil-biodiversity/en/

Discusses the effect of different agricultural practices on soil organisms. Includes information on how to improve soil biodiversity through soil management, sustainable agriculture, and agroecological farming options.

www.fao.org/docrep/009/a0100e/a0100e0d.htm

Describes the categories and characteristics of soil organisms, including beneficial and harmful organisms in agricultural soils. Includes a

discussion of the effects of organic matter on soil properties.

Great Lakes Worm Watch!

www.nrri.umn.edu/worms/identification/ecology_groups.html

Excellent description of earthworm ecological groups

Nature Education, The Rhizosphere – Roots, Soil and Everything in Between

www.nature.com/scitable/knowledge/library/the-rhizosphere-roots-soil-and-67500617

Comprehensive description of the rhizosphere, including an excellent description and graphics of legume-rhizobia symbiosis, mycorrhizal fungi and nutrient acquisition, and root system architecture. Includes a useful glossary

USDA, Natural Resources Conservation Service

www.nrcs.usda.gov/wps/portal/nrcs/main/soils/health/biology/

www.nrcs.usda.gov/wps/portal/nrcs/main/soils/health/resource/

Resources and publications on soil health, including information sheets and technical notes on soil organic matter, soil erosion, soil biodiversity, and soil quality evaluation

http://www.nrcs.usda.gov/wps/portal/nrcs/detail-full/soils/health/biology/?cid=nrcs142p2_053868

Thorough discussion of the soil food web, written by Elaine Ingham.

SOIL QUALITY

Appropriate Technology Transfer for Rural Areas (ATTRA)

www.attra.org/attra-pub/soil-lab.html#Soil%20Health

Illinois Soil Quality Initiative (ISQI)

www.aces.uiuc.edu/~asap/resources/isqi/soil-health.html

Life in the Soil

www.crcslm.waite.adelaide.edu.au

Soil and Health Library

www.soilandhealth.org/index.html

Soil Biological Communities

www.blm.gov/nstc/soil/index.html

Soil Ecology Society

vax.wcsu.edu/ses/ses.html

Soil Quality Institute—NRCS

www.nrcs.usda.gov/wps/portal/nrcs/main/soils/health/

The Soil Foodweb: Its Importance in Ecosystem Health, Elaine Ingham

www.rain.org/~sals/ingham.html

University of California Sustainable Agriculture Research and Education Program (UC SAREP)

www.sarep.ucdavis.edu/soil/websites.htm

SOURCES OF SUPPLIES

Fisher Scientific, Pittsburgh, PA

www.fishersci.com
(800) 766-7000

Scientific Industries

2207 Blue Bell Ave. Boulder, CO 80302
(303) 443-7087

Appendix 1: Major Organic Components of Typical Decomposer Food Sources

	PROTEINS	FATS	CARBOS	SIMPLE CELLULOSE	HEMI- CELLULOSE	LIGNIN	ASH
Oak leaf (young)	9	8	22	13	16	21	6
Oak leaf (old)	3	4	15	16	18	30	5
Pine needle	2	24	7	19	16	23	2
Grass leaf	2	2	13	24	33	14	0
Corn stem	1	2	15	18	30	11	8
Wood	0	4	2	22	47	22	1
Horse manure	7	2	5	24	28	14	9
Bacteria	50–60	10–35	5–30	4–32	0	0	5–15
Fungi	14–52	1–42	8–60	2–15	0	0	5–12
Earthworm	54–72	2–17	11–17	0	0	0	9–23
Arthropods	38–50	13–26	14–31	5–9	0	0	0

Appendix 2: Litter Bag Data Sheet

burial date:

location:

retrieval date:

details:

LITTER BAG #	HABITAT	% REMAINING (VISUAL ASSESSMENT)	AVERAGE PER HABITAT	OTHER OBSERVATIONS
1				
2				
3				
4				
5				
6				
7				
8				
9				
10				
11				
12				
13				
14				
15				
16				
17				
18				
19				
20				
21				
22				
23				
24				
25				
26				
27				
28				

Appendix 3: Litter Bag Data Sheet Example

burial date:

location:

retrieval date:

details:

LITTER BAG #	HABITAT	% REMAINING (VISUAL ASSESSMENT)	AVERAGE PER HABITAT	OTHER OBSERVATIONS
1	compost	5		
2	compost	25		
3	compost	80		
4	compost	90	50.0	
5	orchard soil	100		
6	orchard soil	100		
7	orchard soil	70		
8	orchard soil	90	90.0	
9	raised garden bed	97		
10	raised garden bed	99		
11	raised garden bed	72		
12	raised garden bed	95	90.8	
13	row crop	97		
14	row crop	95		
15	row crop	94		
16	row crop	96	95.5	
17	soil surface	100		
18	soil surface	100		
19	soil surface	100		
20	soil surface	99	99.8	

Appendix 4: Soil Respiration Data Sheet

Soil Respiration (at Initial Field Water Content)							Date:	
Sample site	Ring height	Start time	End time	Soil temp °C	Draeger tube %CO ₂ (n=1)	Soil respiration lbs C/A/day*	Draeger tube %CO ₂ (n=5)	Soil respiration lbs C/A/day*
1						0.0		0.0
2						0.0		0.0
3						0.0		0.0
4						0.0		0.0
5						0.0		0.0
6						0.0		0.0
7						0.0		0.0
8						0.0		0.0

Soil Respiration (at least 6 hours after irrigation or soil wetting)		Date:
1	0.0	0.0
2	0.0	0.0
3	0.0	0.0
4	0.0	0.0
5	0.0	0.0
6	0.0	0.0
7	0.0	0.0
8	0.0	0.0

* Soil respiration = PF x ((Soil Temp C + 273)/273) x (CO₂% - 0.035) x 22.91 x Ring Ht = lbs CO₂-C/acre/day
 PF = Pressure Factor = 'raw' barometric pressure in inches Hg/29.9 inches.
 Note: This adjustment is necessary at elevations > 3,000 ft.; otherwise PF = 1
 H = 5.08 cm (if not measured)
 Conversion: Degrees Celsius = 5/9 x (Degrees Fahrenheit - 32)
 Notes:

Appendix 5: Earthworm Data Sheet

DATE:

SAMPLE SITE	EPIGEIC EARTHWORMS	ENDOGEIC EARTHWORMS	ANECIC EARTHWORMS	TOTAL EARTHWORMS	EARTHWORMS PER SQ METER
1					
2					
3					
4					
5					
6					
7					
8					
9					
10					
11					
12					

NOTES:

- Epigeic: Small; dark red or brown color; fast growing; move quickly
- Endogeic: Small to medium; light or no pigmentation; slower moving
- Anecic: Large and very muscular; wedge-shaped tail; color on front end, less on tail end; slow growing

Appendix 6: Arthropod Data Sheet

	1	2	3	4	5	6	7	8	9	10	11
sample site:											
isopods											
springtails											
spiders											
mites											
earwigs											
aphids											
beetles											
fly larvae											
fly adults											
ants											
wasps											
crickets											
millipedes											
centipedes											
slugs & snails											

Social and Environmental Issues in Agriculture

Introduction to Part 3: Social and Environmental Issues in Agriculture	2
Unit 3.1: The Development of U.S. Agriculture and the Food System	3
Unit 3.2: Social Issues in Current U.S. Agriculture	31
Unit 3.3: Environmental Issues in Modern Agriculture	53
Unit 3.4: Sustainable Agriculture and Sustainable Food Systems	73

INTRODUCTION TO PART 3

Social & Environmental Issues in Agriculture

People become interested in organic farming and gardening for a variety of reasons: to grow food in a more “natural” manner; to improve food security in urban neighborhoods; to open up new markets; to work with youth in organic school gardens; to take action to create a more sustainable future. As part of that interest, many seek to be active players in creating a food system that is more environmentally sound, economically viable, and socially responsible, and that will serve as a foundation for future generations.

Creating a more sustainable food system requires understanding the existing food system. What is it? How did it become what it is? What are the consequences of its current structure? What has already been done to change it? These are the questions that are addressed in the following four units.

Unit 3.1 includes three lectures. The first two explore the history and development of the U.S. food system. They outline the rapid rise from subsistence farming to agricultural globalization, and detail the primary factors that have influenced the food system’s current shape. The third lecture defines a food system, and provides a snapshot of its many features as they exist today.

Unit 3.2 chronicles the social impacts and workings of the current system. Three major themes are explored in two lectures—labor, concentration, and health.

Unit 3.3 examines the most common practices used in conventional agricultural production, and the major agricultural, environmental, and human health concerns that have emerged as a result of their use over the past century.

Unit 3.4 outlines the various resistance movements that have arisen to oppose the conventional U.S. agricultural system. These struggles and resistance movements started, along with larger changes in the agricultural system, in the mid 1800s. The first two lectures examine the resistance to the agricultural system, and the third lecture more specifically outlines social justice-related activities.

Along with the specific learning objectives for each section, it is hoped that through these lectures students will come to understand that the current U.S. agriculture and food system did not just “spring up.” Human decisions and actions, along with environmental contexts, led to the system we see today. Understanding why we are where we are, and what has gone before us to make change, is a first and critical step to understanding how to contribute fully to the larger effort of creating a more sustainable food system.

The Development of U.S. Agriculture

Introduction	5
Lecture 1: History and Large-Scale Changes in Agriculture and the Food System	7
Lecture 2: Capital, Politics, and Overproduction in Agriculture and the Food System	11
Discussion Questions, Lectures 1 and 2	15
Lecture 3: The Current U.S. Food and Agriculture System	16
Discussion Questions, Lecture 3	22
References and Resources	23
Appendix 1: Food System Graphics	
Graphic #1: Food System	28
Graphic #2: The Food System Model	29
Graphic #3: Nourish Food System Map	30

Introduction: The Development of U.S. Agriculture

UNIT OVERVIEW

To better understand the current food and agriculture system, we need to see where it comes from and how it developed. This unit provides students with this historical context for current issues in the U.S. agriculture and food (agrofood) system. It chronicles the comparatively rapid rise from subsistence farming to agricultural globalization. It shows the many factors that influenced the shape of the system today—including political, economic, social, ecological, and technological factors, innovations, and failures.

The first lecture begins with an outline of general trends in the development of the United States agrofood system. The ways in which historical land use practices, settlement policies, and labor management practices have influenced agricultural development in the U.S. are then covered, followed by an outline of the increasing emphasis on science and technology-intensive inputs that characterizes much of U.S. agriculture. This includes an overview of the federal policies responsible for the development of the U.S. agricultural research complex. This complex has generated the innovations in agricultural technologies that have shaped both the production and processing of food and fiber in America.

The second lecture begins with a discussion of the ways in which large-scale capital investment, enabled by advances in agricultural science and technology, has entered U.S. agriculture, and the structural changes that have resulted. Corn is examined as a case study of how science, capital, and policy interact in the context of agricultural development. The lecture next outlines the effects of the confluence of policy, technology, and capital on agricultural development. These effects are overproduction and surplus, the cheap food policy, and the technology treadmill. Finally, the lecture explores how these themes play out globally, to understand the larger context within which the U.S. food system operates.

The third lecture focuses on the current U.S. food system. It starts by defining what a food system is, then provides a snapshot of what is happening in its various components.

MODES OF INSTRUCTION

> (3 LECTURES, 50 MINUTES EACH)

Lectures 1 and 2 cover the historical development of the U.S. food and agriculture system, focusing on the circumstances that have been largely responsible for its current structure. Lecture 3 focuses on the current food system. References given in the lecture outlines are described in the References and Resources section.

LEARNING OBJECTIVES

CONCEPTS

- The history of U.S. agricultural development, from before the Common Era (pre-A. D.) to the early 1700s
- The changes in control over the means of production (land, capital, and other resources) in the U.S. food system from approximately 1900–2000
- The way that historical land use practices, land settlement policies, and labor management strategies have influenced U.S. agricultural development
- U.S. federal policies that have been responsible for the development of the U.S. agriculture research complex and the innovations in technologies that have shaped the direction of U.S. agriculture
- The influence of investment capital on the adoption of agricultural technologies and the concentration of ownership in food and agriculture
- The food system is composed of a supply chain—production, processing, distribution and consumption—but it both impacts, and is impacted by a broader economic, political, social and environmental context

Lecture 1: History & Large-Scale Changes in Agriculture & the Food System

A. Early U.S. Agriculture

- 1) Pre 1600s
 - a) Native Americans, in the North American region of the continent, were possibly farming as early as 5000 B.C.
 - b) By A.D. 800, corn or maize was considered one of the most important crops
 - c) By A.D. 1000, many Native Americans were cultivating corn, beans, and squash – a staple that is considered to provide a steady food supply for villages
 - d) Tobacco was another common crop. Foraging and hunting were also food generation strategies.
 - e) Land tenure was generally held by the village claiming sovereignty over an area. Some tribes allowed individual control of fields within these regions. In some villages, this control was passed down to family members, generally from mother to daughter.
- 2) 1600s
 - a) Most early colonists were not farmers, and not here to farm. Many were religious dissenters, adventurers, or those seeking fortune. Even those that did intend to farm found conditions different than what they were used to. However, community survival depended on learning to farm.
 - b) Agricultural practices were mostly learned from Native Americans – particularly growing corn for food and tobacco to trade. Other common crops grown include beans and squash as staples. Wheat was common in the middle colonies, and cattle in the north.
 - c) Technology consisted primarily of few tools, such as the ax and hoe. Plows were often scarce or homemade.
 - d) These hand-intensive crops relied on lots of labor, which was primarily from large families in the North (where religious groups came as families), and indentured servants and slavery in the South. Indentured servitude made up the primary labor for the tobacco growing regions of Maryland and Virginia during this time.
- 3) Early 1700s
 - a) Meat production became more in demand, and corn was used to feed both people and animals
 - b) Regions became specialized in what they produced. Other grains became important for feeding cities (wheat in particular). Tobacco, rice, and indigo became primary crops in the South.
 - c) Labor trends changed, with slavery becoming more established and indentured servitude decreasing
 - d) Technology still consisted primarily of hand tools. A sickle or cradle scythe was used to harvest grains—which one skilled person could use to harvest 3 acres in a day.

B. Large-Scale Changes

1. Land use and settlement (see Cochrane 1993, chapters 4 and 5; Hurt 1994; Walker 2004)
 - a) Agriculture was the dominant land use and economic activity of the early United States
 - i. >90% of U.S. populace was involved in agriculture pre-1900
 - b) Early U.S. government considered land its most abundant resource
 - i. Native Americans' rights to land were not acknowledged and lands were taken from them

- c) During the revolutionary war and shortly after, colonists view of land tenure changed
 - i. They considered land as no longer just being held by the king of Great Britain, a small group of English noblemen, and a handful of men granted large tracts of land by the English nobility. The colonists decided that states and the federal government were to have control of how to distribute the land.
 - d) Encouraged extensive agricultural development
 - i. Since land was considered to be a nearly limitless resource, farmers had few incentives for soil conservation or long-term soil fertility management
 - ii. Effect: Exploit native fertility until depleted, then move on to more fertile soils
 - e) Early federal land settlement and development policies had several effects
 - i. The landscape to the west of the Appalachian mountains was quickly populated with people from the East engaged in agriculture
 - ii. Native Americans were displaced by military force, treaties, and federal policy, establishing the reservations on fractions of the land they once occupied
 - f) Key early federal land settlement and development policies
 - i. Several early policies for land distribution favored the conservative trends, mostly enabling only speculators with abundant resources to buy land and re-sell tracts at higher prices (Ordinances of 1784 and 1785; Act of 1796; Act of 1800, etc.)
 - ii. The Homestead Act of 1862 allowed for any “head of a family or [21-year old]... citizen of the United States” (or who had the intention of becoming a citizen) to gain access and eventual ownership (within five years’ time) of up to 160 acres of “unappropriated public lands” for a low fee, providing that the individual resided upon the land
 - The Homestead Acts drove the transformation of land into agricultural uses, and, in combination with the development of the transcontinental railroad system, extended reach of the United States westward
 - Though the Homestead Act did not technically exclude African-Americans, Native Americans, or women from taking advantage of this opportunity, given the social and political realities of the time, White males were the primary targets for the program
 - A number of related acts and amendments followed the Homestead Act of 1862, each allowing the possibility for land grants to individuals, and driving U.S. agricultural development. These included The Southern Homestead Act of 1866, the Timber Culture Act (1873), and others during the early part of the 20th century.
 - iii. Railroad land grants established infrastructure for distribution of food, fiber
 - iv. Reclamation Act (1902): Irrigation projects opened up vast tracts of the Southwest and California for agriculture
 - v. Exceptions: California, Southern U.S.—characterized by large landholdings and thus a form of large-scale capitalist agriculture (vs. individual small-holdings in other parts of the country) from the very beginning (Walker 2004)
2. Agricultural labor (see L. Jelnick 1979; M. Wells 1996; McWilliams 2000; Walker 2004 ; Hurt 1994)
- a) Slavery (1619–1865): Enabled exception to small-scale, family-scale farming that characterized much of early U.S. agriculture. Slavery allowed for large increases in the scale of production.
 - b) Post-slavery, sharecropping was common in the South. In this system, tenant farmers were allowed to use the land, and received a percent of profits from the crop they grew. Sharecropping generally kept farmers in debt and poverty. Immigrants were brought in to fill the need as African-Americans started working in other industries (National Farm Worker Ministry, n.d.).

- c) Immigrants were increasingly recruited to work in agriculture as wage laborers. Policy changes led to a succession of ethnic groups being recruited:
 - i. Chinese immigrants were brought in as laborers until the Chinese Exclusion Act of 1882 prohibited immigration
 - ii. Filipinos were brought in as farm laborers until they began to organize in the early 1930s
 - iii. Japanese laborers were brought in as farmworkers and worked in that role until Japanese were sent to internment camps during WWII
 - iv. Mexican laborers were recruited at several distinct points, including WWI; during the Bracero Program (1942–1964), a series of agreements between the Mexican and U.S. governments allowed temporary importation of Mexican workers into the U.S. Mexican laborers were deported or encouraged to leave when white U.S. farmers bankrupted by the dust bowl of the 1930s migrated west and became farmworkers (National Farm Worker Ministry, n.d.).
 - v. Waves of immigration resulted in a continuous supply of low-wage workers with little status or political power to influence working conditions (L. Jelnick 1979; M. Wells 1996 ; McWilliams 2000; Walker 2004). (see Unit 3.2, Social Issues in Current U.S Agriculture, Lecture 1 for more information on impact to workers.)
- 3. The development of scientific agriculture (see Cochrane 1993, chapter 7; Hurt 1994, chapter 7; Hightower 1973, chapters 1–2; Gardner 2006, chapter 2)
 - a) Pre-1860s
 - i. Agricultural innovation and knowledge exchange were hands-on and farmer-to-farmer
 - ii. Agricultural knowledge and innovation were created on-farm
 - iii. Basic agricultural techniques and yields per acre had reached a plateau
 - iv. Most agricultural labor was done by hand
 - b) Federal policies established the scientific agricultural enterprise, which moved knowledge production from the farm and farmers to the university and scientists
 - i. U.S. Department of Agriculture was established in 1860 and devoted to improvement of agriculture based on scientific inquiry
 - ii. Land Grant Colleges of Agriculture were established to conduct research and development—Morrill Act (1862, amended 1890)
 - iii. Agricultural experiment stations were established to work on practical agricultural problems—Hatch Act (1887)
 - iv. Cooperative Extension service was established to diffuse innovations to farmers—Smith-Lever Act (1914)
 - v. The Secretary of the Interior was authorized to develop irrigation and hydropower projects in 17 arid Western States—Reclamation Act (1902)
 - vi. Agricultural economics were included within the research agenda of land grant universities—Adams Act (1920s)
 - c) Some key technological developments derived from the scientific agricultural enterprise that spurred significant increases in total and per capita productivity
 - i. Mechanization—in particular the tractor—spurred large early increases in productivity
 - New improvements in the 1930s led to the tractor’s escalating adoption. By the 1950s, the use of the draft horse and mule were negligible.
 - Tractors allowed for more acreage to be cultivated. During WWII, tractors made it possible to add 9 million acres of corn and 2 million acres of wheat to U.S. farming production.

- ii. Hybridization—both plants and animals
 - The first hybrid corn was commercially produced in the 1920s. It allowed the yield per acre of corn to double or triple and was adopted widely by the 1940s.
- iii. Chemical pesticides (insecticides, herbicides, and fungicides) and synthetic nitrogen and phosphorus fertilizers were being developed during the early 1900s and adopted throughout the early and middle century
 - Commercial fertilizer use grew steadily starting in 1900, with a big jump in the use of synthetic nitrogen in the 1950s and 1960s (Gardner 2006, p. 22–24)
 - Chemical pesticides became widely used after WWII; many were a product of weapons development (Gardner 2006, p. 24–25)
- iv. Reclamation and irrigation of the arid West increased productive capacity enormously
 - This effort started in 1902 with the Reclamation Act. Reservoirs, irrigation, and other projects were further subsidized during the Depression era, and continued both during and after WWII (Cochrane, p. 225–7).
- v. Continued pressure for extension of seasons to allow for year-round availability of commodities
- vi. The effects of widespread adoption of the above technological innovations in agriculture included:
 - Significant increase in the production and use of mechanization, synthetic pesticides, and synthetic fertilizers
 - Vast reduction in labor requirements on farms, which facilitated major rural-urban migrations and provided more workers for factories
 - Significant and rapid increase in farm size and decrease in the number of farmers that could remain in business
 - Huge expansion of scale of agricultural production
 - Specialization and monoculture production were encouraged; separated crop from livestock production, resulting in the biological simplification of agroecosystems
 - Input production (e.g., seed saving) and processing moved off-farm

Lecture 2: Capital, Politics, & Overproduction in Agriculture & the Food System

A. The Development of Corporate Influence in Agriculture

(see Goodman et al. 1987; Goodman 1991; Kloppenburg 2004; Heffernan 1998)

The impact of capitalism was another major influence shaping the development of the current agriculture and food system

1. There were several historical barriers to the industrialization of U.S. agriculture (see Mann and Dickinson 1978; FitzSimmons 1990, pp. 13–14; Lyson 2004, p. 16)
 - a) The primary barrier is the presence of “nature” in agriculture: The vagaries of seasons and the inability to control environmental conditions. Agriculture does not work the way factories do, where all the conditions can be structured and controlled. This lack of control leads to more risk in investment for businesses.
2. Although production itself had barriers, private capital (businesses) found other roles to play in the food system (see Heffernan 1998; Goodman 1991)
 - a) As technologies of all sorts developed, investment capital moved in to manufacture and distribute them. This includes seeds, fertilizers, tractors, etc.
 - b) Distribution and processing of farm products is the other area where private investment and capital flowed into the food system (Heffernan 1998)
 - i. Railroads were an early private distribution system farmers were dependent upon in the expanding U.S. As farmers moved West, their consumers were still in the East. Farmers depended on railroads to transport their crops.
 - ii. Animal slaughtering and processing, as well as grain storage and processing, were other areas for capital investment
3. The creation of the “Cost-Price Squeeze”
 - a) Competitive advantage is gained by farmers who adopt capital-intensive technologies—and then make more money based on the economy of scale
 - i. For example, those that invested in tractors, hybrid seeds, or fertilizers could get higher yields and make more money
 - b) These technologies increase farmers’ dependence on inputs they must purchase from companies. As the prices of those inputs increase, so do the costs of production for the farmer.
 - c) Increasing private and corporate ownership of the agricultural inputs, food processing, and retail sales sector of the economy begins to appropriate increasing proportion of food dollar, and thus power over the food system
 - d) Farmers are “sandwiched between a monopoly-controlled agriculture input sector and a monopoly-controlled output (processing and retail) sector” (Lobao 1990, p. 27)
 - e) Farmers become “price-takers”—they must take market price set by the small number of corporation buyers, resulting in decreased prices paid and thus dwindling share of the food dollar to farmer
 - f) Farmers gradually lose power, autonomy, economic self-determination
 - i. The loss of economic self-determination shows in recent statistics: Small to mid-sized farms, defined as those grossing between \$100,000 and \$250,000, only had average net earnings of \$19,274 in 2009, and that figure includes subsidy payments (Wise 2011)

4. As sector matures, concentration of input suppliers/processors/retailers into monopolies and oligopolies expands. This dynamic of concentration has been picking up in the last half of the 20th century, but particularly in more recent decades (see Heffernan 1998).
 - a) Industrial consolidation
 - i. Post-harvest transportation and storage: Cargill, Cenex Harvest States, ADM, and General Mills were responsible for 60% of the grain handling facilities as of 2002 (Hendrickson and Heffernan 2002)
 - ii. Processing and value-adding: ADM, Bunge & Cargill, and Ag Processing did 85% of the crushing of soybeans; Cargill CHS, ADM, and ConAgra did 52% of the grain milling as of 2006 (James, Hendrickson & Howard, 2012)
 - iii. Retail: Walmart, Kroger, Safeway, and Supervalu commanded between 42–51% of the market in 2010 (James, Hendrickson and Howard, 2012)
 - iv. Other food industry consolidation in pictorial form: Seeds, organic industry, soft drinks, etc.: See www.msu.edu/~howardp/infographics.html
 - b) Example of consolidation for growers: Chickens (see Unit 3.2, Lecture 2, for examples)

B. Modern Corn: A Case Study in Research, Capital, and Politics in Agriculture

(see Berlan and Lewontin 1986; Kloppenburg 2004; Pollan 2006, section I)

1. The corn seed as an example of the above processes operating in agriculture
 - a) In seed form, corn is both a productive commodity (i.e., grain) and has reproductive capacities (seed)
 - b) Seed is a strategic point of control for capitalist penetration of agriculture: The control of seed = control of the self-sufficiency (or market dependency) of farmers and farming
 - c) The story of modern corn is a story of a struggle for that control; and the use of agricultural research and science as a tool of private capital, facilitated by publicly funded research and policy
2. Pre-1920s: Farmers saved a portion of crop as seed to plant the next year
 - a) Maintained a degree of autonomy from purchased inputs
 - b) High degree of genetic diversity and regional variation
3. Hybridization
 - a) Developed in 1920s by Pioneer Hi-Bred, with help from USDA and U.S. patent protection laws
 - b) Doubled and tripled yields resulted from hybrid seed strains
 - c) Facilitated mechanization of production: Uniform height and maturation time
 - d) Consequence: Would not “reproduce true to type”—forced farmers to buy seed every year
 - e) Almost universally adopted by early 1930s
4. Other factors
 - a) Inexpensive and synthetic fertilizers, along with hybrid seeds, made greatly increased yields possible. Corn needs large amount of nitrogen, and thus farmers were even more dependent on inputs purchased from outside the farm.
5. Contemporary developments in agricultural technology: Genetic engineering
 - a) Further application of agricultural science in the service of private capital
 - b) Created and sold as “technology packages” (e.g., Roundup Ready™ seed and Roundup™)
 - c) Novel methods of intellectual property protection (see Supplement 1, Genetic Engineering in Unit 1.4, Transplanting and Direct Seeding, for more information)

- i. Technology use agreements: Power of seed companies puts growers in a disadvantaged relationship (see Unit 3.2, lecture 2 and Supplement 1 in Unit 1.4). They have to pay much more for these seeds and have limited control of their use (cannot legally replant them, but must buy new seeds each year).

C. Impacts of History of Development: Chronic Surplus, Overproduction, Export Agriculture, and Global Food Trade

(see Holt-Giménez and Patel 2009, Chapter 4; Cochrane 1993, Chapter 8; Friedmann 1993; Lobao 1990, Chapter 1; Danbom 1995, Chapter 11)

1. Surplus and overproduction
 - a) Fueled by development of agricultural technology and labor-saving devices
 - b) Exacerbated by federal farm subsidies, commodity payments, price supports to largest producers
 - c) Keep crop prices paid to farmers chronically low
 - d) Those farmers not receiving subsidies are placed at an economic disadvantage
 - e) Farmers' status as price-takers and the cost-price squeeze give them little margin for error
 - f) Overproduction has been constant since 1880s (with exception of wartime periods)
 - g) Slim profit margins discourage farmers from adopting conservation farming practices that do not show economic return or that require reinvestment of capital
2. The "cheap food policy": Examples of effects
 - a) Food processing and grain trade industries such as Cargill and ADM are the primary beneficiaries of inexpensive grains. Low grain prices are also good for the grain-fed U.S. meat industry.
 - b) Chronic overproduction keeps some food prices low (for consumers)
 - c) Hurts farmers seeking economic viability
 - d) Important for feeding the population of industrial workers who earn low wages
3. Export agriculture
 - a) Surpluses exported, formed the basis for global food trade
 - i. Major source of revenue and catalyst for U.S. overseas economic development
 - ii. Overseas commodity markets of major strategic importance to U.S.
 - iii. Key component of bi-lateral and multi-lateral Free Trade Associations (FTAs) and the World Trade Organization (WTO)
4. The "production treadmill"
 - a) Increases in overall U.S. production typically result in decreased prices. Farmers have little control over this aggregate production, and must continually increase their own yields just to obtain the same revenue.
 - b) Encourages farming in monocultures and on marginal lands; discourages conservation
 - c) Creates a climate in which early adopters of capital-intensive, yield-increasing technologies are rewarded (e.g., GMO corn, soy), or penalized less
 - d) Those who do not adopt technologies are driven out; leads to familiar pattern of bankruptcy and consolidation

D. Global Food System and Its Relationship With the U.S.

(see Holt-Giménez and Patel 2009, Chapter 3)

Many of the trends happening in the U.S. were implemented worldwide

1. Science and capital together: The green revolution (1960–1990)
 - a) The green revolution aimed to keep countries fed and willing to resist communism. It was a huge effort by a few foundations and Western governments to create hybrid seeds that would be well adapted to local conditions. These seeds "...were dependent on 'packages' of credit, fertilizers, and timely irrigation" (Holt-Giménez and Patel 2009, p. 27). The results of this technology-intensive system were similar to those that occurred in the U.S., in that they system benefited the larger farms, and mostly disenfranchised smaller farms.
 - b) It did not work for poor and women
 - c) It led to more concentration of land ownership
 - d) Farmers forced off the land became part of the urban cheap labor force
 - e) The green revolution "... also produced as many hungry people as it saved." (Holt-Giménez and Patel 2009, p. 24)
2. Structural adjustment programs (SAPs), which started in the 1980s, were instituted by the International Monetary Fund (IMF) and the World Bank when they made loans. Under the premise that "free trade" will lift all boats and work best to help countries "develop," supports to agriculture were cut. This includes price supports, research infrastructure, and trade tariffs to protect the internal agricultural product prices in the South. These SAPs created situations that benefited the corporations dominating agriculture.
3. Free trade agreements (FTAs) and the World Trade Organization (WTO) codified the structural adjustments, and instituted other policies that benefited Northern corporations at the expense of Southern countries
4. Overproduced food in the U.S. and Europe sent as "food aid" overseas often undercut prices of production for local farmers. Similarly, through FTAs and WTO agreements, the U.S. and Europe have continued subsidizing their agriculture, while the Southern countries are not allowed to do this, continuing the undercutting of Southern farmers.
5. Thus, many countries are not able to protect their food system or sovereignty. "... by 2005, 72% of all countries in the global South had become net food importers" (Holt-Giménez and Patel 2009, p 44).
6. Together, these systems create consolidation, drive smaller shareholder farmers from the land, encourage immigration for work, and decrease sovereignty

Discussion Questions, Lecture 1 & 2

DEVELOPMENT OF U.S. AGRICULTURE, LECTURES 1 & 2

- 1) Why do you think it is important to understand or study the development of the food system?
- 2) What did you learn from these 2 lectures that was surprising to you? Why was it surprising?
- 3) What are some of the most concerning aspects of the current, dominate U.S. food system?
- 4) Who do you think most benefits from the current system? How?
- 5) Are there any parts of this history that you are interested in learning more about? Why?
- 6) How does learning about this history impact what you plan to do with the food system in the future (as a farmer, activist, consumer, etc.)?

Lecture 3: The Current U.S. Food & Agriculture System

The U.S. food system as it exists today is the culmination of conditions, events, and actions taken over time. Some of the conditions and actions were described in Lectures 1 and 2. This lecture explores what defines and comprises a food system, and looks at the food system in the U.S. today. Footnotes are used in this lecture due to the large number of references and links, to enable easier access to the source documents.

A. What is a Food System?

(see Goodman et al. 1987; Goodman 1991; Kloppenburg 2004; Heffernan 1998)

The impact of capitalism was another major influence shaping the development of the current agriculture and food system

1. Definitions

- a) A food system encompasses everything involved in feeding people. This includes the production, processing, distribution, consumption, and disposal of food. It also includes inputs (such as soil, water, energy, knowledge, capital, machinery) that go into the various steps of the process. The food system operates within a larger context—which it influences and by which it is influenced. This includes biological, economic, political, and social systems.
- b) “The modern food system has really come together since the Second World War. As The Oxford English Dictionary defines a system, it is a ‘set or assemblage of things connected, associated or interdependent so as to form a complex unity, a whole.’ The food system reflects the prevailing social and economic influences around the world and is a system largely developed, run, and promoted world-wide by economic institutions in the rich and powerful industrial nations.” (Tansey and Worsley, 1995, p. 2)
- c) “. . .the modern world of food is not a random series of ‘facts’ and ‘events’, but a complex and ever-changing web of industrial, technological, economic, social and political factors that shape the journey food takes from its production on the farm to the eventual consumers.” Millstone and Lang 2008, p. 9
- d) Some people talk about the entire food system. Others talk about the multiple systems, such as the local food system, or a community food system. There is no universal or accepted definition of a food system.

2. Aspects of the food system

- a) Appendix 1, Food System Graphics, shows three figures depicting the food system. Figure #2 is the simplest version, and Figure #3 gives the most detail. Additional graphical depictions can be found on-line, and several of these are referenced under Web-based Resources at the end of this unit.
- b) These depictions frequently start with a food chain—generally beginning at the point of food production—then proceeding through processing, distribution, consumption, and then to the waste stream. They also include the context or system that influences, and is influenced by, the food chain. These include social, economic, and environmental factors.

B. Characteristics of the Current U.S. Food System Supply Chain

1. Production

- a) Who is producing the food?
 - i. As in the rest of the food chain, there is significant concentration in production. In 2012 in the U.S., 4% of farms produced 66% of the food (based on value/price of the food).¹
 - ii. In 2012, principal farm operators were primarily white males (83%).² However, there has been growth in the number of minority-operated farms between 2007 and 2012.³ The percentage of women farmers stayed close to the same between the 2007 and 2012 (from 13.9% to 13.7%).⁴
 - iii. The average age of farmers increased from 55.3 in 2002 to 58.3 in 2012.⁵
 - iv. In 2007, there were 2,636,509 hired farm workers on 482,186 farms in the U.S. About a third of these workers spent more than 150 days working on the farm.⁶
- b) What do we produce?
 - i. In 2007, grains and oilseeds made up 79.5% of crop production (in harvested cropland, in acres) and 62.7% of all food production (including animal production). Vegetables and melons comprised 2.5% of crop production (in harvested cropland) and 1.9% of all food production.⁷
 - ii. Corn is the primary crop—making up 44.6% of all the oilseed and grain farming, in harvested cropland. Wheat farming comprised 14.9% of the harvestable cropland for oilseeds and grain.⁸
 - iii. In 2013, the majority of soybean, corn, and cotton crops planted in the U.S. were from genetically modified seeds (to resist pests, intensive herbicide use, or both).⁹
 - iv. Animal production comprised around 50% of total market value for food production in 2007. Cattle ranching and farming made up 59.6% of the animal production, in market value sold, hog and pig made up 11.7% of the market value, and chicken and egg production made up 24.3% of the value.¹⁰
 - v. “Although large concentrated animal feeding operations (CAFOs) make up only 5 percent of all animal feeding operations (AFOs), they contain 50 percent of all animals and produce 65 percent of livestock manure.”¹¹

1 USDA. 2014. Farm Economics: Record high agriculture sales; income and expenses both up. 2012 Census of Agriculture Highlights. www.agcensus.usda.gov/Publications/2012/Online_Resources/Highlights/Highlights_Farm_Economics.pdf

2 USDA. 2014a. Preliminary report: U.S. and state data. 2012 Census of Agriculture. www.agcensus.usda.gov/Publications/2012/Preliminary_Report/Full_Report.pdf

3 USDA. 2014b. Preliminary report highlights: U.S. farms and farmers. 2012 Census of Agriculture. www.agcensus.usda.gov/Publications/2012/Preliminary_Report/Highlights.pdf

4 USDA. 2012. 2012 Census Volume 1, Chapter 1: U.S. National Level Data. Table 56. Women Principal Operators – Selected Farm Characteristics: 2012 and 2007. www.agcensus.usda.gov/Publications/2012/Full_Report/Volume_1,_Chapter_1_US/st99_1_056_056.pdf

5 USDA. 2014b.

6 USDA. No Date. Farm Labor. 2007 Census of Agriculture. www.agcensus.usda.gov/Publications/2007/Online_Highlights/Fact_Sheets/Economics/farm_labor.pdf

7 USDA. 2007. Selected characteristics of farms by North American industry classification system: 2007. Table 46. 2007 Census of Agriculture – United States Data. www.agcensus.usda.gov/Publications/2007/Full_Report/Volume_1,_Chapter_1_US/st99_1_046_046.pdf

8 USDA 2007, *ibid.*.

9 USDA. 2013. Adoption of genetically engineered crops in the U.S. Economic Research Service. www.ers.usda.gov/data-products/adoption-of-genetically-engineered-crops-in-the-us/recent-trends-in-ge-adoption.aspx#UiD7FLzkBQ8

10 USDA 2007, *op. cit.*

11 Gurian-Sherman, Doug. 2008. CAFOs Uncovered: The untold costs of confined animal feeding operations. Cambridge, MA: Union of Concerned Scientists. www.ucsusa.org/assets/documents/food_and_agriculture/cafos-uncovered.pdf, p. 9

2. Processing

- a) According to a USDA Economic Research Report, 8 of the 9 processing industries studied lost 1/3 of their processing plants and let go of 20% of their employees (between 1972 and 1992). These industries include animal processing and packing, corn and flour milling, animal feed production, soybean processing, cheese production, and milk processing.¹²
 - i. See Lecture 2, Concentration and Health, in Unit 3.2, for more examples of current consolidation, and James, Hendrickson, and Howard 2012
 - ii. ADM and Cargill are frequently in the “top 4” in processing, across different industries. Cargill is in the top 4 of beef and turkey slaughtering, beef production (feedlots), animal feed, corn milling, and soybean processing. ADM is in the top 4 of animal feed, as well as corn, flour and soybean processing.
- b) Between 1997 and 2007 the organics industry grew rapidly; during that period, ownership of organic processing companies consolidated.¹³ See the chart of consolidation at: <https://www.msu.edu/~howardp./organicindustry.html>

3. Distribution

- a) The U.S. exports a large proportion of its food—over \$11 billion in value for 2012. However, the U.S. also imports a large amount of food, over \$8 billion worth in the same year.¹⁴
- b) The U.S.’s largest imports in 2012 were cereals and bakery items, followed by fruits. Vegetables were the next largest import, in terms of metric tons. Live animals were the fourth most imported item.¹⁵ In terms of food product value, the most money was spent on fish, shellfish, and fruits.¹⁶

4. Consumption

- a) In a 2013 Gallup poll 47% of respondents said they eat at a fast food restaurant at least once a week¹⁷
- b) According to purchase studies conducted in between 1998–2006, Americans’ food purchases don’t match federal nutrition guidelines. Across incomes, regions, and ethnicities, people were more likely to not eat enough vegetables, whole fruits, legumes, or whole grains. On average, sugar intake was much higher than recommended, as was the consumption of refined grains and frozen and refrigerated entrees.¹⁸
- c) Americans have been found to eat 31% more packaged than fresh food. Additionally, they purchase much more packaged foods than people in other countries.¹⁹

12 Ollinger, Michael, Sang V. Nguyen, Donald Blayney, Bill Chambers, & Ken Nelson. 2005. Structural change in the meat, poultry, dairy, and grain processing industries. USDA, Economic Research Service. Economic Research Report 3. www.ers.usda.gov/media/850597/err3.pdf

13 Howard, Philip H. 2009. Consolidation in the North American Organic Food Processing Sector, 1997 to 2007. *International Journal of Sociology of Agriculture and Food*, vol (16), No (1). Pp. 13-30. www.ijsof.org/archive/16/1/howard.pdf

14 Calculated from “Total value of U.S. agricultural trade and trade balance.” Updated 8/6/13. www.ers.usda.gov/data-products/foreign-agricultural-trade-of-the-united-states-%28fatus%29/latest-us-agricultural-trade-data.aspx#.UijbKrzkBQ8

15 USDA, Economic Research Service. Summary data on food import values for 14 food categories, annual data since 1999. Updated 3/27/14. www.ers.usda.gov/data-products/us-food-imports.aspx#25418

16 USDA, Economic Research Service. Summary data on food import volumes for 14 food categories, annual data since 1999. Updated 3/27/14. www.ers.usda.gov/data-products/us-food-imports.aspx#25418

17 Dugan, Andrew. 2013. Fast food still major part of U.S. diet. Gallup Well-Being. www.gallup.com/poll/163868/fast-food-major-part-diet.aspx

18 Guthrie, Joanne, Biing-Hwan Lin, Abigail Okrent & Richard Volpe. 2013. Americans’ food choices at home and away: How do they compare with recommendations? USDA Economic Research Service. www.ers.usda.gov/amber-waves/2013-february/americans-food-choices-at-home-and-away.aspx#.Uijwf7zkBQ8

19 Fairfield, Hannah. 2010. Factory Food. *New York Times*, Business Section. April 3. 2010. www.nytimes.com/2010/04/04/business/04metrics.html?_r=0

5. Waste

- a) Food is one of the primary materials filling landfills and incinerators. In 2011, 36 million tons of food waste were created, with only 4% of that volume being diverted for composting.²⁰
- b) Forty percent of all food in the U.S. is thrown away²¹
- c) The economic value of wasted food in the U.S. is an estimated \$165 billion each year²²

C. The Supply Chain's Interactions With Larger Systems (see Appendix 1, Food System Graphics)

1. Economic

- a) Loans are critical to farmers, who need to have money up front to buy seeds and other inputs, and in most cases can't earn money from their crop until it is harvested and sold
 - i. Access to capital (money, loans, etc.) is the biggest barrier to entry for new farmers²³
- b) Land rents/costs—access to land is the second biggest barrier for new farmers trying to enter the profession²⁴
- c) Federal Agricultural Subsidies
 - i. The Environmental Working Group 2013 Farm Subsidy Database report on crop insurance states that "... the largest 1 percent of policy holders annually receives about \$227,000 while the bottom 80 percent receives about \$5,000."²⁵
 - ii. Approximately 10% of California's farmers receive direct subsidies. Most of the subsidies go to growers of five crops: cotton, rice, wheat, livestock, corn (but primarily the subsidies go to rice and cotton). Fruit, nut, and vegetable producers (California's specialty crop growers) make up 50% of the state's \$36 billion agricultural economy, and receive close to zero direct support.²⁶

2. Social/Cultural

- a) Access issues: Not everyone has equal access to food—see food deserts discussion in Unit 3.2, Lecture 2
- b) Inequality
 - i. People of color are more likely to live in food deserts, have less access to healthy foods, work in the most difficult and poorly paying food industry jobs, and be affected by environmental hazards due to working in or living near agriculture (see Unit 3.2, Lecture 1)
 - ii. U.S. courts found the USDA responsible for denying African Americans and Native Americans access to agricultural loans, or access to other agency programs (see *Teaching Direct Marketing and Small Farm Viability: Resources for Instructors*, Unit 1)
- c) Research: Academic research is more frequently being supported by the private sector, which provided 25% of funding for land grant agricultural research in 2010. There are concerns that this funding encourages researchers to pursue work that meets private rather than public goals. Examples—universities and percent of research budget from private entities:²⁷

20 US EPA. 2014. Reducing food waste for businesses. Updated on 3/10/2014. www.epa.gov/foodrecovery/

21 Gunders, Dana. 2012. Wasted: How America is losing up to 40 percent of its food from farm to fork to landfill. National Resource Defense Council issue paper. IP:12-06-B, August 2012. www.nrdc.org/food/files/wasted-food-IP.pdf

22 Gunders, Dana. 2012.

23 Shute, Lindsey L., Avery Anderson, Hannah Bernhardt, Tierney Creech, Severine Fleming, Emily Oakley & Benjamin Shute. 2011. Building a future with farmers: Challenges faced by young, American farmers and a national strategy to help them succeed. www.youngfarmers.org/reports/Building_A_Future_With_Farmers.pdf

24 Shute, L.L., et al 2011

25 Environmental Working Group. Crop insurance badly in need of reform. farm.ewg.org

26 Hamerschlag, Kari. No Date. Farm subsidies in California: Skewed priorities and gross inequities. Environmental Working Group. farm.ewg.org/pdf/california-farm.pdf

27 Food and Water Watch. 2012. Public research, private gain: Corporate influence over university agricultural research. documents.foodandwaterwatch.org/doc/PublicResearchPrivateGain.pdf

- i. Iowa State University Entomology: 52% (Syngenta, Bayer)
- ii. University of California Nutrition: 49% (Mars, Novo Nordisk)
- iii. Texas A & M Soil and Crop Sciences: 56% (Monsanto, Cotton Inc., Pioneer Hi-Bred)

3. Political Systems

- a) Different levels of government regulate various aspects of the food system, and can affect efforts to develop a more sustainable food system. For example, federal regulations affect:
 - i. Food safety: There are concerns that regulations such as the Food Safety Modernization Act may favor industrial agriculture and make farming untenable for smaller-scale growers
 - ii. GMO rules: Current rules governing genetically modified crops favor GMO producers over consumers concerned about GMO products; e.g., there is currently no labeling requirement for foods containing genetically modified ingredients
 - iii. Organic certification: The National Organic Program (NOP) regulates and certifies organic producers; many states also have certification and regulation programs. Both often offer “cost share” programs to reduce the economic impact of certification on smaller-scale producers.
- b) The Farm Bill is a multi-faceted federal bill that is revised and reauthorized every 5 years. The Farm Bill has a tremendous impact on the food system by providing (or withholding) funding for programs such as crop insurance and other subsidies via price and income supports; nutrition programs for low-income Americans such as the Supplemental Nutrition Assistance Program (SNAP, also referred to as food stamps) and federally funded school lunch programs; conservation programs such as the Conservation Stewardship Program and Environmental Quality Incentives Program (EQIP); and efforts to support new farmers, such as the Beginning Farmer and Rancher Development Program. (see National Coalition for Sustainable Agriculture, sustainableagriculture.net, for more information.)

4. Environmental/natural resources

- a) Biodiversity
 - i. 91% of the wetlands in California have disappeared ²⁸
 - ii. Overall, U.S. commercial beekeepers have been losing about a third of their hives each winter between 2006 and 2012, which are unprecedented losses ²⁹
 - iii. “The ‘human footprint’ analysis of Sanderson et al. (2002) estimated that 80–90% of lands habitable by humans is affected by some form of productive activity” ³⁰

28 Scherr, Sara J., and Jeffrey A. McNeely. 2008. Biodiversity conservation and agricultural sustainability: Towards a new paradigm of ‘ecoagriculture’ landscapes. *Philosophical Transactions of the Royal Society B*. Vol (363), No. (1491). rspb.royalsocietypublishing.org/content/363/1491/477.full#ref-133

29 Holland, Jennifer S. 2013. The plight of the honeybee: Billions of dollars—and a way of life—ride on saving pollinators. *National Geographic Daily News*. news.nationalgeographic.com/news/2013/13/130510-honeybee-bee-science-european-union-pesticides-colony-collapse-epa-science/

30 Scherr and McNeely. 2008. op. cit..

b) Climate change

- i. Agricultural production of greenhouse gases has generally increased between 2008 and 2012³¹
 - Carbon dioxide (CO₂) from ammonia production (80% of which is for agricultural use/ fertilizer) is up
 - Manure management has only increased output of nitrous oxide (N₂O) slightly, but is putting out much more methane (CH₄), a major greenhouse gas
 - Methane from field burning of agricultural residues has remained approximately the same
 - However, there has been a decrease in CO₂ output from land remaining in cropland

5. Environment/Inputs

- a) Critical fertilizer resources are nearing the peak of easy and accessible production. As demand continues to rise and production decreases, these resources get increasingly expensive, pushing up the price of food.
 - i. Phosphorous is a required ingredient for growing all plant life. It cannot be manufactured. It is found primarily in human and animal waste, but for industrial agriculture it is primarily mined. The U.S. has 25 years of phosphate rock left, and imports much from Morocco (which has close to 85% of the phosphate rock).³²
 - ii. Synthetic nitrogen fertilizer production requires natural gas. Thus, fertilizers are subject to price fluctuations, as are other fossil fuels used in agriculture.³³
- b) Topsoil in the U.S. is disappearing 10 times faster than it can be replaced³⁴
- c) Freshwater resources are decreasing in the U.S., at a time when there are more demands being put on water use, and when, it is predicted, there will be more droughts and changing precipitation patterns due to climate change. In the U.S., agriculture uses approximately 40% of the water from surface and ground water sources for irrigation.³⁵
- d) Seeds: Most of the U.S.'s primary commodities are grown from genetically engineered seeds: 93% of soybeans, 88% of cotton, 86% of corn and 54% of canola.³⁶ See Unit 1.4, Supplement 1, for additional discussion of genetically engineered seeds.

31 US EPA. 2014. Inventory of U.S. greenhouse gas emissions and sinks: 1990-2012. www.epa.gov/climatechange/Downloads/ghgemissions/US-GHG-Inventory-2014-Main-Text.pdf

32 Cho, Renee. 2013. Phosphorus: Essential to life – Are we running out? *Phys.org*. 4/2/13. phys.org/news/2013-04-phosphorus-essential-lifeare.html

33 Funderburg, Eddie. 2001. Why are nitrogen prices so high? The Samuel Roberts Nobel Foundation. www.noble.org/Ag/Soils/NitrogenPrices/Index.htm

34 Lang, Susan S. 2006. "Slow, insidious' soil erosion threatens human health and welfare as well as the environment, Cornell study asserts." *Cornell Chronicle*. Cornell University. March 20, 2006. www.news.cornell.edu/stories/2006/03/slow-insidious-soil-erosion-threatens-human-health-and-welfare

35 Megdal, Sharon B., Richard Hamann, Thomas Harter, James. W. Jawitz, and J. Michael Jess. 2009. "Water, people, and the future: Water availability for agriculture in the United States." CAST Issue Paper, No. 44. November 2009. www.cast-science.org/download.cfm?PublicationID=2950&File=f030727a50f063579836506a748341f2f310

36 Freese, B. and G. Kimbrell. 2013. Seed giants vs. U.S. Farmers. Center for Food Safety & Save Our Seeds

Discussion Questions, Lecture 3

DEVELOPMENT OF U.S. AGRICULTURE, LECTURE 3

- 1) Why do you think it is important to understand or study the food system?
- 2) What are other components of a food system, that aren't discussed here?
- 3) What parts of the food system are you most interested in learning more about? Why?
- 4) How many people (or roles they play in the food system), would you guess have been a part of the food you ate this morning? Describe all the roles you think were involved.
- 5) What are some of the most concerning aspects of the current, dominate U.S. food system?
- 6) What might an alternative food system look like? See Nourish website for more discussion questions: www.nourishlife.org/pdf/Food_System_Map_Study_Guide.pdf

References & Resources

SUGGESTED READINGS FOR LECTURES 1 & 2 FOR STUDENTS (DESCRIBED BELOW)

- Buttel, Frederick H. and Howard Newby, eds. 1980
- Clapp, Jennifer. 2012. .
- Cochrane, Willard W. 1993.
- Gardner, Bruce L. 2002.
- Heffernan, William D. 1998.

SUGGESTED READINGS FOR STUDENTS FOR LECTURE 3 (DESCRIBED BELOW)

- Ingredients of the Food System. 2010.
- Millstone, Erick and Tim Lang. 2008.

PRINT REFERENCES & RESOURCES

Berlan, Jean Pierre and Richard C. Lewontin. 1986. The Political Economy of Hybrid Corn. *Monthly Review* 38(3), 35-47.

Buttel, Frederick H. and Howard Newby, eds. 1980. *The Rural Sociology of the Advanced Societies: Critical Perspectives*. Montclair, N.J.: Allanheld Osmun.

A pivotal collection of essays covering a range of social and environmental issues in modern agriculture. This book and its contributors would help to define and direct a new, richly critical sociology of agriculture. Especially Newby and Buttel, "Toward a critical rural sociology;" and Buttel, "Agriculture, environment, and social change: Some emergent issues."

Center for Sustainable Systems. 2012. *U.S. Food System Factsheets*. University of Michigan, Ann Arbor, MI. css.snre.umich.edu/css_doc/CSS01-06.pdf

This fact sheet provides other pieces of information that make up the food system.

Clapp, Jennifer. 2012. *Food*. Cambridge, UK: Polity Press.

This book describes how the current global food system developed, by exploring issues such as corporate influence, skewed trade rules, and financial system changes.

Cochrane, Willard W. 1993. *The Development of American Agriculture: A Historical Analysis*. Minneapolis: University of Minnesota Press.

An excellent critical history of U.S. agricultural development. Full of insightful analysis and commentary as well as exhaustive history. Introduces the concept of the "technology treadmill" as a major problem in U.S. agriculture.

Danbom, David B. 1995. *Born in the Country: A History of Rural America*. Baltimore: Johns Hopkins University Press.

An important history of the effects of agricultural policy and development on rural life and rural people. See especially Chapter 11, "The production revolution and its consequences."

FitzSimmons, Margaret. 1990. The social and environmental relations of US agricultural regions. In *Technological Change and the Rural Environment*. London: Philip Lowe et al. London, David Fuller.

Friedmann, Harriet. 1993. The political economy of food: a global crisis. *New Left Review*: 197.

A succinct history, overview and contextualization of trends in global food trade. Discusses national agriculture and trade policies in the context of international geopolitical relations; and their effects on agricultural development.

Gardner, Bruce L. 2002. *American Agriculture in the Twentieth Century: How It Flourished and What It Cost*. Cambridge, MA: Harvard University Press.

A straightforward, uncritical, but data-intensive and encyclopedic overview of trends in American agricultural development during the 20th century. Full of valuable charts and graphs. An excellent reference.

Goldschmidt, Walter R. 1978. *As You Sow: Three Studies in the Social Consequences of Agribusiness*. Montclair, N.J.: Allanheld Osmun.

A groundbreaking and often-cited study of two agricultural communities in California with different structures of farm ownership. Goldschmidt found that concentration in ownership and corporate control of farms

had negative impacts on such indicators of social welfare as income distribution, civic participation, and quality of education.

Goodman, David, Bernard Sorj, and John Wilkinson. 1987. *From Farming To Biotechnology: A Theory of Agro-Industrial Development*. Oxford, New York: Basil Blackwell.

An integrated theory of the nexus of research, policy, technological development, and capitalist penetration in agricultural development. Considered a seminal work in modern political economy of agriculture.

Goodman, David. 1991. Some recent tendencies in the industrial reorganization of the agro-food system. In *Towards a New Political Economy of Agriculture*. William Friedland, ed.). Boulder, CO: Westview.

A distillation and update of the concepts developed in From Farming to Biotechnology (Goodman et al. 1987); and an overview of the encroachment of industrial capital into the agrofood system.

Heffernan, William D. 1998. Agriculture and monopoly capital. *Monthly Review* 50: 46 (July/August).

An analysis of who controls the agro-food system. A discussion of the historical and modern trends toward oligopoly and monopoly that characterize firms operating in the agro-food sector, and the consequences for the structure and development of agriculture. This topic is Heffernan's specialty.

Heffernan, William D. 2000. Concentration of ownership and control in agriculture. In *Hungry for profit: The agri-business threat to farmers, food, and the environment*. *Monthly Review Press*, pp 61–75.

Hendrickson, Mary, and William Heffernan. 2007. Concentration of agricultural markets. www.foodcircles.missouri.edu/07contable.pdf

Hendrickson, Mary, and William Heffernan. 2002. Concentration of agricultural markets. www.foodcircles.missouri.edu/CRJanuary02.pdf

Hightower, Jim, and Agribusiness Accountability Project. Task Force on the Land Grant College Complex. 1973. *Hard Tomatoes, Hard Times; A Report of the Agribusiness Accountability Project on the Failure of America's Land Grant College Complex*. Cambridge, MA: Schenkman Pub. Co.

A high-profile critique of the research and education agenda of the land-grant university complex in the U.S. Hightower argues that the Land Grant Universities serve and promote large-scale, corporate agriculture at the expense of small-scale, family farmers, and have actively contributed to the decline in family-scale agriculture.

Holt-Giménez, Eric, and Raj Patel. 2009. *Food Rebellions! Crisis and the Hunger for Justice*. Oxford, UK: Pambazuka Press.

This book explores the reasons for the 2008 food crisis, which still continues for many. It looks at both the immediate and underlying causes of hunger in the food system. It provides a concise and clear overview of the issues involved.

Hurt, R. Douglas. 1994. *American Agriculture: A Brief History*. Ames, IA: Iowa State University Press.

A good, but uncritical, survey of American agricultural development with an emphasis on pre-World War II history.

James, Harvey S., Jr., Mary Hendrickson, and Philip H. Howard. 2013. Networks, Power and Dependency in the Agrifood Industry. Pp. 99-126 in *The Ethics and Economics of Agrifood Competition*, Harvey S. James, Jr., ed. New York: Springer.

Kloppenburg, Jack R. 1988. *First the Seed: The Political Economy of Plant Biotechnology, 1492–2000*. Cambridge; New York: Cambridge University Press.

A gripping and well-documented analysis of the “commodification of the seed.” Kloppenburg starts from the thesis that the seed is an important locus of power and autonomy in agriculture, and goes on to show how control over the seed has been transferred from the public domain—farmers and peasants—to a handful of large private corporations; and this transferral's effects on the structure of the agrifood system.

Lobao, Linda M. 1990. *Locality and Inequality: Farm and Industry Structure and Socioeconomic Conditions*. Albany: State University of New York Press.

A Marxian analysis of the structural economic conditions governing agricultural development.

Lyson, Thomas A. 2004. *Civic Agriculture: Reconnecting Farm, Food, and Community*. Medford MA: Tufts University Press.

Mann, Susan A., and Jones M. Dickinson. 1978. Obstacles to the development of a capitalist agriculture. *Journal of Peasant Studies*, Vol. 5, No. 4: 466–481.

McConnell, Grant, and American Farm Bureau Federation. 1969. *The Decline Of Agrarian Democracy*. New York: Atheneum.

A history and analysis of agrarian populist movements in the U.S. Good discussion of farmers' resistance strategies in the face of increasingly powerful corporate control over the food system.

McWilliams, Carey. 1935. *Factories in the Fields: The Story of Migratory Farm Labor in California*. Berkeley, CA: University of California Press.

Excellent and critical historical analysis of farm labor in California. Special emphasis is placed on the ways in which ethnicity and the seasonality of labor demand combine with industrial capitalism's infiltration of agriculture to create an unjust labor system.

Millstone, Erick, and Tim Lang. 2008. *The Atlas of Food: Who Eats What, Where and Why*. Revised and Updated. Berkeley, CA: University of California Press.

This is an excellent summary of the global food system. The book's intention is to describe the global food system, and to provide readers with the background about how this system came to be and where it is likely to go in the future. It explores the current situation, identifying important trends and explores how it may be improved.

National Farm Worker Ministry. No date. Timeline of Agricultural labor in the U.S. nfwm.org/education-center/farm-worker-issues/timeline-of-agricultural-labor/

Patel, Raj. 2007. *Stuffed and Starved*. Brooklyn, NY: Melville House Publishing.

Excellent book that provides an overview of current food system and the results of the choices made by corporations, governments, farming communities and others. Topics covered include farmer suicides, migration, trade agreements and development, agribusiness

winnings, control of the seed, and the example of soybeans – where all the factors described come together. Also includes a focus on the power of the supermarket industry and how people are constrained as consumers.

Pollan, Michael. 2006. *Omnivore's Dilemma: A Natural History of Four Meals*. New York, NY: Penguin Books.

Schafer, Joseph. 1936. *The Social History of American Agriculture*. New York, NY: The Macmillan Company.

A dated but entertaining history of pre-chemical American agriculture, with an emphasis on social organization.

Tansey, Geoff, and Tony Worsley. 1995. *The Food System: A Guide*. London: Earthscan Publications Ltd.

This book's focus is on understanding the food system. It explores what a food system looks like, who are the players and what are the various mechanisms of control.

Wells, Miriam J. 1996. *Strawberry Fields: Politics, Class, and Work in California Agriculture*. Ithaca, NY: Cornell University Press.

Worster, Donald. 1990. Transformations of the Earth: Toward an agroecological perspective in history. *Journal of American History* 76(4): 1087.

A preeminent environmental historian's discussion of agriculture as the fundamental way in which humans relate to, transform, and are themselves transformed by their environments. A call for the reorientation of agriculture towards a more ecologically informed approach.

CALIFORNIA AND COASTAL CALIFORNIA RESOURCES

Daniel, Cletus E. 1981. *Bitter Harvest: A History of California Farmworkers, 1870–1941*. Berkeley, CA: University of California Press.

Jelinek, Lawrence J. 1979. *Harvest Empire: A History of California Agriculture*. San Francisco: Boyd & Fraser.

Lydon, Sandy, and Linda Yamane. 2002. The challenges of interpretation: A conversation. In *A Gathering of Voices: The Native Peoples of the California Central Coast*, Linda Yamame, ed. Santa

Cruz County History Journal #5. Santa Cruz, CA: Museum of Art & History.

This article contains some descriptions of Native American's experiences in agriculture in the Central Coast.

Walker, Richard. 2004. *The Conquest of Bread: 150 Years of Agribusiness in California*. New York: The New Press.

Wise, Timothy. 2011. *Still Waiting for the Farm Boom: Family Farmers Worse Off Despite High Prices*. Global Development and Environment Institute. Boston: Tufts University. www.ase.tufts.edu/gdae/Pubs/rp/PB11-01FarmIncomeMarch2011.pdf

WEB-BASED RESOURCES

Howard, Phil. Information Graphics.

www.msu.edu/~howardp/infographics.html

Excellent information graphics depicting concentration in the food system.

National Sustainable Agriculture Coalition (NSAC)

sustainableagriculture.net

NSAC is an advocacy coalition of grassroots organizations that promotes opportunities for small and medium-scale growers and beginning farmers, encourage sustainable and organic practices, and advocates for expanded on-farm research for sustainable agriculture. Their website is an excellent resource for information on current legislative efforts affecting sustainable agriculture.

CURRICULUM RESOURCES

Center for Ecoliteracy. Nourish Curriculum Guide: What's the Story of Your Food?.

www.nourishlife.org/teach/curriculum/

The nourish curriculum includes a 26-minute movie, and a series of lesson plans/activities for students to participate in. The curriculum is aimed at students from later elementary school through early high school.

Discovering the Food System: An Experiential Learning Program for Young and Inquiring Minds

www.discoverfoodsys.cornell.edu/

This curriculum provides experiential activities to learn about the food system from a hands-

on perspective. By starting "in our backyard," youth learn about how the food system works, who is a part of it, and how they fit within and influence it. It is meant for grades 7 thru 12, but could also work well for college courses.

Gault, Ryan. 2013. *Community and Regional Development (CRD) 20: Food Systems*. Syllabus. UC Davis. Fall 2013.

hcd.ucdavis.edu/faculty/webpages/galt/personal/Galt_Faculty_Page/CRD_20_files/CRD_20-Syllabus.pdf

Gault, Ryan, and Damian Parr. 2013. *Lab Manual Version 3.3 for Food Systems*. UC Davis. Fall 2013.

hcd.ucdavis.edu/faculty/webpages/galt/personal/Galt_Faculty_Page/CRD_20_files/CRD%2020%202013%20Lab%20Manual%20Version%203_3.pdf

Sustainable Agriculture Education Association (SAEA)

sustainableaged.org/ (see "Curriculum Library")

Starting in 2014, SAEA will roll out a place where educators can share syllabi, class exercises, assignments, and information about their degree programs.

Teaching the Food System—A Curriculum

www.jhsph.edu/research/centers-and-institutes/teaching-the-food-system/curriculum/

This is an excellent resource for teaching about a number of food system topics, such as what a food system is, the history of food, agriculture and ecosystems, food processing, food distribution, diet and hunger and food security.

ADDITIONAL FOOD SYSTEM GRAPHICS

- infothread.org/Foods/Global%20Food%20System.jpg
- vodaplan.com/wp-content/uploads/2011/08/SLC-Food-System-1.jpg
- www.vsjf.org/assets/files/tables_figures/execsummary/1-Food%20System%20Diagram.jpg

For pictures of sub-components of the food system, go to:

www.msu.edu/~howardp/infographics.html

VIDEO RESOURCES

The Food System: An Overview

www.tansey.org.uk/news/FStalk.html

This 30-minute video by Geoff Tansey provides a succinct overview of today's food system. The video is divided into five sections, which can be watched individually and discussed by the group, or watched in its entirety. The sections include: the basics, key actors, a changing world, tools for control, and food policy and practice.

What's on Your Plate?

www.youtube.com/watch?v=AQIG710-mdw&feature=youtu.be

This 12-minute illustrated video, commissioned by the University of Vermont, introduces the issues in the dominant food system. It describes the food system in a manner that supports Lecture 3 of this unit, from 3:09 to 7:40.

Appendix 1: Food System Graphics

Graphic #1: The Food System and Its Components

Food System



Developed by the Center for Agroecology & Sustainable Food Systems (CASFS).

Appendix 1 (cont.): Food System Graphics

Graphic #2: The Food System Model

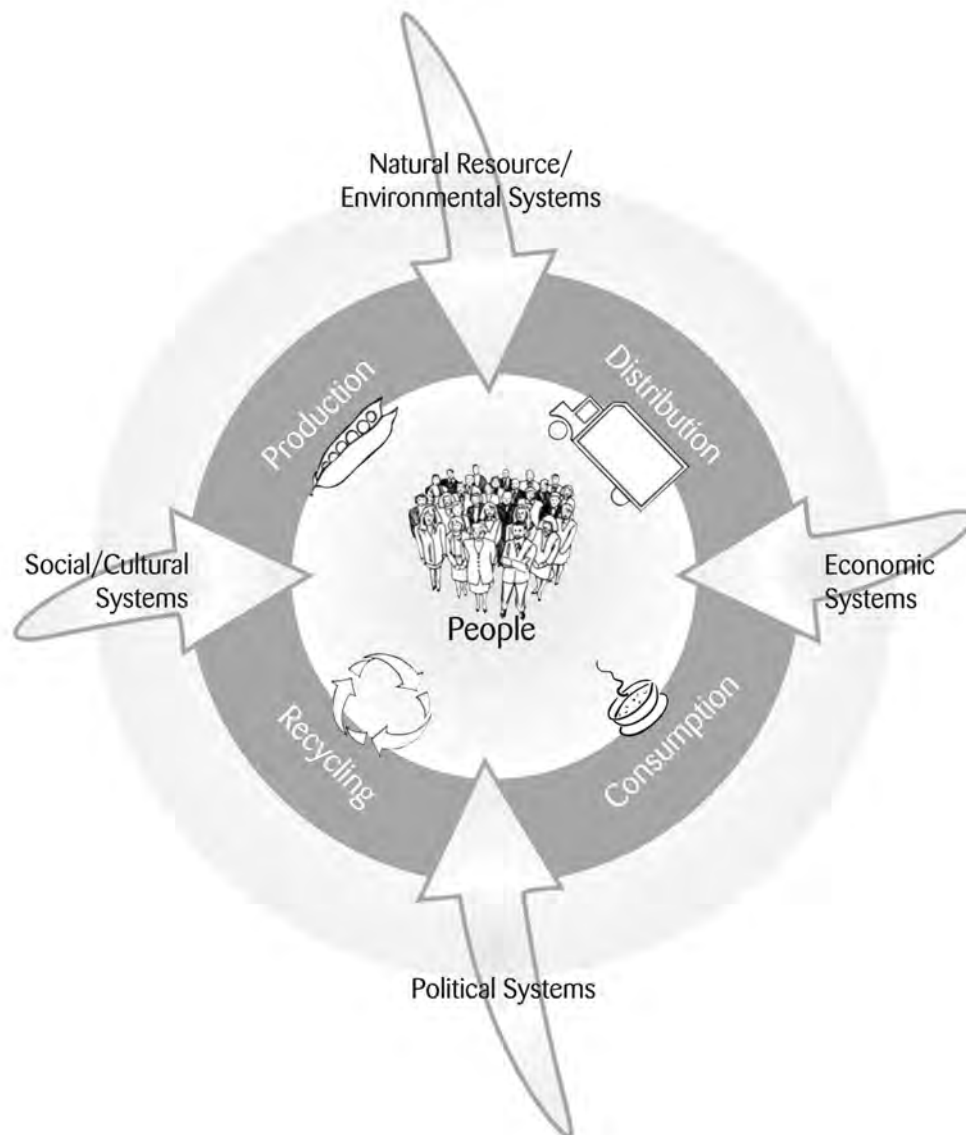

This graphic, developed by the Food Systems Consortium, is published in the 2005 San Francisco Collaborative Food System Assessment. www.sfgov3.org/Modules/ShowDocument.aspx?documentid=780
Used by permission.

Appendix 1 (cont.): Food System Graphics

Graphic #3: Nourish Food System Map

Nourish Food System Map

What's Your Relationship to Food? Look Closer.

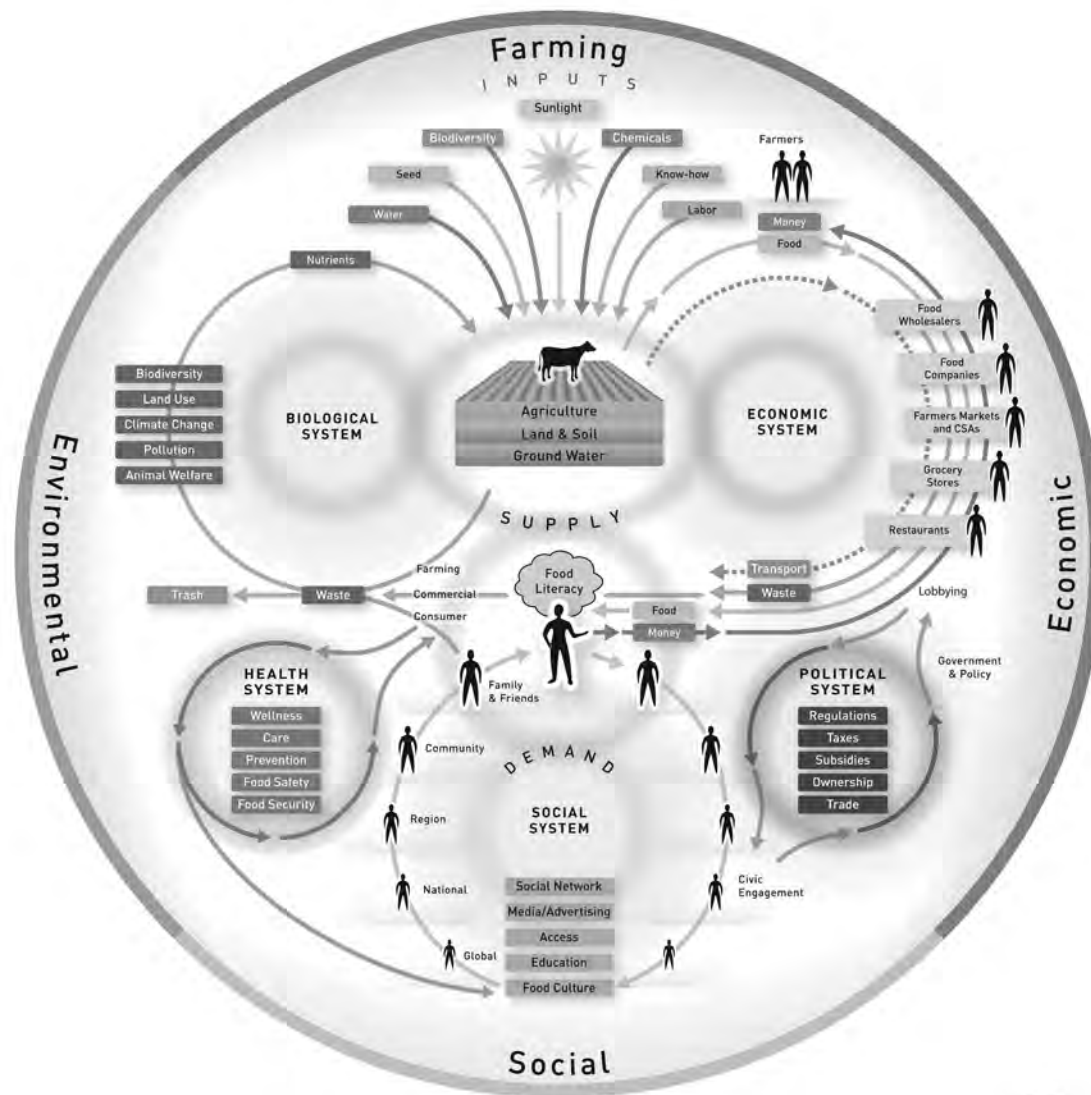

www.nourishlife.org
copyright © 2014 WorldLink



Copyright WorldLink, All rights reserved. www.nourishlife.org. Used by permission.

Social Issues in Current U.S. Agriculture

Introduction	33
Lecture 1: Social Issues in U.S. Agriculture—Labor	35
Lecture 2: Social Issues in U.S. Agriculture— Concentration and Health	40
Discussion Questions, Lectures 1 and 2	46
References and Resources	47

Introduction: Social Issues in Current U.S. Agriculture

UNIT OVERVIEW

This unit introduces some of the significant social issues and social consequences of the development of U.S. agriculture. The unit's overarching goal is to convey to students how agricultural decisions and development impact people and social structures. This section examines the impact of consolidation and concentration of ownership on farmers and beyond, the impact to workers in the food system, and the effects on the rest of the population (food insecurity and health issues).

Lecture 1 examines social issues in the current food system in greater detail, starting with labor. The status of a majority of food workers, including farmworkers, food processors, and those in the food service industry are reviewed and the reasons for their current situation are explored.

Lecture 2 examines the social consequences of the current food system by focusing on the effects of concentration of ownership and consolidation, and the impact of the current food system on human health (e.g., food insecurity, obesity, antibiotic resistance) and other areas. The effects of recent food system changes on farmers and consumers are explored, along with problems associated with an increasing concentration of power.

MODE OF INSTRUCTION

- > LECTURES (2 LECTURES, 50 MINUTES EACH)
The lecture outlines cover the social issues associated with the evolution and current organization of the U.S. food system. References given in the outlines are described in the References and Resources section.

LEARNING OBJECTIVES

CONCEPTS

- The U.S. food system, as it has been developed and as it is now, has many impacts on people
- The extent to which the current system put the risks and burdens of agricultural production on those with the fewest choices and least resources
- The impacts of consolidation in the food system
- The basic information about how hunger continues, even in a system of agricultural overproduction
- How the current food system impacts human health

Lecture 1: Social Issues in U.S. Agriculture—Labor

A. Overview

1. The current food and agriculture system produces certain “externalities”—the social and ecological consequences (“hidden costs” of production) that have resulted from changes in the food system and for which no individuals or institutions are held legally or financially accountable
2. The externalized social costs of production are, among others: Increases in the concentration of ownership over the means of food production; the associated declines in small-farm viability and the life quality indicators of rural agricultural communities; declines in the working conditions and life quality of agricultural laborers; continued consumer and farmworker exposure to unsafe levels of pesticides; and the persistence of hunger in the context of the overproduction of food

B. Issues with Labor in the Food System

(Main sources: Allen and Melcarek 2013; Jayaraman 2013; Thompson and Wiggins 2002; VanDeCruze and Wiggins 2008)

1. The food system workforce
 - a) People working in the food system include those who grow, process, distribute, and sell food. They also include unions, investors, input suppliers, researchers, government employees, and non-governmental organizations (NGOs). Workers in these groups range from owners of business to hourly hired labor.
 - b) According to a National Commission on Agricultural Trade and Export Policy report (1986), around 23% of the workforce is involved in production agriculture and jobs that make up the food system as a whole
 - c) The Bureau of Labor Statistics (BLS) 2012 survey estimates that the hired workers in the food chain— farmworkers, food processing workers, food preparation and serving workers—comprise 10.4% of the total US workforce. However, their agricultural labor numbers are far below that of the USDA's count, and front line supervisors are not included. Thus, the true percentage is likely higher than reported here.
 - d) A BLS survey estimates that food preparation and serving workers comprise approximately 8.9% of the workforce, with 11.5 million workers. They also estimated that there were 720,970 food processing workers, and 372,060 meat processing workers.
 - e) As of 2006, there were an average of just over a million hired farmworkers—which is a third of the people working directly in agriculture. The other 2 million were self-employed farmers and family members (unpaid); (Kandel 2008).
 - f) According to a National Agricultural Workers survey, 83% of farmworkers identify themselves as part of an Hispanic or Latino group; 8% identified as indigenous, American Indian or Alaskan native; 4% identified themselves as Black/African-American (U.S. Department of Labor, No Date: a)
 - g) Many of these jobs are required to produce our food. Farmworkers are necessary for the production of fresh fruits and vegetables, which mostly cannot be harvested by machines. Meat consumption requires human labor despite the machinery available for meat processing.

2. Underpaid and unrepresented

- a) A large portion of jobs in the food chain, what we will refer to as food system jobs, pay very low wages. These include food service, processing, and farmworkers.
 - i. Farmworkers have the highest poverty rates among other workers in the U.S. Their income ranges from \$10,000–\$18,000 per year, but has also been reported at a median of \$7,500.
 - ii. Of all the lowest paying occupations in the U.S., 7 of the 10 jobs are in restaurant positions
 - iii. The average salary for those in the food processing industry (which includes bakers, butchers, meat packers, etc.) was less than half of the salary average for what all occupations earned
 - iv. Few in these jobs have paid sick days or health benefits
- b) Most of these jobs are also unrepresented, meaning that they don't have collective bargaining as a source to help balance the power and interests with very large organizations
 - i. Only 16% of food processors were reported by the U.S. Department of Labor to have union contracts
 - ii. As of the early 2000s, fewer than 10% of workers in strawberry fields were unionized with the United Farm Workers (Schlosser 2003)
- c) These jobs are often low wage due to special labor laws
 - i. Federal law only requires a minimum cash wage for tipped employees of \$2.13 per hour. Most states mandate a higher wage, but many don't (United States Department of Labor 2014). In fact, half of the states allow the wage to be between \$2.13 and \$3.00. (Jayaraman 2013).
 - ii. Farmworkers were excluded from national labor protection laws until 1978, when those on larger farms were finally included in the Fair Labor Standards Act. However, they are still not included in overtime pay requirements. Farmworkers on small farms are excluded from a minimum wage as well (United States Department of Labor N.D.).
- d) It is not uncommon for food system workers to report that their wages have been shorted (they were not paid what they earned) or that overtime was withheld
- e) People of color often make less than whites. This holds true across the production, processing, distribution, and service sectors. People of color are also over-represented in the low paying food system jobs (Yen Liu and Apollon 2011).
- f) Similarly, women have earned less than men in food system jobs, such as farming, food processing and food services

3. Health impacts

These low-wage jobs have a number of health impacts associated with them

- a) Food insecurity
 - i. According to California Institute for Rural Studies research, 45% of Fresno County farmworkers, and 66% of Salinas Valley farmworkers are food insecure, despite living in two of the most agriculturally productive regions in the U.S. (Wadsworth 2014)
 - ii. For those farmworkers who live in rural areas and unincorporated regions, there is little public transportation or access to healthy foods. Given that farmworkers have low rates of car ownership (39%), it makes access to food even more difficult. Being able to afford food is also difficult, considering the low wages they earn (Wadsworth 2014).
 - iii. See Lecture 2 in this unit for more information on food security

b) Pesticides

- i. 4080 cases of sickness from pesticide residues were reported in California between 1982–2007. Research shows that cases of pesticide exposure often go unreported. Oxfam American estimates that 300,000 U.S. farmworkers are sickened each year from pesticides.
- ii. Much exposure happens when workers are doing routine tasks that don't include applying pesticides. Farmworkers contact pesticides by breathing them, having them spilled or sprayed accidentally, or by coming in contact with plants with residues.
- iii. A North Carolina study found that being sprayed with pesticides or being aware of strong chemical smells while working were reported by half of the respondents
- iv. Children of farmworkers are often exposed to pesticides from working alongside their parents, living close to fields that are sprayed, and from residue that parents bring home on clothes, etc. Prenatal exposure has been associated with neurodevelopment problems, such as lowering of IQ, brain function, reflexes, and ability to connect (autism and Asperger-type conditions; Frienkel 2014).
- v. Pesticides can affect people in acute ways, causing headaches, nausea, vomiting, dizziness, rashes, and burns. They can also cause problems over time, leading to cancer or sterility. Birth defects and other reproductive risks are also problems.

c) Injuries

- i. Reported Injuries and illness are much higher for food system workers. The average rate for all private industry in 2006 was 4.4 injuries per 100 full time workers. For crop production the rate was 5.8, poultry processing was 6.6, and animal slaughtering (except poultry) was 12.5. The disability rate for farmworkers is three times that of the general population.
- ii. Farmworkers are subject to heat exhaustion, musculoskeletal issues (back problems are common), and accidents with ladders and machinery. Cuts, scrapes, and rashes are also issues.
- iii. Food processing involves using heavy machinery and cutting implements, and doing repetitive work. Food processing workers have high rates of carpal tunnel syndrome, which can be disabling. Animal slaughtering (excluding chickens) has lacerations as the most common injury—as most people on the quick-moving disassembly line are using a knife. Those processing animals are also exposed to viruses, bacteria, and other substances that contribute to respiratory diseases.

d) Access to health care

- i. Once injured, most food system workers have barriers to receiving health care—with few having health insurance or paid sick leave (the Affordable Care Act may provide or increase benefits to some [Farmworker Justice 2012]). They often lack needed money to pay for treatment and fear losing wages by taking time off to seek treatment.
- ii. Some are discouraged from seeking outside medical care to keep injury rate statistics and costs down (see Schlosser 2001, Chapter 8 for meat packers stories)
- iii. For farmworkers, workers compensation does not necessarily cover them in all states. Additionally, getting access to medical care is less likely due to lack of transportation and being unaware of available sources.

4. Food system workers' experience

(see Rothenburg, Chapter 1, for individual farmworker stories, Jayaraman 2013 for food service industry workers, and Schlosser 2001, Chapter 3 for fast food worker and Chapter 8 for meat packing worker stories)

a) Living situations

- i. For farmworkers, overcrowding in dwellings is a common issue. Two different surveys (one from 1980 and one from the late 1990s) show that 85% and 60% of units are filled beyond capacity. This means that farmworkers were often sleeping in living rooms or on kitchen floors.
- ii. Research also reports significant structural damage to dwellings. One third showed sagging features (walls, ceilings, floors) or holes in the roof or both.
- iii. Given that one study showed that their average salary was around \$850 per month, paying the average \$200 per month for rent is a large portion of one's income. The average rent on a mobile home or duplex was at or just above \$425. This situation doesn't allow people to have much money left for food, clothing, and other necessities.

b) Working conditions

- i. Farmworkers do repetitive tasks for long periods of time, either bending over harvesting or reaching on ladders. This work is often done in extreme temperatures, including summer heat and autumn cold.
 - ii. Food processing workers—particularly slaughterhouse workers—are subject to a variety of difficult working conditions. Many work at 40 degrees to keep the meat cool, while making many cuts per minute with knives. When people get injured they are encouraged not to go to the doctor, and treated better if they don't. Injuries are frequently under reported.
 - iii. For restaurant workers, being overlooked for advancement in pay or position rank based on ethnicity or gender, is commonly reported
 - iv. Reports of sexist comments and harassment are common from female food system workers across the types of work
 - v. Forced overtime and failing to pay overtime rates are also reported
 - vi. Meat packers in Colorado who have a major disability from an injury, such as loss of a body part, can only receive very limited compensation. They can get a maximum of \$36,000 for the loss of an arm, or up to \$4,500 for the loss of a finger. For unskilled and uneducated workers, these physical issues create a profound limitation on their future earning ability, which is not covered by these awards (Schlosser 2001).
- c) Despite the modest gains made during the 1960s–1970s with Cesar Chavez, agricultural labor remains poorly compensated, difficult, and dangerous work for millions of people

C. Factors That Contribute to Current Food Worker Situations

1. Long history of exploitation (VanDeCruze and Wiggins 2008; see also Unit 3.1, Lecture 1, History of U.S. Agricultural Development)
 - a) The growth of large-scale agriculture in the Southern states relied on the enslavement of Native Americans and Africans
 - b) Post-slavery, the sharecropping system was used widely in the South. Farmers would do the work in exchange for a small percentage of the crop, which usually went back to the land owner to cover debts, keeping people impoverished.
 - c) Farm laborers were often from dispossessed groups with few options, such as immigrants to the U.S. Having little political power and limited economic choices, they could not contest working conditions or pay.

2. Immigration policy, consolidation, and free trade agreements have helped to keep wages low
 - a) Significance of U.S. labor and immigration policies
 - i. Carey McWilliams' thesis on the ethnic succession of agricultural labor: That the U.S. government has designed immigration policies that introduce new (ethnic-based) group of workers who are willing to work for low wages and live in sub-standard conditions
 - Organizing efforts of immigrants are undermined through the repeated introduction of new groups of workers (of a different ethnicity) to replace "recalcitrant" workers who protest working conditions (see McWilliams 1935, Introduction)
 - Examples of this cycle: Chinese, Japanese, Punjabi Indians, Dust-Bowl migrants, Filipino, and Mexican immigrant labor throughout the 20th century
 - ii. Farmworkers from other countries who get documentation as part of the H-2A program are not protected by the federal legislation that oversees farmworker labor. They do not have the right to bargain collectively or unionize (Ahn et al 2004).
 - iii. It is estimated that half of all hired farmworkers have an unauthorized immigration status (Kandel 2008). It is also estimated that 40% of food service workers in New York City are undocumented (Jayaraman 2013).
 - b) The role of consolidation
 - i. Consolidation of retail puts the larger corporations in the driver's seat, where they can set prices, particularly before the crop is even planted. This puts the risk of farming on the growers, pressuring them to cut costs—of which labor forms a significant part, particularly for fruits and vegetables (Ahn et al 2004).
 - ii. Meat slaughtering and packing plants used to be unionized and offer decent-paying jobs. After one large company, IBP, mechanized the slaughtering process and moved out of the urban areas (where union support was strong), and into rural anti-union states, they were able to cut worker pay. Being a large company, IBP then undercut other companies enough to drive them to do the same thing—go rural and depend on immigrant labor (Schlosser, 2001).
 - IBP, a slaughtering/meatpacking business, has an office in Mexico City advertising jobs in the U.S. and offering transportation to get there (Schlosser 2001)
 - c) The role of free trade—increasing immigration
 - i. Free trade agreements (North American Free Trade Agreement, NAFTA, and the General Agreement on Tariffs and Trade, GATT), World Bank requirements, and policies favoring big business cut much of Mexico's agricultural support to farmers, which dropped 90% in the first 7 years after the signing of the NAFTA agreement. Many subsistence farmers were forced to look for work elsewhere, including the factories and food work in the U.S. Additionally, since U.S. corn is still greatly subsidized, it can undercut the price of Mexican corn, further driving small subsistence farmers out of business and forcing them to look for wage jobs in the U.S. (Ahn et al 2004).
3. Low wages and seasonality of agricultural work together to further impact farmworkers' economic situation
 - a) Even though farmworkers might receive an hourly amount above minimum wage, much farm work is only needed seasonally, such as at planting and harvests times. They also are not paid for workdays cancelled due to rain or other weather issues. This leaves many farmworkers under- or unemployed for periods of time. They bear the costs of agriculture's intermittent and unpredictable nature (Rothenberg 1998).

Lecture 2: Social Issues in U.S. Agriculture— Concentration & Health

A. Impacts of Food System Concentration

1. Concentration across all sectors of the food system has increased greatly in the latter half of the 20th century (see Unit 3.1, Lectures 1 and 2). There are fewer and larger farms and many fewer farmers. Seed production, food processing, retail, and other sectors of the food system are often dominated by a handful of large companies.
2. Implications of concentration
 - a) Concentration of power: Production consolidation means consolidation of power and decision making. Such corporations “have considerable power in dictating how and where agricultural production takes place” (see Lyson and Raymer 2000, p. 200) as well as what is available in the marketplace. For example:
 - i. Walmart, being the largest retailer of food, exerts significant power. It has shifted the burden of risk to its suppliers, who now have to monitor the products they send, even on the shelves of Walmart itself. Walmart’s contracts are nonnegotiable—suppliers must simply accept what is offered without modification. If a supplier isn’t able to give all of the product agreed upon, or if there is an apparent discrepancy, the supplier agrees to be “fined.” Since Walmart is the biggest buyer for food processors, processors have to do what the company says (Hauter 2012).
 - ii. In a U.S. Department of Justice (DOJ) inquiry regarding seeds, corn and soybean growers have testified to that there is a lack of choice for seeds (both genetically modified and conventional), that they are paying much higher prices for seeds compared to the mid-1990s, and that their use of seeds is greatly restricted (U.S. DOJ 2012)
 - b) This concentration of power allows a few firms in an industry to work together to set prices in their favor in an uncompetitive manner
 - i. A USDA study found that big retailers had, in some cases, used their market power to set prices below competitive prices to suppliers, and above competitive prices to consumers (Dimitri, Tegene, and Kaufman 2003)
 - c) Extended influence: Members of the boards of directors of these multinational corporations frequently overlap, and typically have very similar educational and social backgrounds, thus exacerbating the problem of power concentration. Thus, much of the power in the food industry rests in the hands of relatively few individuals who tend to share common worldviews regarding the environment, labor, and food safety issues.
 - d) These very large corporations have significant influence over policy, often indirectly through networks and connections with organizations that promote political agendas. Other influence can be direct. For example:
 - i. “In January of 1987, Mike Harper told the newly elected governor of Nebraska, Kay Orr, that ConAgra wanted a number of tax breaks—or would move its headquarters out of Omaha. The company had been based in the state for almost seventy years, and Nebraska’s tax rates were among the lowest in the United States. Nevertheless, a small group of ConAgra executives soon gathered on a Saturday morning at Harper’s house, sat around his kitchen table, and came up with the basis for legislation that rewrote Nebraska’s tax code. The bill, drafted largely by ConAgra, sought to lower the state taxes paid not only by large corporations, but also by wealthy executives. Mike Harper personally stood to gain about \$295,000 from the proposed 30 percent reduction in the maximum tax rate on personal income” (Schlosser 2001, pp. 163-164).

- e) Large corporations are able to use the legal system in their favor. For example:
 - i. Monsanto's own contracts acknowledge that seed matter can drift to other crops, but claim they are then not responsible for the contamination. On the other hand, Monsanto is able to prosecute farmers that might have crops in their fields contaminated by pollen from Monsanto seed, as the law does not require that the company prove intent on the part of the farmer. Farmers don't generally have the resources to contest Monsanto in court (Freese and Kimbrell 2013).
 - f) Large corporations are also less affected by other balances of power. For example:
 - i. "In most businesses, a high injury rate would prompt insurance companies to demand changes in the workplace. But ConAgra, IBP and the other large meatpacking firms are self-insured. They are under no pressure from independent underwriters and have a strong incentive to keep workers' comp payments to a bare minimum. Every penny spent on workers' comp is one less penny of corporate revenue." (Schlosser 2001, p 184).
3. Other consequences of consolidation
- a) The number of small and mid-sized farms has been decreasing while the number of large farms increases (U.S. Department of Agriculture 2012 and U.S. Department of Agriculture 2007)
 - i. Those grossing less than \$100,000 (small farms) decreased 7%, from 1,847,663 in 2007 to 1,721,170 in 2012. Those grossing between \$100,000 and \$249,999 (often considered mid-sized farms), decreased 6%, from 147,500 in 2007 to 138,883 in 2012. These mid-sized farm decreased by 13% between 2002 and 2012.
 - ii. The number of large-scale farms has been increasing. Those grossing \$1,000,000 or more increased by 43%, from 55,509 in 2007 to 79,225 in 2012.
 - iii. Farms of 2000 acres or more have increased by 11%, from 27,092 in 2007 to 30,158 in 2012
 - b) Some growers are functionally being turned into "serfs" with unfair contract requirements. For example:
 - i. Much broiler production is embedded in a vertically integrated system, where the industry produces the baby chicks and the chicken feed, and then purchases the birds for slaughter. Farmers have to buy all the chicks and feed from the corporation, but must build their own facilities to house the birds and sell the birds back to the same corporation. These buildings can cost \$100,000 per unit. By the time they are paid off, they will need to be updated and modernized. Hence, it is difficult for the grower to get out of debt. Many farmers don't live close enough to more than one firm that buys birds, so they don't get to negotiate prices, but have to take what is offered. Additionally, companies can have informal agreements not to take on other companies' growers, thus leaving growers with few choices or options (Heffernan 1998).
 - c) This loss of farms appears to impact rural communities
 - i. In the late 1940s, researchers started exploring whether the increase in concentration in farms, and the decrease in small independent farms, had an impact on the communities' overall well being (Lobao and Meyer 2001)
 - ii. Early research demonstrated that having more small farms was related to community well being—a finding that resulted in a huge backlash by corporations; as a result, the USDA shut down its unit that commissioned the research (Lobao and Meyer 2001)
 - iii. The majority of later studies, including much larger quantitative studies, have shown similar results

4. Impacts on other areas
 - a) Labor impacts
 - i. The bargaining power of workers is diminished when there are few employers to choose from in an industry (Lynn 2010)
 - b) Consumer impacts
 - i. Consolidation is often claimed to make prices go down for consumers, but one recent study showed prices actually went up in 4 out of 5 cases (Ashenfelter and Hosken 2008)
 - c) Animal welfare
 - i. CAFOs severely restrict animals' movements, sometimes to the point of not even being able to turn around. This restriction can limit animals from expressing their normal behaviors, causing high levels of stress that can further impact physical health (Pew Commission on Industrial farm Animal Production 2009).
 - d) Environmental and health (see also Unit 3.3, Environmental Issues in Modern Agriculture)
 - i. Concentrated animal feeding operations (CAFOs) are replacing small and mid-sized animal production farms. CAFOs concentrate animal waste in much larger quantities than can be successfully handled by the land on which the operation resides. Waste products, including pathogens and nutrients, need special handling. Hormones, antibiotics, and pesticides also accumulate and can end up in local waterways (Pew Commission on Industrial farm Animal Production 2009).
 - ii. CAFOs have impacts on animal welfare and on human health—from increasing antibiotic resistance to polluting the local community's air and water; see Unit 3.3, Environmental Issues in Modern Agriculture, for more information (Pew Commission on Industrial farm Animal Production 2009)
 - iii. CAFOs also use large amounts of resources, from water to fossil fuels, much more than most other food production efforts (Pew Commission on Industrial farm Animal Production 2009)
 - iv. Consolidation in the seed industry has led to a decrease in seed diversity (Freese and Kimbrell 2013), which in the long term could negatively impact overall food security

B. Impacts to Health

The current food system in the U.S. impacts human health and nutrition in many ways

1. Food security (Allen and Melcarek 2013; Coleman-Jensen et al. 2013)
 - a) Not having enough to eat is associated with many serious health impacts (Troy et al 2011)
 - b) Worldwide, according to 2011–2013 statistics, 842 million people (12%) are considered undernourished. While better off than a majority of countries worldwide, there are many in the U.S. who do not have enough food to eat (Food and Agriculture Organization, no date).
 - c) "The World Food Summit of 1996 defined food security as existing 'when all people at all times have access to sufficient, safe, nutritious food to maintain a healthy and active life.'" Access means both that people have the physical ability to get food and the economic resources. It also includes that people have access to preferred foods (World Health Organization, no date).
 - i. Food security is made up of three factors:
 - "Food availability: Sufficient quantities of food available on a consistent basis.
 - Food access: Having sufficient resources to obtain appropriate foods for a nutritious diet.
 - Food use: Appropriate use based on knowledge of basic nutrition and care, as well as adequate water and sanitation."

- d) During 2012, 14.5% of U.S. households were considered to be food insecure at some time during the year. This means that these households “. . . had difficulty at some time during the year providing enough food for all their members due to a lack of resources.” Slightly over one-third of these people (5.7%) have very low food security. This means that “. . . at times during the year, the food intake of household members was reduced and their normal eating patterns were disrupted because the household lacked money and other resources for food” (Coleman-Jensen et al 2013, p. 5).
 - e) The percentage of food insecure households in the U.S. fluctuated between 10.1% and 11.9% between 1998 and 2007. After 2008 it rose above 14.5%, where it has stayed since.
 - f) Part of the reason for the increase in food insecurity starting in 2008 is the extreme rise in food prices during that time. During the food crisis in 2008, food prices rose significantly for some crops, such as rice and wheat (75% and 120% respectively). Globally, average food prices rose over 50%.
 - g) Food insecurity was higher for households living below the poverty line (40.9%), with children (20.0%), and headed by a single parent (35.4% for women and 23.6% for men). Food insecurity was also higher for Black and Hispanic households (24.6% and 23.3%).
 - h) A primary cause of food insecurity is poverty (Johns Hopkins Center for a Livable Future 2010)
 - i) One factor contributing to food insecurity is food deserts (Allen and Melcarek 2013; Agricultural Marketing Service, no date; Schafft, K., E. Jensen, and C. Hinrichs 2009)
 - i. Many low-income areas are considered food deserts. Food deserts are described as “. . . urban neighborhoods and rural towns without ready access to fresh, healthy, and affordable food,” (Agricultural Marketing Service, no date). These areas have no grocery stores. They may have no access to food, or only have access to fast food or convenience stores. Thus, the immediately accessible food is less healthy and/or more expensive.
 - ii. Food deserts are also more common in low-income neighborhoods that are predominantly people of color
 - iii. Food deserts, and food insecurity, appear to be related to health problems, e.g., research has found a relationship between food deserts and obesity and diabetes.
2. Obesity (Schoonover and Muller 2006)
- a) Extent of obesity: 2/3 of people in the U.S. are overweight and 1/3 are obese. The rates of obesity among youth have doubled and even tripled for different age groups since the 1970s
 - b) Obesity is associated with many health effects, such as diabetes, heart disease, some cancers, and more.
 - c) The causes of obesity are complex (see on-line interactive diagram at: www.shiftn.com/obesity/Full-Map.html)
 - d) However, the current food system contributes several factors:
 - i. Lack of access to healthy foods, which exists in food deserts, as well as easier access to less nutritious foods, are important components
 - ii. Farm bill policies affect food prices
 - U.S. Farm Bill policies make commodities (corn and soy) much cheaper than fruits and vegetables
 - These commodities are used to make less healthy processed foods, and inexpensive sweeteners and oils. This makes less healthy food less expensive, and therefore more economical than healthier foods. For example, at McDonalds, it is more economical to buy a hamburger (partially due to cheap price of corn used to produce beef) than a salad.

- Due to economic constraints, many do not have to the capacity to buy fresh, healthier foods. Even for those that do have a choice, consumer research has found price to be a strong determining factor in what people purchase. One study found that lowering the price of healthier snacks in a vending machine encourages people to buy more of them. But when the prices returned to normal, they chose the less healthy snacks.
3. Antibiotic resistance (Center for Disease Control 2013; Pew Commission on Industrial Farm Animal Production 2009)
 - a) Industrial farming is contributing to antibiotic resistance
 - i. Many bacteria are becoming resistant to antibiotics. Antibiotic overuse is the main reason, and thus minimizing unnecessary use is critical. The two unnecessary uses are the over-prescription of antibiotics to humans, and the unnecessary use of antibiotics in animals. Currently CAFO operations use low levels of antibiotics regularly in animals as such a use has been found improve growth rates. It is estimated that up to 70% of the antibiotics used are for farm animals.
 - ii. As antibiotics become ineffective, many more people will become sick, and many will die, from simple infections
 4. Impact of agricultural chemicals (Pesticide Action Network, no date)
 - a) Agricultural pesticides increase risks of a number of diseases, such as cancer, asthma, autoimmune diseases, and others
 - b) Over 90% of Americans have tested positive for having pesticide metabolites in their blood, such as from DDT and chlorpyrifos (a neurotoxic insecticide)
 - c) Those who work on farms, their families, and the broader rural community are most affected by these chemicals
 5. Living in agricultural communities
 - a) Pesticide drift/exposure
 - b) CAFO impacts (Pew Commission on Industrial farm Animal Production 2009)
 - i. Ground water contamination can affect the drinking water supply for a large area. Infectious agents, such as flu virus, can affect the community as well as spread through the meat processing chain.
 - ii. Food-borne infections are more likely to happen due to the number of animals concentrated in one space
 - iii. Increased asthma risk and problems with odor from the facilities are other frequently cited issues

Discussion Questions

SOCIAL ISSUES IN CURRENT U.S. AGRICULTURE, LECTURES 1 & 2

1. Why do you think it is important to understand the social or human impacts of the food system?
2. What did you learn from these two lectures that was surprising to you? Why was it surprising? What did you previously assume to be true?
3. What are some of the most concerning issues raised? Why?
4. Are there any topics from these lectures that you are interested in learning more about? Why? How will you go about learning it?
5. How does learning about this material impact how you intend to participate with the food system (as a farmer, activist, consumer, etc.)?

References & Resources

SUGGESTED READINGS (DESCRIBED BELOW)

LABOR

- Schlosser, 2001, chapters 7 and 8
- Rothenberg, 1998
- Steinbeck, 1939

CONCENTRATION

- Hauter, 2012

HEALTH

- Freinkel, 2014
- Allen and Melcarek, 2013

LABOR REFERENCES/RESOURCES

Ahn, Christine, Melissa Moore, and Nick Parker. 2004. *Migrant Farmworkers: America's New Plantation Workers*. Food First Backgrounder, Vol 10, No 2. March 2004. www.foodfirst.org/fr/node/45

Good short summary of issues, particularly regarding immigration and free trade policies.

Allen, Patricia, and Hilary Melcarek. 2013. *The Human Face of Sustainable Food Systems: Adding People to the Environmental Agenda*. Sustainability in the Balance Series. Center for Agroecology & Sustainable Food Systems. Santa Cruz, CA. casfs.ucsc.edu/documents/issue-papers/sust_in_balance_5.pdf

This document summarizes recent data related to injustice in the food system. It provides statistics on health and labor issues, as well as summarizing efforts attempting to address these disparities.

Bauer, Mary, and Mónica Ramírez. 2010. *Injustice on Our Plates: Immigrant Women in the U.S. Food Industry*. Southern Poverty Law Center. www.splcenter.org/sites/default/files/downloads/publication/Injustice_on_Our_Plates.pdf

This report documents the lives of 150 immigrant women from Mexico and Central America who work in the fields and food processing factories in the U.S. It depicts the brutality of their situation, and concludes by

calling for legislation in different arenas to end the exploitation these workers frequently face.

Carrasquillo, Nelson. 2011. Race and ethnicity from the point of view of farm workers in the food system. Farmer workers in the food system. *Race/Ethnicity* Vol. 5. No.1. www.cata-farmworkers.org/Nelson%20Article.pdf

This article offers a brief history of farm work in the U.S., with a specific East Coast perspective.

Farmworker Justice. 2012. *Health Reform and Farmworkers*. Farmworkerjustice.org. www.farmworkerjustice.org/sites/default/files/documents/Health%20Reform%20and%20Farmworkers.pdf

Freinkel, Susan. 2014. Warning signs: How pesticides harm the young brain. *The Nation*. March 11. www.thenation.com/article/178804/warning-signs-how-pesticides-harm-young-brain#

This article summarizes new research on neurological effects of pesticides, particularly on the the children of farm workers.

Jayaraman, Saru. 2013. *Behind the Kitchen Door*. Ithaca, NY: Cornell University Press.

An excellent book about the food service industry. The author unveils the extent to which food service workers live below the poverty line, endure illegal treatment (withholding of wages and overtime pay), and endure race and gender discrimination. She also points out how even restaurants focused on qualities of the food movement, such as promoting local and sustainable, don't necessarily treat their employees well or even fairly. She also points to the many reasons why it matters, from human rights and dignity to the simple correlation in research that restaurants that don't treat their workers well are more likely to have health-related food practice violations. Very engaging to read. Stories can be useful for class discussions. She also provides potential solutions, with her primary goal to improve the lives of those working in the food service industry.

Kandel, William. 2008. *Profile of Hired Farmworkers: A 2008 Update*. Economic Research Report No. 60, Economic Research Service, U.S. Department of Agriculture. www.ers.usda.gov/media/205619/err60_1_.pdf

Lopez, Ann A. 2007. *The Farmworkers' Journey*. Berkeley: University of California Press..

This book explores the lives and situation of migrant farmworkers who routinely travel between west-central Mexico and central California to make a living. Ten years of conducting ethnographic research in California and Mexico led to the production of this book. Depictions of the lives of farmworkers, and subsistence farmers in Mexico, are presented along with the structural policies, institutions, and context that keep these people in perpetual poverty and this particular way of life.

McWilliams, Carey. 1935. *Factories in the Fields: The Story of Migratory Farm Labor in California*. Berkeley, CA: University of California Press.

Excellent and critical historical analysis of farm labor in California. Special emphasis is placed on the ways in which ethnicity and the seasonality of labor demand combine with industrial capitalism's infiltration of agriculture to create an unjust labor system.

The National Commission on Agricultural Trade and Export Policy. 1986. *New Realities: Toward a Program of Effective Competition*. Washington D.C.: U.S. Department of Agriculture.

Pollan, Michael. 2002. Power Steer. *New York Times Magazine*. 3/31/02. www.nytimes.com/2002/03/31/magazine/power-steer.html?pagewanted=all&src=pm

Enlightening investigative article navigating the U.S. beef industry.

Rothenberg, Daniel. 1998. *With These Hands: The Hidden World of Migrant Farmworkers Today*. New York: Harcourt Brace and Company.

This book describes the lives of farmworkers and the system within which they work. Interviews with farmworkers, contractors, farmers, and others in this area and presented in their words. Background research and the author's conclusions are also included. This wide variety of interviews gives the reader an education on the power relations and structure of employment in U.S. agriculture, as well as a

fair treatment of a very wide set of perspectives and first-person testimonies of the difficult racial, class, and citizenship problems associated with migrant labor.

Schlosser, Eric. 2001. *Fast Food Nation: The Dark Side of the All-American Meal*. New York: Houghton Mifflin Company.

*This book focuses on all the components behind the production of fast food. Three chapters focus on labor issues. Chapter 3 looks at food service labor in the fast food restaurant. Chapter 7—*Cogs in the Machine*—give a brief history of the current meat packing industry, showing how it got to where it is today. Chapter 8 details what it is like working in the new meatpacking plants.*

Schlosser, Eric. 2003. In *the Strawberry Fields, in Reefer Madness: Sex, Drugs, and Cheap Labor in the American Black Market*. New York: Houghton Mifflin Company.

Steinbeck, John. 1939. *The Grapes of Wrath*. New York: Viking Penguin Books.

At minimum, the first twelve chapters are recommended for their poignant and compelling discussion of the human and environmental impacts of agricultural modernization. The parallels between the experiences of the characters in this novel and today's migrant laborers should not be overlooked.

Thompson Jr., Charles D., and Melinda F. Wiggin eds. 2002. *The Human Cost of Food: Farmworkers' Lives, Labor, and Advocacy*. Austin, TX: University of Texas Press.

This edited book covers several topics related to farm labor, such as health, housing and immigration issues. Other chapters explore the how farmworkers are excluded from labor laws, history of the guest worker program, challenges facing migrant students, and the history of labor organizing. Includes an outline for developing a syllabus for a more extensive education, aimed at farmworker advocacy.

U.S. Department of Labor. 2012. Occupational Employment Statistics—May 2012 National Occupational Employment and Wage Estimates in the United States. Bureau of Labor Statistics. www.bls.gov/oes/current/oes_nat.htm#35-0000

U.S. Department of Labor. 2014. *Minimum Wages for Tipped Employees*. Wage and Hour Division. January 1, 2014. www.dol.gov/whd/state/tipped.htm#foot1

U.S. Department of Labor. No Date. *elaws—Fair Labor Standards Act Advisor*. Office of the Assistant Secretary for Policy. www.dol.gov/elaws/esa/flsa/screen75.asp

U.S. Department of Labor. No Date:a. *The National Agricultural Workers Survey*. Employment and Training Administration. www.doleta.gov/agworker/report9/chapter1.cfm

VanDeCruze, Denise, and Melinda Wiggins. 2008. *Poverty and Injustice in the Food System: Report for Oxfam America*. Student Action with Farmworkers. Durham, NC. ducis.jhfc.duke.edu/wp-content/uploads/2010/06/Poverty-and-Injustice-in-the-Food-System.pdf

This paper summarizes the situation of farm workers and food processing workers in the Southeastern U.S. It documents the current situation and demographics, explores the history of food workers, and discusses solutions to the particular issues in this region of the country.

Wadsworth, Gail. 2014. What Does Food Justice Mean for Farmworkers? *Food First Blog post*. January 14, 2014. www.foodfirst.org/en/What+Does+Food+Justice+Mean+for+Farmworkers%3F

Yen Liu, Y. and D. Apollon. 2011. *The Color of Food*. Applied Research Center. February 2011. www.foodfirst.org/en/node/3305

This report graphically displays statistics about food system workers throughout the supply chain. It is an excellent resource, available for free on the web.

CONCENTRATION REFERENCES/RESOURCES

Ashenfelter, Orley, and Daniel Hosken. 2008. *The Effect of Mergers on Consumer Prices: Evidence from Five Selected Case Studies*. National Bureau of Economic Research Working Paper Series, Working Paper 13859. Cambridge, MA. <http://www.nber.org/papers/w13859>

Dimitri, Carol, Ababayehu Tegene, and Philip Kaufman. 2003. *U.S. Fresh Produce Markets: Marketing Channels, Trade Practices, and Retail Pricing Behavior*. ERS Research Brief. AER-825.

Economic Research Service. U.S. Department of Agriculture. September 2003. www.ers.usda.gov/publications/aer-agricultural-economic-report/aer825.aspx#.UwviQF6V8pc

Freese, Bill, and George Kimbrell. 2013. *Seed Giants vs. U.S. Farmers*. Center for Food Safety and Save Our Seeds. www.centerforfoodsafety.org/files/seed-giants_final_04424.pdf

Hauter, Wenonah. 2012. *Foodopoly: The Battle over the Future of Food and Farming in America*. New York, NY: The New Press.

This book looks at issues around concentration and monopoly in the food system. Hauter's main thesis is that we cannot change the food system simply by voting with our pocketbooks, but that we must address the concentration, deregulation and corporate control in the biological sciences (seed) and processing/distribution realms.

Heffernan, William. D. 1998. Agriculture and monopoly capital. *Monthly Review* 50: 46 (July/August).

Loba, Linda, and Katherine Meyer. 2001. The great agricultural transition: Crisis, change and social consequences of twentieth century U.S. farming. *Annual Review of Sociology*, 27:103-124.

Lynn, B., and P. Longman. 2010. Who broke America's jobs machine: Why creeping consolidation is crushing American livelihoods. *Washington Monthly*. March 4. www.washingtonmonthly.com/features/2010/1003.lynn-longman.html

Lyson, Thomas A., and Annalisa Lewis Raymer. 2000. Stalking the wily multinational: Power and control in the U.S. food system. *Agriculture and Human Values* 17: 199-208.

Discusses multinational corporation's newfound control over the U.S. food system; the degree of concentration of control within the leadership of these firms; and the implications of this consolidation for growers, workers, and consumers.

Mitchell, Stacy. 2011. Eaters, beware: Walmart is taking over the food system. *Grist*. December 30, 2011. grist.org/food/2011-12-30-eaters-beware-walmart-is-taking-over-our-food-system/

Pew Commission on Industrial Farm Animal Production. 2009. *Putting Meat on the Table: Industrial Farm Animal Production in America*. A Project of The Pew Charitable Trusts and Johns Hopkins Bloomberg School of Public Health. www.ncifap.org/_images/PCIFAPFin.pdf

This document provides an excellent overview of the broad issues and problems stemming from large-scale animal production. It reviews how the current situation developed, public health issues, environmental impacts, animal welfare issues, effects on rural residents, and suggested solutions.

U.S. Department of Justice. 2012. *Competition and Agriculture: Voices from the Workshops on Agriculture and Antitrust Enforcement in Our 21st Century Economy and Thoughts on the Way Forward*. www.justice.gov/atr/public/reports/283291.pdf

U.S. Department of Agriculture. 2012. *Table 2: Market Value of Agricultural Products Sold Including Landlord's Share and Direct Sales: 2012 and 2007*. Census of Agriculture. www.agcensus.usda.gov/Publications/2012/Full_Report/Volume_1,_Chapter_1_US/st99_1_002_002.pdf

U.S. Department of Agriculture. 2007. *Table 2: Market Value of Agricultural Products Sold Including Landlord's Share and Direct Sales: 2007 and 2002*. Census of Agriculture. www.agcensus.usda.gov/Publications/2007/Full_Report/Volume_1,_Chapter_1_US/st99_1_002_002.pdf

HEALTH REFERENCES/RESOURCES

Agricultural Marketing Service. No Date. *Food Deserts*. United States Department of Agriculture. apps.ams.usda.gov/fooddeserts/foodDeserts.aspx

Allen, Patricia, and Hilary Melcarek. 2013. *The Human Face of Sustainable Food Systems: Adding People to the Environmental Agenda*. Sustainability in the Balance Series. Center for Agroecology & Sustainable Food Systems. Santa Cruz, CA. casfs.ucsc.edu/documents/issue-papers/sust_in_balance_5.pdf

This document summarizes recent data related to injustice in the food system. It provides statistics on health and labor issues, as well as summarizing efforts attempting to address these disparities.

Center for Disease Control and Prevention. 2013. *Antibiotic Resistance Threats in the United States: 2013*. U.S. Department of Health and Human Services. www.cdc.gov/drugresistance/threat-report-2013/pdf/ar-threats-2013-508.pdf

Coleman-Jensen, A., M. Nord, and A. Singh. 2013. *Household Food Security in the United States in 2012*. Economic Research Report Number 155, Economic Research Service, United States Department of Agriculture. www.ers.usda.gov/publications/err-economic-research-report/err155.aspx#.Uwu0w-F6V8pd

Food and Agriculture Organization of the United Nations. No Date. *Hunger Portal*. www.fao.org/hunger/en/

This interactive website give statistics on hunger world-wide, by country and year.

Freinkel, Susan. 2014. Warning signs: How pesticides harm the young brain. *The Nation*. March 11. www.thenation.com/article/178804/warning-signs-how-pesticides-harm-young-brain#

This article summarizes new research on neurological effects of pesticides, particularly on the children of farm workers.

Johns Hopkins Center for a Livable Future. 2010. *Hunger and Food Security: Background Reading*. From *Teaching the Food System Curriculum*. www.jhsph.edu/research/centers-and-institutes/teaching-the-food-system/curriculum/_pdf/Hunger_and_Food_Security-Background.pdf

This 6-page document provides a useful introduction to hunger and food security. It is intended as an overview for students.

Perkins, Tracy. 2009. 25 Stories from the Central Valley. twentyfive.ucdavis.edu/exhibit.aspx

This online photo exhibit documents the health impacts from agriculture pesticides and pollution on the primarily of color and poor residents of California's central valley, as well as actions of the women activists working for environmental justice.

Pesticide Action Network. No Date. www.panna.org

This is a useful website for information on pesticides, including their impacts on health and the environment.

Pew Commission on Industrial Farm Animal Production. 2009. *Putting Meat on the Table: Industrial Farm Animal Production in America*. A Project of The Pew Charitable Trusts and Johns Hopkins Bloomberg School of Public Health. www.ncifap.org/_images/PCIFAPFin.pdf

This document provides an excellent overview of the broad issues and problems stemming from large scale animal production. It reviews how the current situation developed, public health issues, environmental impacts, animal welfare issues, effects on rural residents and suggested solutions.

Rosset, Peter, Joseph Collins, and Francis Moore Lappé. 2000. Lessons from the Green Revolution: Do we need technology to end hunger? *Tikkun Magazine* 15(2) (March/April 2000): 52-56.

Good “Food First” connection of the issues of hunger, agricultural technology, ecology, income, and power.

Schafft, Kai A., Eric B. Jensen, and Clare Hinrichs. 2009. Food deserts and overweight school children: Evidence from Pennsylvania. *Rural Sociology* 74(2), pp. 153-177

Steingraber, Sandra. 2010. *Living Downstream: An Ecologist’s Personal Investigation of Cancer and the Environment*. Philadelphia, PA: Da Capo Press.

This well-written book explores the relationship of chemicals (agricultural and others) in our environment to cancer, through both the science and the author’s own story as a biologist and cancer survivor. An important and engaging effort.

Schoonover, Heather, and Mark Muller 2006. *Food without Thought: How U.S. Farm Policy Contributes to Obesity*. Instituted for Agriculture and Trade Policy. March 2006. www.iatp.org/files/421_2_80627.pdf

Troy, Lisa, Emily Ann Miller, and Steve Olson. 2011. *Hunger and Obesity: Understanding a Food Insecurity Paradigm* (workshop summary). Institute of Medicine of the National Academies. The National Academies Press. Washington D.C.

World Health Organization. No Date. *Trade, Foreign Policy, Diplomacy and Health: Food Security*. www.who.int/trade/glossary/story028/en/

OTHER RESOURCES

Alkon, Alison Hope, and Julian Agyeman, eds. 2011. *Cultivating Food Justice: Race, Class, and Sustainability*. Cambridge, MA: MIT Press.

This edited book offers a series of narratives exploring how race and class are intertwined in the food system. Its premise is that much of the food movement has come from white and middle-class people, who come from a shared perspective. This book intends to provide a broader critique of the industrialized food system, including injustice in the conversation.

Allen, Patricia. 2004. *Together at the Table: Sustainability and Sustenance in the American Agrifood System*. University Park, PA: Pennsylvania State Press.

Examines the growth and development of alternative food system initiatives in the U.S., including: The growth of organic farming and the development of the USDA National Organic Program; the growth in popularity of direct marketing relationships such as farmers’ markets and community-supported agriculture (CSA); the growth of urban agriculture and community garden programs; the increase in natural and social science research programs focused on sustainable food and farming systems.

Cunningham, Brent. 2010. Food fighter: Grist’s Tom Philpott on why class needs to be a part of the food debate. *Columbia Journalism Review*, 4 May. Online.

Friedland, William H. 1981. *Manufacturing Green Gold*. Cambridge, MA: Cambridge University Press.

A classic work describing how agricultural industry structure is related to the social relations of production and technological change.

Gottlieb, Robert, and Anupama Joshi. 2010. *Food Justice*. Cambridge, MA: MIT Press.

This book describes the myriad issues pertaining to food justice, such as farmworkers’ and meat processing workers’ conditions, food access issues, and over-processing of food. The book also describes the food justice movement that has arisen from these conditions. It tells the stories of groups and individuals working to make change, both in the U.S. and internationally.

Guthman, Julie. 2008. "If they only knew": Color blindness and universalism in California alternative food institutions. *The Professional Geographer* 60 (3):387-97.

Patel, Raj. 2007. *Stuffed and Starved*. Brooklyn, NY: Melville House Publishing.

Excellent book that provides an overview of the current food system and the results of the choices made by corporations, governments, farming communities, and others. Topics covered include farmer suicides, migration, trade agreements and development, agribusiness winnings, control of seed, and the example of soybeans—where all the factors described come together. Also includes a focus on the power of the supermarket industry and how people are constrained as consumers.

FILMS AND VIDEOS

A Place at the Table. 2012. Magnolia Pictures (84 minutes).

www.magpictures.com/aplaceatthetable/

This film explores the issue of hunger in the U.S. It follows three families as they grapple with food insecurity, and explores the reasons behind it. The film makes the point that we can do something to end it.

Food Stamped: Is It Possible to Eat Healthy on a Food Stamp Diet? 2011. By Shira and Yoav Potash. Summit Pictures (62 minutes).

www.foodstamped.com

This documentary chronicles a couple as they attempt to live in a healthy manner on a food stamp budget. During this experiment, they also consult with others in the food system: those on food stamps, congress members, nutrition experts, etc.

Forgotten Voices: The Story of the Bracero Program. No Date.

www.youtube.com/watch?v=AL5d9CWW0Xg

This 7-minute video provides an excellent overview of one group of immigrants' experience, under one policy program. It provides a very descriptive look at the lives of these workers, including the abuses and reasons for those participating, in the program.

The Harvest / La Cosecha: The Story of Children Who Feed America. 2011. (80 minutes).

theharvestfilm.com

This film documents child labor in U.S. agriculture.

Slavery and the Making of America. 2004. Thirteen/WNET New York.

www.pbs.org/wnet/slavery/index.html

This multipart series includes the history of slavery and agriculture. This website contains interactive features. Check Youtube for video episodes.

Soul Food Junkies. 2012.

www.pbs.org/independentlens/soul-food-junkies

In a quest to understand why his father is unwilling to change his traditional soul food diet while dealing with a serious health issue, the filmmaker ". . . sets out to learn more about this rich culinary tradition and its relevance to black cultural identity." He explores the issues through conversations with a variety of people in the food system, and identifies socio-economic issues that play a large role. He also explores solutions by speaking with those in the food justice movement making those changes happen, including making healthier versions of soul food.

CURRICULUM RESOURCES: SEE UNIT 3.1, RESOURCES

Environmental Issues in Modern Agriculture

Introduction	55
Lecture 1: Technical Innovations	57
Lecture 2: Alternatives to Conventional Agriculture	65
Discussion Questions, Lectures 1 and 2	67
References and Resources	68

Introduction: Environmental Issues in Modern Agriculture

OVERVIEW

This unit introduces students to the most common agricultural practices employed in conventional production, and the major agricultural, environmental, and human health concerns that have arisen as a result of their use over the last century.

Two lectures cover the socioeconomic factors that shape conventional modern agricultural production; key elements of modern agriculture and their environmental and human health impacts; and critical interactions between natural and agroecosystems. The lectures also present the set of alternative farming practices that have been used to avoid risks to environmental quality and human health. The lectures conclude with a discussion of the policy, regulatory, and economic factors that reinforce the conventional agriculture model and the policy and economic changes that need to take place in order to develop more sustainable production systems.

Note: It is important to convey to students that many “conventional” farming operations, though not operating under National Organic Program organic certification, often integrate many of the “sustainable agriculture” practices outlined in this manual. Further, it is important to discuss that mere adherence to the minimum requirements of organic certification does not necessarily constitute sound agricultural practices. Students should understand that agriculture itself (whether “certified organic” or “conventional”) is one of the most extensive and environmentally disruptive land use practices that human beings currently employ. Additionally, it is important to stress that it is often market pressures and the need to maintain a competitive advantage/economic viability that have encouraged individual farmers to adopt agricultural technologies that have later proven to have negative environmental or human health consequences. Lastly, though environmental degradation often results from the simple misuse or over-application of agricultural technologies (e.g., synthetic N-P-K fertilizers), certain agricultural technologies (e.g., GMOs and pesticides) currently pose either an unknown or well-substantiated environmental quality and/or human health risk.

MODES OF INSTRUCTION

> LECTURES (2 LECTURES, 50 MINUTES EACH)

Lecture 1 reviews a framework of analysis to understand the factors driving change in modern agricultural systems—technology and capital—and an explanation of how changes in production have impacted environmental and human health.

Lecture 2 includes an overview of alternative agricultural practices and concludes with an examination of the necessary policy and economic changes needed for their widespread adoption.

References given in the outlines are described in the References and Resources section.

LEARNING OBJECTIVES

CONCEPTS

- The environmental impacts of modern agriculture are the consequence of the paths of technological development taken in this country
- The “technology treadmill”: The technological package of modern agriculture as a system with its own internal logic, fueled and maintained by the techno-scientific and socioeconomic systems in which it is situated
- The development of agricultural mechanization, agricultural chemicals, and agricultural biotechnology and their impact
- The major environmental impacts and human health risks of modern agriculture: Water, soil, and air, biological diversity, and human health
- The barriers to adoption of conservation measures that would reduce these risks
- The set of organic/sustainable farming practices that are used to avoid risks to environmental quality and human health
- The policy and economic changes that need to take place in order to develop more sustainable production systems

Lecture 1: Technological Innovations

A. The Shaping of Conventional Agriculture: Technological Innovations, Investment Capital, and the Technology Treadmill (see Cochrane 1993; FitzSimmons 1986; Heffernan et al. 1999)

1. The initial resistance of agriculture to the forces of capitalism
 - a) Crop production as high-risk investment: Capital investors initially reluctant to invest in agriculture with productivity and profit being tied to biological processes and variables of natural environment
2. New agricultural technologies and capitalist investment
 - a) As new agricultural technologies were developed and introduced into agriculture, capitalist investors found it more profitable to invest in the technologies rather than crop production itself
 - b) Consequences
 - i. Farmers become dependent upon constantly evolving inputs of agricultural technology
 - ii. Agricultural technologies require substantial financial investment, thus requiring many farmers to obtain loans to reinvest in technology
 - iii. Capital investors and technology manufacturers control agricultural technology
 - iv. The restructuring of farm economics: New technology requires access to capital (loans, credit) for investment. This favors larger, well-capitalized farmers or farming corporations and puts smaller farmers at a competitive disadvantage, who often have to sell out, contributing to the growth in farm size and the loss of more small farms.
3. "The technology treadmill"
 - a) The technology treadmill defined: The self-reinforcing cycle of technological dependency, driven by the application of technology and investment capital to agriculture
 - i. Competition in the marketplace encourages the adoption of new agricultural technologies that allow for increases in efficiency or increases in the scale of production
 - ii. Increased efficiency, increases in the scale of production convey a competitive advantage through the economies of scale
 - iii. Crop prices are driven down because of efficiencies in production and the reduced costs per unit produced
 - iv. This drives some small producers out of business because they cannot access the credit needed to invest in the latest technology that is now essential in competing in the market place
 - v. Concurrently, this encourages producers to further increase the scale of production to have the size of operations necessary to cover their debts incurred through purchases of technology inputs
 - vi. The agricultural technologies used in expanding the scale of production have had significant social and environmental consequences

B. Technological Innovations and Practices Used in Conventional Agriculture

1. Fossil fuel use in conventional agriculture
 - a) Fossil fuel was first used on the farm to replace human labor and animal power. It was a great labor-saving device. It laid the foundation for monocultural production (through tractors) and long distance shipping of agricultural products.
 - b) The influence of fossil fuel
 - i. Economically subsidized in many ways: Highways; lower prices for larger volumes of fuel used; externalized environmental costs (e.g., CO₂, oil spills, etc.)
 - ii. Inexpensive fossil fuel power makes long-distance, cross-country, and international transportation of food and fiber cost effective. Cost effectiveness of international import agriculture is further assured by lower costs of production in developing nations due to lower environmental and social justice standards.
 - iii. Local and sustainable food systems cannot compete against large-scale agriculture with economically efficient long-distance food transport and the suite of externalized costs
2. Monoculture cropping systems (see Kimbrell 2002)
 - a) Monoculture defined: The planting of genetically similar or uniform crop varieties over large tracts of land, sometimes without rotation to other crops in space or time
 - b) Scale of monocultures: Monocultures can occupy hundreds to thousands of acres of land
 - c) Known and potential agroecological risks:
 - i. Agriculture as environmental degradation: With 600 million hectares worldwide, and 943,000 acres of arable land under cultivation in the U.S., it is the most extensive terrestrial-based activity
 - ii. Agriculture has resulted in the conversion and degradation of grassland, woodland, and wetland ecosystems in the U.S. and around the world
 - iii. Highly simplified agricultural ecosystems maintain large carrying capacity for “pest” organisms and low carrying capacity for natural predators of agricultural pests
 - iv. Narrow and therefore vulnerable crop gene-pool
 - v. Dependency on biocides to control pests
 - vi. Soil loss and siltation of waterways through wind and water erosion in the absence of cover crops
 - vii. Uninterrupted pest/host relationship resulting in buildup of pest and pathogen populations
3. Hybrid seed (see Kloppenburg 2004)
 - a) History of seed production: Historically, farmers selected seed from the crop plants that produced well in a given area. This assured a locally adapted crop gene pool.
 - b) Though rapidly changing, this is still the practice in most of the world today
 - c) The development of off-farm selective breeding programs
 - i. Geneticists began controlled breeding of corn varieties in the first half of the 20th century to improve yields
 - ii. Hybrid seed varieties—a product of a forced cross between homogeneous inbred lines—have superior traits, such as uniformity in growth and yield, uniform ripening, better taste, consistent germination, and processing and shipping qualities
 - iii. Traits in hybrid seeds can only be assured during the first generation, requiring farmers to buy hybrid seeds annually
 - iv. This created a huge economic opportunity for seed companies by generating input dependence by farmers on these high-yielding seeds

- v. It also meant that entire counties or states could have near-uniform and therefore vulnerable crop genetics
- d) The adoption of hybrid seed
 - i. Government agencies and seed companies conducted extensive campaigns to “modernize” farmers by persuading them to buy “improved” seeds
 - ii. Farmers who were resistant, either because they suspected efforts to make them buy off-farm inputs, or because they simply saw no reason to change, were ridiculed
 - iii. As early adopters began to profit from improved seeds, they were able to outcompete their neighbors
 - iv. Early adopters of agricultural technologies began to buy their neighbors out, encouraging the concentration of ownership
- e) Known and potential agroecological risks
 - i. The loss of genetic diversity of crop plants
 - ii. They may lack traits that have other ecological functions, such as disease resistance
 - iii. Narrow genetic base and therefore vulnerable to pests and pathogens
 - iv. Dependency on pesticide use
 - v. Loss of biodiversity of sexually reproduced crop plants
 - vi. Input dependence by farmers
- 4. GE: Genetically Engineered organisms (see Gurian-Sherman 2009; www.centerforfoodsafety.org; Kimbrell 2002)
 - a) What are genetically engineered (GE) organisms?

Genetic engineering (GE) is the transfer of genes from one organism to another through means that do not occur without human intervention. This involves isolating and then moving genes within and without different species by recombinant DNA techniques and other manipulation of the genetic construct outside the traditional practices such as sexual and asexual breeding, hybridization, fermentation, in-vitro fertilization and tissue culture.
 - b) Examples of GE technologies
 - i. Bt-producing crops, herbicide-resistant crops, vitamin-producing crops, pharmaceutical crops, GE animals (e.g., salmon)
 - ii. Terminator seeds: Despite the moratorium since 2001, there is increasing pressure to use them. (Watts and Vidal 2013).
 - c) Claims about benefits of GE crops
 - i. Feeding the world: However, malnutrition and hunger are largely problems of maldistribution of food and poverty, not of underproduction
 - ii. Reducing pesticide use: Bt crops appear to be reducing the use of pesticides. However, increasing insect resistant to Bt is a concern. In contrast, herbicide use has increased as GE crop plants have higher tolerances for herbicides (Benbrook 2012).
 - iii. Increasing yield: A recent Union of Concerned Scientists report states that looking at studies for the past 20 years, there has been little increase in yield from GE crops. They suggest overall yield increases in corn are based on non-genetic engineering approaches (Gurian-Sherman 2009).
 - iv. Other claims: Herbicide-resistant crops require less work, allowing farmers more time. However it puts farmers on the technological treadmill, having to pay more for input solutions to problems instead of managing problems by working within natural systems.
 - d) Worldwide increase in the use of GE technology
 - i. Herbicide-resistant crops (HRCs) and insect-resistant crops (Bt crops) accounted for 59 and 15 percent respectively of the total global area of all transgenic crops in 2000

- ii. Worldwide, transgenic crops increased at a rate of 6% per year, for the past 17 years. As of 2012, there were 170.3 million hectares in biotech crops (International Service for the Acquisition of Agri-Biotech Applications 2012).
 - iii. The U.S., Brazil, Argentina, and Canada, had the most acreage in GE crops in 2012. The most commonly grown crops worldwide are herbicide-tolerant soybeans (47% of biotech), stacked traits maize (23%) and Bt cotton (11%) (International Service for the Acquisition of Agri-Biotech Applications 2012).
- e) Known and potential agroecological and human health risks
- i. Potential human allergens: Viral vectors and antibiotic markers are used to verify successful trans-genetic engineering
 - ii. Potentially unknown viruses, toxins, and pathogens could be created by vector-mediated horizontal gene transfer and recombination
 - iii. The “escape” of trans-genetic genes via wind and insect pollination to wild plant weeds of the same species resulting in irreversible genetic pollution
 - iv. Additional farmer dependency on technological inputs
 - v. Ethical questions around intellectual property rights of germplasm
 - vi. Loss of genetic diversity of crop plants through the abandonment of regional selection of sexually reproduced seed
 - vii. Loss of effectiveness through rapid evolution of resistance of biocontrol pesticides for organic systems: Example, Bt corn
 - viii. Transfer of genes/contamination of non-GMO and certified organic crops
 - ix. Reduction of the fitness of non-target organisms through the acquisition of transgenic traits via hybridization
 - x. The rapid evolution of resistance of insect pests such as to Bt
 - xi. Soil accumulation of the insecticidal Bt toxin
 - xii. Disruption of natural control of insect pests through intertrophic-level effects of the Bt toxin on natural enemies of agricultural pests
 - xiii. Unanticipated effects on non-target herbivorous insects (e.g., monarch butterflies) through deposition of transgenic pollen on foliage of surrounding wild vegetation
- f) GMOs as a crisis of democracy
- i. FDA has made the regulatory determination that they are “substantially equivalent” to non-GMO foods and that minimal testing needs to be done, and they need not be labeled. Simultaneously, industry has pursued patent rights for GMOs, which require novelty.
 - ii. GMOs sold and in widespread use before long-term studies on ecological and human health risks were conducted
 - iii. Question: Do individuals have the right to be informed of the potential environmental quality and human health risks associated with GMO as with other products (e.g., tobacco, alcohol, gasoline)?
5. Synthetic pesticides: herbicides, insecticides, rodenticides, and fungicides (see Benbrook 1996; Kegley 1999, 2000; Reeves 1999; Kimbrell 2002)
- a) Pesticides as “biocides”: A pesticide is any substance or mixture of substances used to destroy, suppress, or alter the life cycle of any target organism. A pesticide can be a naturally derived or synthetically produced substance. Pesticides are not able to discriminate between target and non-target organisms with similar physiology.
 - b) Origins of synthetic biocides: Developed in WWI and WWII as warfare agents and later applied to agriculture
 - c) How pesticides work: The physiology of biocides (see www.epa.nsw.gov.au/)

- i. Physical toxicity pesticides: Block the cellular processes of target organisms in a purely mechanical way. Examples include spray oils that clog the respiratory mechanism of insects.
 - ii Metabolic system inhibitors: There are many inhibitory pesticides in this category, such as rotenone and cyanide, that disrupt respiratory functions in animals; herbicides that inhibit seed germination or plant growth (especially at the root and shoot tips); and fungicides that inhibit germination of spores
 - iii. Protein synthesis and enzyme disruption: Proteins such as enzymes control many important cell functions. Many pesticides aim to disrupt enzyme processes or denature proteins. Examples include inorganic copper compounds, dithiocarbamate fungicides, phosphono amino acid herbicides such as glyphosate, and organophosphate insecticides.
 - iv. Hormonal system interference: Several pesticides simulate or otherwise interfere with hormones to disrupt hormone cycles. Examples are the phenoxy herbicides that interfere with plant growth hormones and insect growth regulators that interfere with cuticle formation in insects during molting.
 - v. Nervous system disruptors: These pesticides affect mainly animal groups such as insects, nematodes, and rodents. Some are narcotics such as some fumigant pesticides. Others disrupt the movement of nerve impulses, such as the organophosphate, carbamate, and pyrethroid pesticides.
 - vi. Photosynthetic inhibitors: Pesticides that disrupt photosynthesis prevent the plant from producing or storing energy and ultimately kill the plant. Examples include the triazine, substituted urea, and uracil herbicides.
 - vii. Some pesticides work in more than one way and fall into more than one of these categories. The modes of action of many pesticides are not fully understood.
- d) Current trends in sales and use of biocides in agriculture (see Kegley 2000)
- i. California: ~160 million pounds of active ingredients/year ¹
 - ii. U.S.: 1,133 million pounds active ingredients were estimated to have been used in 2006 and 2007 ²
 - iii. Misleading terms: Active ingredients and “inert” ingredients. Pesticide formulation may contain 99% inert ingredients. Many inert ingredients have adverse health effects and may be active ingredients in other pesticide formulations.
- e) Known and potential environmental and human health risks (see Kegley 1999, 2000; Reeves 1999; Moyers 1993)
- i. Toxicity to non-target organisms, including natural enemies of agricultural pests
 - ii. Surface and groundwater pollution: Toxicity to aquatic wildlife and humans through drinking water
 - iii. Bio-accumulation in wildlife populations
 - iv. Effects on the physical environment (e.g., methyl bromide and ozone depletion)
 - v. Acute poisoning and occupational exposure of farmers and agricultural workers with known endocrine-disrupting compounds, known and suspected carcinogens, and nerve toxins. (3 million human pesticide poisonings, and 220,000 deaths attributed to pesticides worldwide/year.)

1 Californians for Pesticide Reform. 2010. Healthy children and green jobs: A platform for pesticide reform. San Francisco, CA. pesticidereform.org/downloads/CPR-Platform-Nov-2010.pdf

2 Grube, A, D. Donaldson, T. Kiely and L. Wu. 2011. Pesticides industry sales and usage: 2006 and 2007 market estimates. U.S. Environmental Protection Agency. www.epa.gov/opp00001/pestsales/07pestsales/market_estimates2007.pdf

- vi. Dietary exposure to endocrine-disrupting compounds, known and suspected carcinogens and nerve toxins
- vii. Potential synergistic effects of exposure to environmental toxins with similar mechanisms of toxicity
- viii. Soil degradation: Reduce biological activity and diversity
- ix. Developed resistance and resilience in pest populations
- x. Dietary exposure and the safety of existing tolerance levels
- xi. Pesticides disproportionately affect predaceous “beneficial organisms” over pests, creating resurgence in populations of pest organisms
- f) The “logic” of pesticide use and the externalization of costs
 - i. For every \$1 spent on pesticides there are \$3 to \$5 in return³
- g) Estimates on financial costs to mitigate environmental damage
 - i. In the U.S., environmental costs are estimated to be around \$10 billion, depending on assumptions (Pimentel 2005). These costs of production are not compensated for by the farmer or agrochemical company.
- h) Legislation restricting the use of biocides (see Benbrook 1996)
 - i. The Food Quality Protection Act of 1996 (see www.epa.gov/opppsp1/fqpa/)
 - ii. Shortcomings of the FQPA (see www.ecologic-ipm.com)
- 6. Synthetically compounded N-P-K fertilizers (see also Supplement 4, Nitrate Contamination of Groundwater, in Unit 1.5, Irrigation—Principles and Practices)
 - a) What is synthetically compounded fertilizer? Synthesizing ammonia from nitrogen and hydrogen gas involves submitting nitrogen and hydrogen to at least 3,000 pounds per square inch of pressure, in the presence of osmium as a catalyst. Industrially produced synthetic ammonia is the principal source of the commercially available, industrially produced nitrogen and is the principal starting point from which all of the different kinds of industrially produced, so-called nitrogen “fertilizers” are made.
 - b) Known and potential agroecological and human health risks (see; U.S. Geological Survey 2010 , and Gliessman 2007)
 - i. The overapplication of synthetic N, P, and K nutrients are the most extensive form of “nonpoint source” (runoff) water pollution in the U.S.
 - ii Trends in nitrogen concentrations have changed little between 1993 and 2003. In places where there are changes, they tend to show increases rather than decreases (U.S. Geological Survey 2010).
 - iii. The overapplication of N-P-K fertilizers has greatly altered the global N and P cycles with unknown consequences (Gliessman 2007)
 - iv. Surface water contamination: N-P-K contamination leads to growth of algae and other plants (this process is called eutrophication). The plants utilize available oxygen and block sunlight penetration, harming fish and other marine organisms. This leads to “dead zones,” e.g., in the Northern Gulf of Mexico (see Carpenter et al. 1998; Miller 2008; U.S. Geological Survey 2010).
 - v. Energy-intensive production: Nitrogen fertilizer requires large amounts of natural gas, both to contribute hydrogen to the nitrogen, but also adding heat manufacture it. Fertilizer prices tend to be in line with those of natural gas (see Miller 2008; Sawyer et al 2010).

3 United States Environmental Protection Agency. 2012. Agricultural Pesticides.www.epa.gov/oecaagct/ag101/croppesticideuse.html

- vi. Drinking water contamination: Nitrate poisoning. Elevated nitrate levels in drinking water wells are common in agricultural areas and have resulted in a rare infant disease called methemoglobinemia (“blue-baby syndrome”; see www.cdfa.ca.gov).
 - In rural agricultural areas, 20% of shallow wells have nitrate levels above the federal drinking water standard (U.S. Geological Survey 2010)
 - vii. Excess nitrogen in crops can lead to increased susceptibility to pests and pathogens and poor post-harvest handling (Young, 1999)
 - viii. Soil degradation: Increased loss of soil organic matter; decreased soil biological activity and diversity; reduced aggregation and aggregate stability and the decline in desirable physical properties; increased soil erosion by wind and water; reduced nutrient availability through biological activity; increase susceptibility to pests and pathogens; increased dependence on synthetic chemical fertilizers and pest control agents to maintain productivity (Magdoff 2000)
7. Concentrated Animal Feeding Operations (Gurian-Sherman 2008 and Pew Commission on Industrial Farm Animal Production 2009)
- a) The number and size of Confined Animal Feeding Operations (CAFOs) have increased
 - i. Hog operations went from over 500,000 in 1982 to 60,000 in 2006, with no decrease in production overall
 - ii. The average size of a CAFO in 2004 was 12,000 animals in the Southern U.S.
 - b) Large amounts of manure create concentration of nutrients, resulting in significant nutrient pollution of air, water, and groundwater (e.g., nitrate contamination and eutrophication of surface waters)
8. Agricultural water use (Reisner 1993)
- a) In the Western U.S., roughly 90% of water diversion and supply goes to agriculture (U.S. Department of Agriculture 2013)
 - b) There are about 75,000 dams nationwide, and about 1500 in California
 - c) Environmental consequences of dams and water diversion
 - i. Dams degrade aquatic and riparian ecosystems by altering natural river flows, preventing flood flows necessary for the maintenance of habitat and wetlands, disrupting natural water temperatures, and reducing water quality
 - ii. In California, dams block 90% of the anadromous fish habitat for Chinook salmon and steelhead trout (Patrick 2005)
 - d) Groundwater depletion (see water.usgs.gov/ogw/gwrp/stratdir/future.html)
 - i. The overdraft of groundwater is resulting in the depletion of underground aquifers, resulting in increased costs of harvest and eventual loss of the resource
 - ii. Groundwater depletion in coastal areas may result in saltwater intrusion and salt contamination of ground water
 - iii. Land subsidence: Land compaction and sinking due to water extraction can damage buildings and infrastructure, as well as permanently decreasing the storage capacity available
 - e) Salinity problems
 - i. Salinity results from the accumulation of salt in the soil, resulting from the use of irrigation in poorly drained soils
 - ii. High soil salinity may result in the interference of water uptake and circulation leading to moisture stress in crop plants
 - iii. More than half of irrigated agricultural lands in California are affected by elevated salinity (University of California Agricultural Issues Center 2009)

9. The environmental consequences of international trade liberalization policies (see Korten 2001)

International trade liberalization policies (e.g., NAFTA and GATT) allow capital investors and U.S. and European food corporations to secure profits through the production of agricultural products in less developed nations (LDN). Costs of production in LDNs are much lower due to LDNs having lower environmental quality and social justice standards. These inexpensive products with many associated externalized costs are imported to the U.S. and Europe and sold at very low prices at large retail outlets.

10. Summary: Conventional agriculture, soil degradation, and the technology treadmill (see Magdoff 2000)

Market competition and the absence of laws restricting the use of agrochemicals encourage the adoption of new agricultural technologies that allow for increases in the efficiency and scale of production (e.g., monocultures, pesticides, synthetic N-P-K fertilizers, hybrid and GMO seeds). Large-scale monocultures create a large carrying capacity for “pest” organisms and low carrying capacity for natural predators of agricultural pests by simplifying the agroecosystem and surrounding plant communities. This results in the population growth of pest organisms and the inability of natural predators of insect pests to effectively prevent pest outbreaks. Pesticides are therefore applied in an attempt to control pest populations.

Pesticides disproportionately affect predaceous natural enemies of insect pests, resulting in the resurgence of insect pest populations and the development of genetic resistance of pests to pesticides. Pesticides become less effective and the intensity of pesticide use increases. The overuse of synthetic nitrate fertilizer may result in excessive vegetative growth and poor post-harvest quality, both of which are highly susceptible to pests. Pesticides are therefore applied in an attempt to control pest organisms.

Synthetic N-P-K fertilizers do not replace the organic matter necessary to maintain the soil biological diversity and activity needed to maintain disease suppression and desirable physical properties of agricultural soils. The use of synthetic fertilizers and the absence of sound crop rotation and cover cropping may encourage soil erosion and compaction, reduce the water- and nutrient-holding capacities of soil, and result in poor growing conditions for crops, leading to an increased susceptibility to both pests and pathogens. Intensive use of fertilizers, new pesticides, and tillage are then required to maintain productivity of such systems. This often results in further soil degradation and the unintentional exposure of agriculture workers, wildlife, and the general public to elevated levels of pesticides and nitrates in food and groundwater.

Agriculture itself (whether “certified organic” or “conventional”) is one of the most extensive and environmentally disruptive land-use practices, where terrestrial plant and animal communities are converted to row crops and enormous amounts of water are diverted to supply needed irrigation water. Irrigation water has led to elevated salt levels, which may result in the interference of crop plants to access and regulate moisture. Water diverted from rivers has resulted in the degradation of these aquatic ecosystems through the erection of dams. Overdraft of underground aquifers for agricultural use has led to the depletion of this resource, and in coastal areas, to the intrusion of saltwater into agricultural wells.

GMO crops pose an unknown environmental and human health risk, reduce the diversity of crop genetics and, where adopted, create further input dependence for farmers. Hybrid seed reduces the diversity of crop genetics and creates further input dependence for farmers.

Lecture 2: Alternatives to Conventional Agriculture

A. Viable Alternatives to Conventional Agriculture: Sustainable and “Organic”

Agriculture Practices (see Pesticide Action Network of North America 2009; National Research Council 1989; Magdoff 2000; see also Part 1, Organic Farming and Gardening Skills and Practices)

1. Soil health management: Maintaining optimal soil chemical properties
 - a) Nutrient budgeting based on balancing nutrient inputs with outputs: Matching crop demand with nutrient contribution of inputs. This approach attempts to assure that nutrient needs are met without creating nutrient excesses and their associated problems (e.g., nutrient runoff, leaching/nonpoint source pollution, pest susceptibility, and poor post-harvest quality).
 - b) Practices
 - i. Cover crops: Non-market crops, some of which are used to fix atmospheric nitrogen and carbon; cycle nutrient inputs and sub-soil nutrients (e.g., N and P respectively); stimulate soil biological activity; prevent nutrient leaching
 - ii. Compost: Depending on compost feedstock, can be a source of N-P-K and micronutrients; stimulates soil biological activity necessary for nutrient release
 - iii. Naturally occurring soil amendments and fertilizers: Supplies nutrients
 - iv. Proper irrigation: Prevents leaching of mobile nutrients
2. Soil fertility management: Soil physical properties
 - a) Perennial cover crop rotation: Allows soil to remain undisturbed and aggregate formation to proceed
 - b) Properly timed and quantity of tillage: Prevents compaction of soil and unnecessary oxidation of soil organic matter (SOM)
 - c) Cover crops: Prevent soil erosion; stimulate soil biological activity; allow soil to rest and aggregate formation to proceed
 - d) Compost: Stimulates soil biological activity, diversity, and aggregate formation
 - e) Proper irrigation: Prevents soil erosion
3. Non-toxic pest management
 - a) Sound soil fertility management (see above)
 - b) Polycultures: Diversity of crop plants maintains more even carrying capacity for pests and beneficial insects
 - c) Biocontrol of pest organisms, e.g., using releases of predaceous, parasitic, and parasitoid insects to reduce pest populations
 - d) Farmscaping: Non-crop vegetation used to encourage habitat for beneficial organisms and/or encourage pests away from market crop (trap crop)
 - e) Cover crops: Rotating crops interrupts pest-host cycle and attracts natural enemies of agricultural pests; stimulates soil biological activity; allelopathic control of pests
 - f) Compost: Stimulates soil biological activity and diversity that encourage disease-suppressive qualities of soils
 - g) Mating disruption: Pheromone releases timed with mating periods
4. Open-pollinated seed varieties: Maintain viability of regionally adapted (i.e., disease resistant) crop cultivars

B. Making Agriculture Practices in the U.S. More Environmentally Sound

(see Youngberg et al. 1993; Lockeretz 1997; Hassanein 1999)

1. Recognize what has driven change in agriculture over the past century: A complex interaction of social forces that have different impacts under different ecological conditions
2. Second step: Recognize that the primary instruments of change have been investment capital and technological developments
 - a) Behind these instruments are a host of social structures that have influenced our relationship to food and food production: capitalist economics, national policies, changes in the agricultural workforce, reduction in food costs and increased availability of foods, changes in diet preferences, and attitudes toward the role of food in culture
3. To effect change, advocates will have to work intensively in particular areas but link up with others working on a broad range of reforms
4. Economics
 - a) Support of policy initiatives that encourage local economic development that allows social and environmental values to be incorporated into the price structure of foods
5. Policy, science, technology, and education
 - a) Continued educational efforts in informing consumers of the relationship between personal food choices, the food systems these choices support, and the associated social and environmental consequences
 - b) Citizen participation in U.S. agricultural public policy (e.g., Farm Bill) in support of funding federal programs that financially support the adoption of conservation farming practices
 - c) Citizen encouragement of agricultural public policies to fund federal programs for alternative agriculture, environmental, and food system research in U.S. agricultural colleges
 - d) Consistent and sustained pressure on the public institutions that direct research trajectories (e.g., Land Grant institutions)
 - e) Integration of conservation farming education into Cooperative Extension services
6. Policy: See Policy Initiatives in Unit 3.4, Sustainable Agriculture and Sustainable Food Systems
7. The importance of human values in shaping agriculture
 - a) Recognize that attitudes toward food are shaped by broad social circumstances such as the cost of living, changes in the roles of women in society, food products advertising, the number of persons directly involved in food production, knowledge of food and agricultural systems and their social, environmental, and health consequences
 - b) With knowledge of food and agricultural systems and the associated social, environmental, and health consequences, individuals may be compelled to emphasize locally produced seasonal and organic foods
 - c) Education on food costs and fast foods may encourage more Americans to spend less money on food outside the home
 - d) Re-emphasizing eating as a social act that builds family and community can assist the necessary changes in diet, the local agricultural economy, and the broader food system

Discussion Questions

ENVIRONMENTAL ISSUES IN MODERN AGRICULTURE, LECTURES 1 & 2

1. Why do you think it is important to understand the environmental impacts of the agriculture and food system?
2. What did you learn from these two lectures that was surprising to you? Why was it surprising? What did you previously assume to be true?
3. What are some of the most concerning issues raised? Why?
4. Are there any topics from these lectures that you are interested in learning more about? Why? How will you go about learning it?
5. How does learning about this material impact the way you intend to participate in the food system (as a farmer, activist, consumer, etc.)?

References & Resources

SUGGESTED READINGS FOR STUDENTS (DESCRIBED BELOW)

- Carpenter et al., 1998
- Teaching the Food System, 2010
- Gliessman, Stephen R., 2014. Chapters 1-2

PRINT REFERENCES & RESOURCES

Altieri, Miguel A. (ed.). 1995. *Agroecology: The Science of Sustainable Agriculture*. Boulder, CO: Westview Press.

Miguel Altieri is one of the pioneers in developing the discipline of agroecology, and this was the first text to lay out its major premises. Rather than present techniques for production, this text proposes an agricultural paradigm based on the science of ecology. The (second) edition contains updated essays, and still provides a thoughtful overview.

Benbrook, Charles M. 1996. *Pest Management at the Crossroads*. Yonkers, NY: Consumers Union.

The clearest summary of environmental, health, policy and economic issues surrounding pest management in the U.S. Its chapters introduce IPM—with an emphasis on biointensive IPM, review of pesticide use and risk, and discussion of economic and policy obstacles to the adoption of IPM.

Benbrook, Charles. M. 2012. Impacts of genetically engineered crops on pesticide use in the U.S.—the first sixteen years. *Environmental Sciences Europe*, 24(1), 1-13.

Carpenter, Stephen, Nina F. Caraco, David L. Correll, Robert W. Howarth, Andrew N. Sharpley, and Val H. Smith. 1998. *Nonpoint Pollution of Surface Waters with Phosphorus and Nitrogen*. Issues in Ecology 3.

Provides an introduction to the ecological impacts of nutrient run-off. Although the article's scope is much broader than agriculture, it explains the biochemical processes that occur when excess nutrients enter waterways; appropriate for non-science majors. Available from www.esa.org/issues.htm

Cooper, Ann. 1999. *Bitter Harvest: A Chef's Perspective on the Hidden Dangers in the Foods We Eat and What You Can Do About It*. New York: Routledge.

Describes the health risks of modern industrial food and lax government oversight of food safety.

Conway, Gordon, and Jules N. Pretty. 2009. *Unwelcome Harvest: Agriculture and Pollution*. Sterling, VA: Earthscan.

An exhaustive overview of the relationship amongst agrochemicals, environmental impacts, and social consequences from a global perspective.

DANR (Division of Agriculture and Natural Resources). 1992. *Beyond Pesticides: Biological Approaches to Pest Management in California*. Oakland: University of California Division of Agriculture and Natural Resources.

A thorough analysis of the production-related problems of pesticide reliance in California; proposes in-creased funding for research and extension of biological methods of pest management in the state.

FitzSimmons, Margaret. 1986. The new industrial agriculture: The regional integration of specialty crop production. *Economic Geography* 62 (4):334-353.

Gliessman, Stephen R. 2014. *Agroecology: The Ecology of Sustainable Food Systems*, 3rd edition. Boca Raton, FL: CRC.

This new edition of the bestselling textbook for courses in agroecology or sustainable agriculture updates the issues facing the sustainability of food systems, especially the strong movement from the "second green revolution" of biotechnology, the continued consolidation of the agricultural and food industries, the conflict with biofuels, and today's historical record of hungry and undernourished people worldwide. Presents recent research and provides new examples throughout, including innovative ways farms and other parts of the food system have introduced new alternative technologies to improve sustainability.

Gurian-Sherman, Doug. 2008. *CAFOs Uncovered: The Untold Costs of Confined Animal Feeding Operations*. Cambridge, MA: Union of Concerned Scientists. www.ucsusa.org/assets/documents/food_and_agriculture/cafos-uncovered.pdf

Gurian-Sherman, Doug. 2009. *Failure to Yield: Evaluating the Performance of Genetically Engineered Crops*. Cambridge, MA: Union of Concerned Scientists. www.ucsusa.org/assets/documents/food_and_agriculture/failure-to-yield.pdf

Hassanein, Neva. 1999. *Changing the Way America Farms: Knowledge and Community in the Sustainable Agriculture Movement*. Lincoln, Nebraska: University of Nebraska Press

Heffernan, William D., Mary Hendrickson, and Robert Gronski. 1999. *Consolidation in the Food and Agriculture System*. National Farmers Union. www.foodcircles.missouri.edu/whstudy.pdf

Provides the clearest and most compelling evidence of the concentrated economic control that a small number of transnational corporations have over the processing and distribution of foodstuffs.

International Service for the Acquisition of Agri-Bio-tech Applications. 2012. *Pocket K No. 16: Global Status of Commercialized Biotech/GM Crops in 2012*. www.isaaa.org/resources/publications/pocketk/16/

Kegley, Susan, Lars Neumister, and Timothy Martin. 1999. *Disrupting the Balance: Ecological Impacts of Pesticides in California*. San Francisco, CA: Californians for Pesticide Reform. www.igc.org/cpr/publications/publications.html

Reports in considerable detail the continuing impacts of agrochemicals on California's ecosystems.

Kegley, Susan, Stephan Orme, and Lars Neumister. 2000. *Hooked on Poison: Pesticide Use in California 1991–1998*. San Francisco, CA: Californians for Pesticide Reform. www.igc.org/cpr/publications/publications.html

Drawing from California's pesticide database, reports patterns of pesticide use in the state by chemical, crop, and county.

Kimbrell, Andrew, ed. 2002. *Fatal Harvest: The Tragedy of Industrial Agriculture*. Washington DC: Island Press.

A coffee table-sized book with many short essays and large photos describing the environmental and social consequences of our modern agricultural system. Provides a thorough identification of the range of consequences from this system. A lower-cost version without photos has all the essays, and would be an appropriate reader for undergraduates.

Kloppenborg, Jack Ralph. 2004. *First the Seed: The Political Economy of Plant Biotechnology, 2nd edition*. Madison, WI: University of Wisconsin.

A brilliant historical analysis of seeds, plant breeding, genetic diversity, and the appeal of biotechnology to capitalism.

Korten, David C. 2001. *When Corporations Rule the World*. Bloomfield, CT: Kumarian Press, Inc.

A central text in the emerging global Living Democracy Movements. Addresses the social and environmental consequences of economic globalization.

Lockeretz, William, ed. 1997. *Visions of American Agriculture*. Ames, IA: Iowa State University Press.

A selection of writings by experts on social and economic evolution in the agricultural sector.

Miller, G. T., and Scott E. Spoolman. 2012. *Living in the Environment, 17th edition*. Belmont, CA: Brooks/Cole Cengage Learning.

Undergraduate-level textbook in environmental science. Addresses prevalent environmental issues including problems in modern conventional agriculture and alternatives.

National Research Council. 1989. *Alternative Agriculture*. Washington, D.C.: National Academy Press.

This book was significant because of the scientific legitimacy it accorded to the emerging sustainable agriculture movement. Its methodology was criticized by both conventional and alternative agriculture advocates. Although its findings and recommendations are not particularly provocative by today's standards, it marked an important milestone in efforts to promote alternative approaches to production.

National Research Council. 1993. *Soil and Water Quality: An Agenda for Agriculture*. Washington DC: National Academy Press.

Provides the most scientifically thorough discussion of the soil and water conservation challenges facing agriculture in the U.S. Although written by scientists, its target audience is policymakers. Clear and well-organized.

Pesticide Action Network of North America. 2009. *Agroecology and Sustainable Development: Findings from the UN-led International Assessment of Agricultural Knowledge, Science and Technology for Development*. San Francisco, CA. www.agassessment-watch.org/docs/PANNA_agroecology_Brief_20090505.pdf

Pimentel, David 2005. Environmental and economic impacts of the application of pesticides primarily in the U.S. *Environment, Development and Sustainability*. 7, 229-252.

Patrick, Wesley S. 2005. *Evaluation and Mapping of Atlantic, Pacific and Gulf Coast Terminal Dams: A Tool to Assist Recovery and Rebuilding of Diadromous Fish Populations*. Department of Biology, East Carolina University. Proceedings of the 14th Biennial Coastal Zone Conference, New Orleans, Louisiana, July 17 to 21, 2005. www.csc.noaa.gov/cz/CZ05_Proceedings/pdf%20files/Patrick.pdf

Pew Commission on Industrial Farm Animal Production. 2009. *Putting Meat on the Table: Industrial Farm Animal Production in America*. A Project of The Pew Charitable Trusts and Johns Hopkins Bloomberg School of Public Health. www.ncifap.org/_images/PCIFAPFin.pdf

Pollan, Michael. 2002. Power Steer. *New York Times Magazine*, March 31.

Describes the modern beef production system, and its human health and environmental impacts.

Pretty, Jules N. 1995. *Regenerating Agriculture*. London: Earthscan.

Would serve well as a textbook for a sustainable agriculture class with a global perspective. Pretty does a good job integrating technical, social, and political changes that need to be put in place to make a transition to more environmentally friendly agriculture.

Reeves, Margaret, Kristin Schafer, Kate Hallward, and Anne Katten. 1999. *Fields of Poison: California Farmworkers and Pesticides*. San Francisco: Californians for Pesticide Reform.

The most complete discussion of California farmworker poisonings. Critiques the weak reporting and even weaker enforcement of farmworker protection laws.

Reisner, Mark. 1993. *Cadillac Desert: The American West and its Disappearing Water*. New York, NY: Penguin Group.

Robbins, John. 1987. *Diet for A New America*. Walpole NH: Stillpoint.

Discusses the human and environmental health impacts of modern agriculture and diet.

Röling, N.G., and M.A.E. Wagemakers, eds. 1998. *Facilitating Sustainable Agriculture: Participatory Learning and Adaptive Management in Times of Environmental Uncertainty*. Cambridge: Cambridge University Press.

Essays explore in detail the social changes necessary to make the technical changes possible for sustainable agriculture. The emphasis and case studies are focused on Europe and the developing world, but the principles are relevant to all.

Sawyer, John, Mark Hanna, and Dana Petersen. 2010. *Energy Conservation in Corn Nitrogen Fertilization – Farm Energy*. Iowa State University – University Extension. store.extension.iastate.edu/Product/Energy-Conservation-in-Corn-Nitrogen-Fertilization-Farm-Energy

Schahczenski, Jeff, and Holly Hill. 2009. *Agriculture, Climate Change and Carbon Sequestration*. ATTRA–National Sustainable Agriculture Information Service. IP 338. attra.ncat.org/publication.html

Provides an overview of the relationship between agriculture, climate change and carbon sequestration. Investigates possible options for farmers and ranchers to have a positive impact on the changing climate and presents opportunities for becoming involved in the emerging carbon market.

Schlosser, Eric. 2001. *Fast Food Nation: The Dark Side of the All-American Meal*. Boston: Houghton Mifflin.

Contains great chapters on food safety, meat packing, and the implications of a fast food diet.

U.S. Department of Agriculture. 2013. *Irrigation & Water Use*. Economic Research Service. Updated June 7, 2013. www.ers.usda.gov/topics/farm-practices-management/irrigation-water-use.aspx#.U2WGuS8oyCQ

U.S. Geological Survey. 2010. Nutrients in the Nation's Streams and Groundwater, 1992-2004. Reston, Virginia: USGS Circular 1350.

University of California Agricultural Issues Center. 2009. *Soil Salinization*. AIC White Papers on California Agricultural Issues. aic.ucdavis.edu/publications/whitepapers/Soil%20Salinization.pdf

USGS. 2000. *Water Quality in the Sacramento River Basin, California, 1994-1998*. Reston, Virginia.

Reports describe a thorough investigation into the water quality in U.S. and California rivers and streams.

Youngberg, Garth, Neill Schaller, and Kathleen Merrigan. 1993. The sustainable agriculture policy agenda in the United States: Politics and prospects. In *Food for the Future*, Patricia Allen, ed. New York: John Wiley.

Wright, Julia. 2009. *Sustainable Agriculture and Food Security in an Era of Oil Scarcity: Lessons from Cuba*. Sterling, VA: Earthscan.

Watts, Jonathon, and John Vidal. 2013. Unease among Brazil's farmers as Congress votes on GM terminator seeds. *The Guardian*. Thursday 12 December 2013. www.theguardian.com/global-development/2013/dec/12/brazil-gm-terminator-seed-technology-farmers

WEB-BASED RESOURCES

Action Group on Erosion, Technology and Concentration (formerly RAFI)

www.etcgroup.org

Dedicated to the conservation and sustainable advancement of cultural and ecological diversity and human rights. Supports socially responsible developments of technologies useful to the poor and marginalized and addresses international governance issues and corporate power.

The Organic Center

organic-center.org

Viewpoints on organic, conventional and genetically engineered farming systems.

Bullfrog Films

www.bullfrogfilms.com

Source of films on environmental issues.

Californians for Pesticide Reform

www.pesticidereform.org

A coalition of over 170 public interest groups dedicated to protecting human health and the environment from the dangers of pesticide use.

Center for Food Safety

www.centerforfoodsafety.org/

Analyzes biotechnology issues.

Extension Toxicology Network

ace.orst.edu/info/extoxnet/

A source of objective, science-based information about pesticides developed by toxicologists and chemists within the Extension Service of the land-grant universities; written for the non-expert. Information fully search-able and selectively retrievable.

Food Quality Protection Act (FQPA)

www.epa.gov/pesticides/regulating/laws/fqpa/

Viewpoints on the FQPA.

Heinz Center

triblive.com/news/allegheeny/4957496-74/heinz-center-endowments#axzz2vhMuCVml

The Heinz Center is a non-profit institution dedicated to improving the scientific and economic foundation for environmental policy through multisectoral collaboration among industry, government, academia, and environmental organizations.

Pesticide Action Network

www.panna.org

An excellent website containing the most recent compilations of studies on pesticide use in California and the U.S.

Sustainable Agriculture Education Association (SAEA)

sustainableaged.org/

(see "Curriculum Library")

Starting in 2014, SAEA will roll out a place where educators can share syllabi, class exercises, assignments, and information about

their degree programs.

Teaching the Food System. 2010. Agriculture and ecosystems: Background reading. A Project of the Johns Hopkins Center for a Livable Future.

www.jhsph.edu/research/centers-and-institutes/teaching-the-food-system/curriculum/_pdf/Agriculture_and_Ecosystems-Background.pdf

UC Sustainable Agriculture Research and Education Program—Agriculture Sustainability Initiative, UC Davis

www.sarep.ucdavis.edu

An excellent website for the discussion of the social, political, ecological, and agronomic aspects of “sustainable agriculture.”

U.S. Geological Survey

water.usgs.gov/nawqa/

Accessible reports and maps on the water quality impacts of non-point source pollution from agriculture. These are appropriate for undergraduate students, and their maps make nice overheads for lectures.

U.S. Geological Survey

water.usgs.gov/ogw/gwrp/stratdir/future.html

The USGS Ground-Water Resources Program’s efforts to examine and report on critical issues affecting the sustainability of the nation’s groundwater resources.

Union of Concerned Scientists

www.ucsusa.org/food_and_agriculture/

Offers a large section on food and agriculture issues. The website includes a particularly useful section on genetic engineering, providing brief overviews as well as several reference documents.

VIDEOS

In Our Children’s Food. 1993. PBS FRONTLINE special. Hosted by Bill Moyers (56 minutes).

Covers human health and environmental risks associated with pesticide exposure. Follows the politics of the development of the National Academy of Sciences’ children’s study: Pesticide residues in the diets of infants and children.

Oliver de Schutter: What is Agroecological Farm-

ing? 2012.

www.youtube.com/watch?v=938PECAJ920

Race to Save the Planet: Saving the Environment and Feeding the World. 1990. WGBH/PBS video.

Explores the human side of international environmental issues in agriculture and the delicate balance between progress and the preservation of the environment.

Diet for a New America. 1991. KCET /PBS video. Hosted by John Robbins (60 minutes).

From the John Robbins book of the same name. Discusses the human and environmental health impacts of modern agriculture and diet.

Playing with Poison. 2001. CBC’s The Nature of Things. Force Four Entertainment (64 minutes).

American anthropologist investigates the side effects on children of pesticide use in Mexico’s Yaqui Valley, one of Mexico’s largest agricultural areas. Available from: www.bullfrogfilms.com

Queen of the Sun: What Are the Bees Telling Us? 2011. By Taggart Siegel and John Bets (83 minutes).

www.queenofthesun.com

An alternative look at the global bee crisis; includes interviews with beekeepers, scientists and philosophers from around the world, who reveal both the problems and the solutions in renewing a culture in balance with nature.

Symphony of the Soil. 2012. Directed by Deborah Koons Garcia (103 minutes)/

www.symphonyofthesoil.com

An artistic and scientific exploration of soil, examining its complex dynamics as well as the human relationship with soil, the use and misuse of soil in agriculture, deforestation and development, and the latest scientific research on soil’s key role in ameliorating the most challenging environmental issues of our time. Filmed on four continents, featuring esteemed scientists and working farmers and ranchers.

Sustainable Agriculture and Sustainable Food Systems

Introduction	75
Lecture 1: A Brief History of Resistance to the “Modernization” of Agriculture	77
Lecture 2: Imagining Alternatives	80
Lecture 3: Food Justice—Current Activities to Address Social Justice Issues in the U.S. Food System	85
Discussion Questions, Lectures 1, 2, and 3	88
References and Resources	89

Introduction: Sustainable Agriculture & Sustainable Food Systems

UNIT OVERVIEW

This unit draws on information presented in Units 3.1–3.3 to help students understand efforts to promote greater sustainability and justice in U.S. food and agriculture systems.

The first lecture presents a short history of efforts to resist agriculture’s modernization, a process that has been driven by increasingly capitalist relationships and the application of new technologies in agriculture. The lecture summarizes early U.S. agrarian populism and efforts to resist the “scientization” of agriculture through the authority of expert knowledge associated with the Land Grant University complex. It then presents the origins of the organic agriculture movement, and describes the impact that Rachel Carson’s *Silent Spring* had on society and public policy. The resurgence of U.S. agrarian populism exemplified by Jim Hightower and Wendell Berry is then covered. The first lecture concludes with an introduction to the concept of “sustainability” in the literature and public discourse.

The second lecture reviews some of the initiatives to promote alternative visions of the U. S. food and agriculture system. It first explains various definitions and dimensions of “agricultural sustainability,” and explores the problems associated with this term. Students will be exposed to the criticism of the way that proponents of “sustainable agriculture” have tended to limit discussions of this issue to farms and farmers, ignoring the broader social con-

text of the food system of which the farm is one part. The lecture then introduces the concept of agroecology pioneered by Steve Gliessman and Miguel Altieri, and the application of ecological principles to the design and management of agroecosystems. The definition and requirements of certified organic food production and the growth and development of the “Organic” food industry over the last ten years are then discussed. This section further addresses concerns over the replication of social and environmental problems caused by the introduction of capitalist relations and federal standards to organic production. The concepts of localizing food systems and creating more integrated relationships between producers and consumers is then introduced. The lecture concludes with a discussion of the difficulties and necessity of policy change needed to move toward greater agricultural sustainability.

The third lecture, on food justice, illustrates how systemic inequities in the food system give rise to movements for social justice and provides an introduction to the complexity, diversity, challenges, and opportunities facing movements for social justice in the food system. It also intends to engage students in a critical reflection on the potential of social movements for systemic change in the food system. The lecture identifies the social justice efforts in the U.S. food system. It discusses briefly the roots and branches—where the movement has grown from and is growing to. The lecture concludes by categorizing different types of solutions to food system problems (food enterprise, food security, food justice, food sovereignty), defining them, and discussing how the overall system can best be transformed.

MODES OF INSTRUCTION

> LECTURES (3 LECTURES, 50 MINUTES EACH)

Three lectures cover the historical populist movements that have attempted to resist the industrialization of agriculture in the U.S., introduce the contemporary sustainable agriculture movements, and explore the social justice movement. References given in the outlines are described in the References and Resources section.

LEARNING OBJECTIVES

CONCEPTS

- The current food and agriculture system is not inevitable; many people and social movements have been working for decades to promote social justice and resource protection in this system. These efforts contest the direction the food system has taken.
- The outline of U.S. agrarian populism, its influence on U.S. culture, and its limited contemporary applicability
- The importance of knowledge questions in the search for sustainable alternatives
- The history of policy initiatives trying to promote more socially just and environmentally responsible forms of agriculture in the U.S., and the challenges facing any effort to promote sustainability at the national level
- The usefulness and limitations of applying the term “sustainability” to agrofood systems
- The value, complexity, and limitations of the agroecological paradigm
- The growth of organic food production and the role that U.S. government regulations have played in creating opportunities for organic agriculture that diverge from the original ideals of the organic farming movement
- The “third way” initiatives in promoting ecologically rational use of agrochemicals in conventional systems
- The different efforts to “localize” the food system and the role they play in promoting sustainability
- The reasons for the emergence of a food justice movement in the U.S.
- The relation and significance of food justice within the larger U.S. food movement
- Dialogue on the role of social movements in food system transformation

Lecture 1: A Brief History of Resistance to the “Modernization” of Agriculture

A. The Current Food System Is Not Inevitable and Reflects Dominant Social Values— Alternatives Will Need To Be Rooted in the Expression of Alternative Values

(see Thompson 1997)

1. The food system in the U.S. is an extreme example of industrialized agriculture (see Unit 3.1, Development of U.S. Agriculture)
 - a) The scale of modern U.S. agriculture
 - b) The concentration of ownership in modern U.S. agriculture
 - c) The use of high technology and industrial processes in modern agriculture
2. For more than a century, critics have protested problematic trends in U.S. agriculture mentioned in previous lectures in Part 3, Social and Environmental Issues in Agriculture
 - a) What kind of food system would we have today if their advice had been heeded?
 - b) Imagination is necessary to create alternatives. You cannot create a food system that you cannot imagine.
 - c) Values other than capitalism and profit will need to be injected into discussions and decisions about agriculture and food to achieve any viable alternatives

B. Early U.S. Agrarian Populism (see Danbom 1997; McConnell 1959; Goodwyn 1978; Mooney and Majka 1995)

1. Major periods of struggle: 1866–1890; 1920s–1930s
 - a) Common theme of two periods: Efforts to protect small, independent farmers from predatory practices of capitalism
2. First period took place as capital from the Eastern seaboard began to dictate economic choices to homestead small holders in the Upper Midwest
 - a) Issues included transportation, economic concentration
 - b) Agrarian populist movements that grew out of this resistance
 - i. Grange network: Served as local forums for farmers to meet and discuss cooperative action for the common good of local agriculture
 - ii. Farmers Alliance: A political effort to promote farmer-owned cooperatives and policies that supported them
 - iii. Populist Party: A political party that ran candidates; it had a vision of agriculture more in line with Jeffersonian democracy, and resisted the political power of railroads and powerful corporations
3. Second period: Agricultural depression foreshadowed national depression
 - a) New Deal responses included: Alternative, communal farms; price supports; acreage reduction programs
 - b) Soil Conservation Service (now Natural Resources Conservation Service, NRCS) grew out of this era also
4. Today: Is agrarian populism possible with the abolishment of subsistence and small-scale farming?
 - a) Solutions must include cooperative action, but with <2% of the population on farms, it must include more than farmers

C. Resistance to the “Scientization” of U.S. Agriculture (see Chapter 2 in Hassanein 1999)

1. Historically, farmers have been the source and guardians of knowledge about agriculture, although this has recently changed
2. The development of the land grant system, experiment station, and agricultural cooperative extension system with a technological and production-centered research agenda removed farmers as the primary source of knowledge
 - a) More scientific methods were brought to bear in agriculture, but with them specialized technologies and practices that marginalized farmers. Their “unscientific” knowledge and lack of financial resources left farmers in an inferior economic and political position.
 - b) Supporters of the land grant system popularized the notion of farmers as stubborn, ignorant, and foolish, “unscientific.” This notion took hold in the popular and political imagination.
 - c) Most agricultural scientists during the middle part of the 20th century saw their work as unquestionably good, advancing the frontiers of modern society. They were by and large blind to the negative impacts of their work.
3. There were three responses by farmers to this development
 - a) Following the program proposed by the land grant complex: Those who had access to land, capital, and technology were able to grow and outcompete their neighbors, often buying them out in the process
 - b) A second group has rejected the entire land grant/cooperative extension project, creating an alternative knowledge base for agriculture. The organic farming movement is an example of this (see Vos 2000).
 - c) A third approach is that of selectively adopting land grant/cooperative extension advice, and perhaps working to make this system more responsive to the contemporary needs of growers
4. Criticism of the land grant complex
 - a) What are the worldview assumptions underlying modern agricultural science? Emphasis on technology where existing relationships of political and economic power are not questioned.
 - i. Example: The issue of world hunger is often understood solely as a problem of underproduction and not maldistribution of an already overabundant food supply
 - b) Whose interests has public agricultural science served?
 - i. It has repeatedly served the financial well being of those with the most capital

D. Early Organic Movement (see Vos 2000; Sustainable Agriculture Research and Education 2012)

1. In England, Lady Eve Balfour and Sir Albert Howard were early leaders; in the U.S., J. I. Rodale along with Rodale Press. Howard’s book, *An Agricultural Testament*, based on his time observing traditional systems in India as well as his own research, greatly influenced Rodale.
2. They were critics of the industrialization of agriculture, arguing that soil health, food quality, and human health were integrally related
3. Their ideas were fused with a more general critique of agriculture and society by the counterculture movement during the 1960s and 1970s to create the organic farming movement

E. *Silent Spring* by Rachel Carson, and Widespread Calls for Change

1. *Silent Spring's* thesis: Massive, ignorant, needless poisoning of the biosphere
2. Why was *Silent Spring* so powerful?
 - a) It was an irrefutable critique of the chemical paradigm in agriculture
 - b) It was an effective critique of the entire enterprise of modernization and better living through technology
3. Social and political impacts of *Silent Spring*
 - a) People began to question the role of science and technology in agriculture and created a popular concern about the environmental and human health risks associated with many modern technologies
 - b) The Environmental Protection Agency (EPA) was created, in part to provide a more objective agency for evaluating pesticide impacts
 - c) Increased public funding and support for integrated pest management (IPM)
4. Fixed the problems of modern agriculture in the popular imagination. Created political space for alternatives.

F. Critics in the 1970s (see Berry 1977)

1. Jim Hightower and *Hard Tomatoes, Hard Times*: Calling for public accountability for public universities and institutions
2. Wendell Berry: A contemporary form of agrarian populism
3. On the margins, a few critics called for land reform in the U.S., especially associated with publicly funded irrigation works, but these arguments never really found much credence in Washington, D.C.
4. *A Time to Choose*: The Bergman (President Carter's Secretary of Agriculture) report on problems in American agriculture

G. Alternative Agriculture and the Development of the Concept of Sustainability

1. 1989: The National Research Council publishes *Alternative Agriculture*
 - a) This was a surprising critique of the model agricultural paradigm
 - b) The report was controversial for its message and method
2. The Brundtland Commission of the UN begins to popularize the notion of sustainability
 - a) This UN commission laid the foundation for the 1992 Rio conference on sustainable development and brought this term into general use
 - b) As a result, the term "sustainable agriculture" gains popularity
 - c) "Sustainability" is a powerful, yet almost undefinable term

Lecture 2: Imagining Alternatives

A. Problematising the Concept of Sustainable Agriculture: What Does Agricultural Sustainability Mean? What Does It Look Like? (see Allen and Sachs, 1991; www.sarep.ucdavis.edu/concept.htm)

1. Common conceptions of sustainable agriculture and their limitations
 - a) Exclusively production oriented, agronomic in nature and farm-centric in focus
 - b) The problems are inaccurately framed as only technical problems and thus requiring only technological solutions
 - c) Fails to recognize the influence of social institutions on the soundness of farming practices and the food system
 - d) Fails to equally recognize both the social and environmental problems resulting from the dominant agricultural model
2. Questioning objectives of sustainable agriculture: "What is it that we want to sustain, or change?"
 - a) Whose needs should be emphasized?
 - b) Which of their needs should be prioritized?
 - i. Consumers and cheap food prices?
 - ii. Environmental quality?
 - iii. Fair prices to growers?
 - iv. Low pesticide residues in foods?
 - v. Workers: Wages, working conditions, or year-round employment?
3. Sustained over what time frame?
 - a) Long-term versus short-term planning
4. What scale does this term get used at?
 - a) Field? Farm? Watershed? Region? Nation? Globe?
 - b) The unit of analysis largely determines what needs to be sustained
5. Comprehensive definitions of agricultural sustainability
 - a) Many advocates for sustainable agriculture recognize the need to integrate at least the following indicators: ecological, economic, and social (see asi.ucdavis.edu/sarep/about-sarep/def/)
 - b) How shall we define these other qualities? Questions for discussion:
 - i. How do we define "environmental quality"?
 - ii. How do we define social justice?
 - iii. How do we define human health?
 - iv. How do we define economic viability of small farmers?
 - v. How do we define life quality of rural agricultural communities?
 - c) What we define as goals in sustainable agriculture will influence the means and outcomes

B. Agroecology: Altieri and Gliessman (see agroeco.org, www.agroecology.org)

1. Agroecology defined: Applying the principles of ecology to the design and management of sustainable agricultural ecosystems
2. Altieri defines agroecology as: A scientific discipline that uses ecological theory to study, design, manage, and evaluate agricultural systems that are productive but also resource conserving

3. Strong emphasis on enhancing biological diversity of both the soil ecosystem and terrestrial plant associations in and around agricultural production systems
4. Advantages
 - a) Looks at farms as agroecosystems that are subject to human disturbances
 - b) Encourages returning more autonomy to the farmer through farmer as expert
 - c) Emphasizes understanding, managing, and enhancing ecological processes for soil fertility and pest management in order to reduce reliance on costly and damaging external inputs
5. Agroecology also prioritizes food security, social equity, economic viability and resource conservation in its broad view (see also de Schutter 2012 under Resources, Lecture 3)
6. Problems
 - a) How big is the system? How big an agroecosystem can be measured or managed?
 - b) What happens if the farm is ecologically sustainable, but not commercially viable?

C. Organic Agriculture

1. Organic agriculture today (see www.ams.usda.gov/nop/)
 - a) Defined: A system of agriculture that encourages healthy soil and crops through such practices as nutrient and organic matter recycling, crop rotations, proper tillage, and the strict avoidance of synthetic fertilizers and pesticides for at least three years prior to organic certification
2. Organic agriculture is currently the fastest-growing sector of the food market (Smith 2012; also see Organic Trade Association, www.ota.com)
 - a) U.S. sales of organic in 2010 were 26.7 billion, up from 1 billion in 1990
 - b) In 2010, 11% of all fruit and vegetable sales were organic
 - c) Mainstream markets were responsible for 54% of organic product sales
3. The development of the organic movement and the National Organic Standards (see Vos 2000)
 - a) The rationale behind organic certification: To assure consumers that food has been produced in accordance with a specific set of conservation farming practices
 - b) The rationale behind the national organic standards: To make the certification standards for export/import agriculture more uniform
4. Shortcomings of organic production and criticisms of the national organic standards (see Pollan 2001, Philpott 2012)
 - a) Production practices of most organic growers fall far short of both the agroecological and the organic ideal (see Guthman 2000)
 - i. Off-farm inputs: Chilean nitrate, guanos, mined materials
 - ii. Energy use: Organic agriculture does not necessarily use less energy, and may in fact use more
 - iii. Weed control measures: Relies heavily on poorly paid hand labor. Which method is more sustainable?
 - b) Who serves to benefit most from the National Organic Program (NOP): Food processors?
 - c) NOP maintains less stringent standards than previous third-party certifying agencies
 - d) NOP places small growers at an economic disadvantage by requiring practices that require expensive equipment
 - i. Example: Compost production requirements (see Unit 1.7, Making and Using Compost, for information on NOP compost-making requirements)
 - e) The effectiveness of the National Organic Standards Board as an advisory council for USDA remains questionable (Strom 2012; Jaffee and Howard 2010)

- f) The “organic industrial complex”: The replication of the industrial model of agriculture in organics (see Buck et al. 1997; Pollan 2001; Howard 2009)
 - i. The organic commodity chain is identical to that of conventional agriculture
- 5. Despite shortcomings, organic offers important alternative to conventional agriculture (Philpott 2012)
 - a) Food is produced without synthetic and persistent chemicals (keeping them out of people, particularly farm workers and farmers). Genetically modified seeds are excluded, meat is produced without constant (technically any) use of antibiotics, and soil-preserving practices are required.

D. Alternative Agriculture: A Third Way? (see Swezey and Broom 2000)

1. Integrated Pest Management (IPM) and “agricultural partnerships”: Initiatives to develop management systems for industrial agriculture that do not prohibit the use of agrochemical inputs. Systems are based on agroecological principles and the gathering of appropriate local knowledge of a farming system.
2. Agricultural partnerships are based on a critique of the conventional extension system, which tends to treat growers as passive recipients of knowledge. Influenced by the “farmer-to-farmer” approach to knowledge generation practiced in the developing world.
3. In California these partnerships have reduced the environmental impact of agriculture, and show genuine promise of influencing a large number of growers in some cropping systems
4. Shortcomings of approach: Does not raise questions about the social problems resulting from the current organization of the food and agriculture system

E. Re-localizing a Food System (see Allen 2004; Clancy 1997; USDA 2014)

1. Strategic choices: Sustainability advocates balancing their interest in improving the environmental performance of agriculture with other problems in the food system
2. “Localizing” the food system: Connecting local growers with local eaters
 - a) Promoted as a way to reduce hunger and enhance the economic viability of smaller farms that adopt conservation farming practices
3. Criticisms of the modern food system (see Clancy 1997)
 - a) The modern food system as a “dis-integrated” food system
 - i. Consumers have lost a relationship with the production of their foods
 - ii. Growers have lost contact with the eaters that consume the food they grow
 - iii. There are enormous hidden costs associated with the global food system and cheap food
4. Efforts to promote local food systems
 - a) Local food initiatives (e.g., Buy Fresh Buy Local; see www.caff.org) to reduce barriers between producers and consumers
 - b) Food policy councils, which help institutions and individuals recognize the advantages of buying local foods, and facilitate interactions with farmers
 - c) Food hubs, places where food can be aggregated from smaller-scale farms to larger volume buyers
 - d) Farm-to-school efforts, which allow local growers to sell to supportive institutions
 - e) Farmers’ markets and Community Supported Agriculture (CSA) are considered staple activities in re-localizing food systems
 - f) Institutionalized in USDA—see *Know Your Farmer, Know Your Food initiative* (USDA 2014). Goal is to help “ . . . communities scale up local and regional food systems and strengthen their economies.”

5. The emergence of the community food security movement (see Lecture 3 of this unit for more information)
 - a) Fundamental assumptions: That all people have a right to access local, nutritious, culturally appropriate, non-emergency food
 - b) Links anti-hunger efforts with sustainable agriculture, economic development, and social justice advocacy

F. Policy Initiatives (see Youngberg et al. 1993; Marshall 2000)

1. Large-scale economic reforms that advocates have not been able to figure out how to implement in the U.S.
 - a) Land reform: Making small-scale production possible for those without access to large amounts of capital
 - b) Market reform: Preventing large growers, large manufacturers, and intermediaries from taking advantage of small-scale producers
2. Sustainability at a national scale: Making policies serve this vision
 - a) Greater enforced restrictions on the domestic and international use of pesticides and synthetic fertilizers
 - b) Ban on the use of GE organisms until long-term studies provide conclusive evidence on environmental quality and human health risks
 - c) Legislation leading to the eventual elimination of all toxic pesticides
 - d) Increased federal funding for research on organic and sustainable soil fertility and pest management practices
 - e) Increased federal funding for research on the development of economically sustainable regional food systems
 - f) Increased funding for regional and local food security initiatives
 - g) Increased funding for extension work in training farmers in alternative production practices
 - h) Increased access to low-interest credit for farmers to use in transitioning from conventional agriculture to certified organic production practices
 - i) Anti-trust legislation discouraging the concentration of ownership in the food system
 - j) Federal small farm subsidies to increase the adoption of conservation farming practices
 - k) Initiate program to assess the true cost of socially just and environmentally sound production practices: "True cost accounting"
 - l) Identify actors within the food system responsible for the externalized costs of production (e.g., pesticide manufactures, farmers)
 - m) Internalize the true costs of production by readjusting price structure of agricultural products to better represent actual costs of production
3. Obstacles to these initiatives
 - a) Political forces are deeply invested in the current agricultural model
 - b) The cheap food dilemma
4. Current policies being advocated: See National Coalition for Sustainable Agriculture 2012
5. The U.S. Farm Bill (see National Coalition for Sustainable Agriculture www.sustainableagriculture.net)
 - a) The influence of the U.S. Farm Bill
 - i. It sets policy for what will be funded regarding agriculture, but it also greatly impacts food and conservation issues.

- b) Recent outcomes in the 2014 Farm Bill
 - i. More money was allocated to programs for beginning farmers, local food systems, rural development, organics, and specialty crops. Crop insurance subsidies now have conservation requirements attached, and several riders were rejected that could have harmful impacts on competition, the environment, and commerce. However, other subsidy programs reforms, meant to more fairly distribute subsidies, were not enacted. Food stamps, a large portion of the Farm Bill, were cut significantly.
- 6. Local policies and initiatives: Sometimes local groups can effect small-scale change. Advocates still need to engage national policy, but there are some opportunities at the local level.
 - a) Land use policy: Designating food belts
 - b) Directing public institutions to buy from small or local sources

G. Summary and Conclusion: How Do We Promote Sustainability in the Agriculture and Food System?

1. To be effective, any effort has to understand the complexities of agriculture: It is framed by economic, social, and biological processes. All three need to be taken into account.
2. Effective social change generally includes oppositional and alternative efforts: Evolving reforms and promoting a revolutionary vision at the same time
3. Modern agriculture has been shaped directly by the advance of capitalist social relations and the application of science and technology to production practices. Behind these forces are a whole range of social forces. Policy reform is important, but ultimately, addressing these broader forces must be part of efforts to promote a more sustainable agriculture and food system.

Lecture 3: Food Justice—Current Activities to Address Social Justice Issues in the U.S. Food System

A. Food Justice—A Definition

1. There are several definitions in use—there is no one agreed-upon description
2. Definition for this discussion: Food justice sees the lack of healthy food in poor communities as a human rights issue and draws from grassroots struggles and U.S. organizing traditions such as the civil rights and environmental justice movements

B. Got Social Justice? A Quick Overview of the U.S. Food Movement (see Pollan 2010; Berry 1978; Gottlieb and Joshi 2010; Alkon and Agyeman 2011; Guthman 2004, 2011)

1. Back to the land/organics/Agrarian Populism: resistance and alternatives to industrial agriculture (see Lectures 1 and 2, Unit 3.4 for more details)
2. Rising food insecurity and diet-related diseases, food contamination, and environmental externalities of the U.S. food system provoke growing reaction by consumers and producers for alternatives
3. Global food crisis also affect consumers in the United States (Conner et al 2008, Holt-Giménez and Peabody 2008)
4. Farmer's markets, Community Supported Agriculture, food policy councils: The goals of many of these efforts are to democratize and localize the food system.
 - a) Food policy councils generally work on both of these issues specifically (Harper et al 2009, Food First 2009)
 - b) Community Supported Agriculture's (CSA's) initial aims focused on democracy by sharing the economic risk of farming beyond just the farmer
 - c) All of these aim to localize the food system more broadly
 - d) For underserved communities, the challenge is to keep the food dollar in the community where it can recycle 2–5 times, helping to grow the local economy (see Meter 2011)
5. Urban farming/gardening: Taking food and diet into our own hands
 - a) Many organizations and local communities have started growing food to increase food security, provide a more healthy diet, and provide autonomy over the production of food. This follows a worldwide trend: 15–30% of the world's food is produced through urban farming by 800 million farmers.
 - b) In Cuba, because of strong government support, Havana, Santiago, and other major cities receive 70% of their fresh fruits and vegetables from urban farmers. Havana produces 1kg of vegetables per capita per day on 70,000 peri/urban hectares (Murphy 1999, Chan and Roach 2012).
6. Foodies: Affluence, pleasure, and the passion for perfect food, questioning mass-food and re-establishing consumer-producer linkages—for those who can afford it. This is challenged by the more progressive wing of the Slow Food Movement, which takes a stand on food justice (Viertel 2012).
7. Community Food Security: From individual food insecurity to community-based solutions, the USDA, and the rise and fall of the Community Food Security Coalition (CFSC)

- a) In 1994 the CFSC tries to unite anti-hunger, sustainable agriculture, environmentalists, farm labor advocates, and health and nutrition groups behind the “Community Food Security Empowerment Act,” which is attacked by conservatives. The coalition fractures as each group negotiates for its own interests but gains relatively little in the 1996 “Freedom to Farm” Bill. The 2002 Farm Bill includes the Community Food Projects Program and the concept of “Community Food Security” is integrated into the USDA.
 - b) Despite internal divisions amongst CFSC’s different groups’ interests, the 2008 Farm Bill marked a high point in the Coalition’s impact on the Farm Bill and its profile as the national organization representing the food movement. The CFSC’s yearly gathering began with 30 people and grew to over 1000 at the last Conference held in Oakland in 2011. These served to network many organizations and build broad public interest and awareness in the Community Food Movement. This helped influence the Farm Bill to increase its funding for food stamps, funding for specialty crop farmers, farm to school, new farmers, etc. Internal struggles at the CFSC over issues of white privilege and the tension between food justice and food security approaches to social change led to many organizations made up of people of color leaving and forming the Growing Food and Justice for All Initiative.
 - c) The global food crisis, followed by the global recession and the turn towards fiscal conservatism, combined with internal difficulties, led to the CFSC’s financial decline. The CFSC shut down in August 2012 after 16 years of food movement leadership, creating a political-institutional vacuum that has yet to be filled.
8. Food Justice: Dismantling racism in the food system from farm to fork, Growing Food and Justice for All Initiative, Coalition of Immokalee Workers, Food Chain Worker’s Alliance, Restaurant Opportunity Center, U.S. Food Sovereignty Alliance (USFSA)
- a) The structural racism in the food system is reflected not only in the lack of access to fresh, healthy food in underserved communities, but by the poor wages and labor conditions of food workers, many of whom are immigrants, and discrimination in land, credit, and commodity markets, all of which disproportionately impact people of color. The Food Justice movement in the U.S. seeks equal access to healthy food, fair wages and good working conditions, and an end to discrimination against farmers of color.
 - b) Growing Food and Justice for All Initiative, a network hosted by Growing Power (www.growingpower.org) works to dismantle racism to bring about new, healthy, and sustainable food systems and support multicultural leadership in impoverished communities; see more at Supplement 3, The Good Food Revolution at Growing Power, in Unit 1.7, Making and Growing Compost
 - c) Food Chain Workers Alliance and members of the Restaurant Opportunity Center (ROC) work to improve wages and working conditions of food workers, most of whom are people of color
 - d) Coalition of Immokalee Workers (CIW) works to end slavery in Florida’s tomato fields and provide workers with a decent wage. CIW has waged a highly successful Fair Food campaign/boycott with students and churches (see www.foodchainsfilm.com).
 - e) The U.S Food Sovereignty Alliance awards the yearly Food Sovereignty Prize (in opposition to the World Food Prize) to recognize organizations that are democratizing food systems and rebuilding local economies from the bottom up

C. The Political Economy behind Food Justice (see Holt-Giménez, Patel and Shattuck 2010)

1. The world food crisis and the construction of the corporate food regime
2. Overproduction, hunger, food insecurity, and diet-related diseases
3. Land grabs, concentration, and financialization, a rural and urban trend undermining food security (Wang, Holt-Giménez and Shattuck 2011)

D. Roots and Branches of the Food Justice Movement (see Holt-Giménez & Wang 2011; Holt-Giménez et.al. 2011; Holt-Giménez 2010; Jayaraman 2013; Holmes 2013)

1. Environmental justice: Analysis of disproportionate negative externalities systematically visited on underserved populations of color is tuned on the food system and diet-related diseases
2. Liberation struggles: The Black Panthers' 10-point platform for Black liberation includes demands for the right to food, land, and health. First national children's community breakfast program without philanthropic or government support (Patel 2012).
3. Civil rights/human rights: Right to food based on national struggles for civil rights and international human rights
4. Anti-hunger: How overproduction creates new consumer markets, aid institutions (food pantries, food banks) and ensures food insecurity
5. Farm/food labor: Farm and food workers are the most food insecure and physically/legally vulnerable workforce in the nation, however, labor rights, and wages are the organizing principles of this primarily immigrant workforce (UFW, CIW, ROC, Food Chain Workers Alliance—see above) (Brent 2010)
6. Youth and food justice: The emerging leadership for grassroots social change (Steele 2010)
7. Agroecology: The science of sustainable agriculture has applications in the U.S. and in urban settings (Schutter 2011)
8. Spreading resistance to the corporate food regime and deepening of food justice alternatives:
 - a) From Fair Trade Coffee (Bacon et al 2012) to Domestic Fair Trade (Domestic Fair Trade Association, www.thedfta.org)
 - b) Food bombs, Food hubs and Food Commons: the different forms of activism
 - c) Are urban gardens gentrifying neighborhoods?
 - d) Food celebrities: Who speaks for the Food Movement?

E. Food Security, Food Justice, or Food Sovereignty? (see Holt-Giménez and Shattuck 2011a, Holt-Giménez and Shattuck 2011b, Holt-Giménez and Wang 2011)

1. Food regimes and counter-movements; the corporate food regime, neoliberalization, and the food movement as an historic counter-movement
2. Food enterprise, food security, food justice, food sovereignty: The major trends and characteristics in the food regime and the food movement, their main institutions, orientation, model, approach to the food crisis and guiding documents
3. Cooptation, division, fragmentation, and stratification: The struggle for hegemony amongst neoliberal, reformist, progressive, and radical forces
4. The pivotal role of food justice: How the food justice movement determines the political direction of the food movement in the U.S.
5. Repolitization, convergence in diversity, strategic vs tactical alliances: The political challenges to transforming the U.S. food system

Discussion Questions

SUSTAINABLE AGRICULTURE & SUSTAINABLE FOOD SYSTEMS, LECTURES 1-3

1. What surprised you most about the activities resisting the conventional food and agriculture system?
2. What strategies are you most familiar with?
3. Which ones do you want to learn more about, and why?
4. Where do you think the food movement is going? How will it evolve next?
5. What does a socially just food system look like?
6. How does this socially just food system that you envision relate to what you hope to do in the future?

References & Resources

SUGGESTED READINGS FOR STUDENTS: LECTURES 1 & 2 (DESCRIBED BELOW)

- Allen, Patricia. 2004
- Danbom, David. 1997
- Pollan, Michael. 2001

SUGGESTED READINGS FOR STUDENTS: LECTURE 3

- Holt-Giménez, Eric and Yee Wang. 2011

LECTURES 1 & 2

PRINT RESOURCES

Allen, Patricia. 2004. *Together at the Table: Sustainability and Sustainance in the American System*. University Park: Pennsylvania State University Press.

Examines the growth and development of alternative food system initiatives in the U.S., including: The growth of organic farming and the development of the USDA National Organic Program; the growth in popularity of direct marketing relationships such as farmers' markets and community-supported agriculture (CSA); the growth of urban agriculture and community garden programs; the increase in natural and social science research programs focused on sustainable food and farming systems.

Allen, Patricia. 1993. *Food for the Future: Conditions and Contradictions of Sustainability*. New York: Wiley and Sons.

Challenged definitions of sustainable agriculture that did not incorporate social issues, such as justice, gender, ethnicity, or class. If advocates do not heighten their awareness of the social forces pressing on conventional agriculture, they run the risk of reproducing the same social problems in alternative agriculture. This book had a significant impact on academic thinking in the sustainable agriculture movement. The chapter by Allen and Sachs is particularly important and influential.

Allen, Patricia, and Carolyn Sachs. 1991. *What Do We Want to Sustain? Developing a Comprehensive Vision of Sustainable Agriculture*. Sustainability in the Balance, Issue Paper No. 2. Santa Cruz, CA: Center for Agroecology & Sustainable Food Systems, UC Santa Cruz. casfs.ucsc.edu/about/publications

A critique of definitions of sustainable agriculture that are limited only to what happens on the farm. Challenges its readers to reformulate definitions of sustainable agriculture to include gender, race, class, and is-sues in society at large. More appropriate for lower-division students than Allen 1993 (see above).

Allen, Patricia, and Martin Kovach. 2000. The capitalist composition of organic: The potential of markets in fulfilling the promise of organic agriculture. *Agriculture and Human Values* 17:221-232.

Explores the problems and possibilities associated with the increasing demand for organic agriculture.

Berry, Wendell. 1996. *The Unsettling of America: Culture and Agriculture*. San Francisco: Sierra Club.

A classic in contemporary agrarian philosophy written in an accessible style. Berry critiques the dominant industrial agriculture paradigm with his common sense prose, exposing the social, economic and ecological damage it caused. For this course, chapters 3, 4, and 9 are most appropriate. "The Ecological Crisis as a Crisis of Agriculture" describes the way conservationists and capitalists both objectify land and split it off from human culture. "The Agricultural Crisis as a Crisis of Culture" describes the social implications of a culture's alienation from the soil. "Margins" relates several stories of farmers who are intentionally creating alternatives.

Bosso, Christopher J. 1987. *Pesticides and Politics: The Life Cycle of a Public Issue*. Chapter 2, The Pesticides Paradigm, pages 21-45, and chapter 4, The Apotheosis of Pesticides, 61-79. Pittsburgh: University of Pittsburgh.

This book describes the enduring impact Silent Spring had on U.S. agriculture and pesticide policy.

Buck, Daniel, Christina Getz, and Julie Guthman. 1997. From farm to table: The organic vegetable commodity chain of northern California. *Sociologia Ruralis* 37 (1):3-20.

Describes the role that organic certification has had in shaping organic agricultural production

and how the distribution of this produce has begun to mimic that of the conventional food system. Places these developments in the broader framework of agrarian political economy.

Carson, Rachel. 2002. *Silent Spring*. Boston: Houghton Mifflin.

This book probably did more to instigate the environmental movement of the 1960s than any other. Unintentionally, it appears to have contributed to the alienation of the U.S. public from agricultural issues. Chapters 1 and 2 provide an overview of the chemical agriculture mindset, and chapters 3 and 4 introduce toxic agrochemicals and their environmental impacts. Chapter 17 describes alternative trajectories for human-environment relationships.

Clancy, Kate. 1997. Reconnecting farmers and citizens in the food system. In *Visions of American Agriculture*, W. Lockeretz (ed). Ames: Iowa State University Press.

Discusses the major factors that have weakened the links between farmers and the rest of the U.S. population. Clancy then provides criteria that must be met for a more integrated food system, including a more agriculturally literate society, local food security, and supportive institutions and policies. An ideal chapter for a beginning discussion of what needs to happen off the farm to promote social sustainability.

Danbom, David. 1997. Past visions of American agriculture. In *Visions of American Agriculture*, W. Lockeretz (ed.). Ames, Iowa: Iowa State University Press.

Introduces the history of conflicting views of U.S. agriculture: Agriculture as enterprise vs. agriculture as social enterprise. Provides a helpful introduction to the history of American agrarian populism.

Goodwyn, Lawrence. 1978. *The Populist Moment: A Short History of the Agrarian Revolt in America*. Oxford University Press.

Guthman, Julie. 2000. Raising organic: Grower practices in California. *Agriculture and Human Values* 17: 257-266.

This article is based on Julie Guthman's fieldwork investigating the actual practices of organic growers in California. She discovered that organic farms usually comply with organic regulations, but still fall short of the

agroecological ideal, with larger farms and mixed organic/conventional farms least likely to fulfill this ideal. Describes the way in which organic certification has helped the organic farming sector grow and become more like conventional agriculture.

Hassanein, Neva. 1999. *Changing the Way America Farms: Knowledge and Community in the Sustainable Agriculture Movement*. Lincoln, Nebraska: University of Nebraska Press.

Describes the emergence of alternative networks of agricultural knowledge among dairy farmers in Wisconsin, with a special emphasis on issues of gender. Chapter 2, "Knowledge questions in the sustainable agriculture movement," provides an excellent overview of how farmers resisted the hegemony of Land Grant University scientists.

Howard, Sir Albert. 1947. *The Soil and Health*. New York: Schocken Books.

This is an early classic in the organic movement, presenting many of the underlying ecological and philosophical principles still relevant today.

Howard, Philip H. 2009. Consolidation in the North American organic food processing sector, 1997 to 2007. *International Journal of Sociology of Agriculture and Food* 16 (1): 13-30. www.ijisaf.org/archive/16/1/howard.pdf

Jaffee, Daniel & Philip H. Howard. 2010. Corporate cooptation of organic and fair trade standards. *Agriculture and Human Values* 27(4), 387-399.

Kloppenborg, Jack, John Hendrickson, and George W. Stevenson. 1996. Coming into the foodshed. *Agriculture and Human Values* 13 (3): 33-42.

Explores the conceptual and practical opportunities of organizing agricultural production around "food-sheds." Just as bioregionalists propose watersheds as an organizing framework for activism, so agricultural activists are working for local economies of food. Students often respond with enthusiasm to the imaginary this article proposes.

Marshall, Andrew. 2000. Sustaining sustainable agriculture: The rise and fall of the Fund for Rural America. *Agriculture and Human Values* 17: 267-277.

Marshall details the challenges facing any policy initiative in support of sustainable alternatives,

and the political and economic obstacles such an initiative must overcome. Helpful complement to Youngberg et al.

Mooney, Patrick H., and Theo J. Majka. 1995. *Farmers' and Farmworkers' Movements: Social Protest in American Agriculture*. Twayne Publishers.

National Coalition for Sustainable Agriculture. 2012. Farming for the future: A sustainable agriculture agenda for the 2012 food and farm bill. Washington DC. sustainableagriculture.net/wp-content/uploads/2008/08/2012_3_21NSACFarmBillPlatform.pdf

National Research Council. 1989. *Alternative Agriculture*. Washington, DC: National Academy Press.
The highest-ranking report up to that time to legitimize alternatives to the high-input, high-chemical-use model.

Philpott, Tom. 2012. How the NY Times went too far in slamming big organic. *Mother Jones*. July 11. www.motherjones.com/tom-philpott/2012/07/corporate-influence-turned-organic-fraud

Pollan, Michael. 2001. Behind the organic-industrial complex. *New York Times Magazine* May 13. www.nytimes.com/2001/05/13/magazine/13ORGANIC.html
This investigative journalism piece reached a wide audience, and brought the disturbing news that the organic ideal in the minds of many alternative consumers is very far from the reality of the contemporary organic food processing and distribution system. Useful to read side by side with the Kloppenburg et al. article.

Rosset, Peter A., and Miguel A. Altieri. 1997. Agroecology versus input substitution: A fundamental contradiction of sustainable agriculture. *Society and Natural Resources* 10 (3):283-295.
Critiques efforts to make conventional agriculture more sustainable, claiming that only a fully integrated agroecological farming system is truly sustainable.

Smith, Ned. 2012. Organic food sales growth outpaces rest of grocery industry. *BusinessNewsDaily*. April 23. www.businessnewsdaily.com/2404-organic-industry-healthy-growth.html

Strom, Stephanie. 2012. Has 'organic' been oversized? *New York Times*. July 7. www.nytimes.com/2012/07/08/business/organic-food-purists-worry-about-big-companies-influence.html?pagewanted=3&_r=3&hp

Sustainable Agriculture Research and Education. 2012. *History of Organic Farming in the United States*. www.sare.org/Learning-Center/Bulletins/Transitioning-to-Organic-Production/Text-Version/History-of-Organic-Farming-in-the-United-States

Swezey, Sean L., and Janet C. Broome. 2000. Growth predicted in biologically integrated and organic farming. *California Agriculture* 54 (4):26-36.

Describes the growing interest in promoting biologically integrated farming systems in California, a "third way" farming system that draws from knowledge gained by organic systems, reducing yet not fully abandoning agrochemical usage. A provocative companion to Rosset and Altieri.

Thompson, Paul B. 1997. Agrarian values: Their future place in U.S. agriculture. In *Visions of American Agriculture*, W. Lockeretz (ed.). Ames, Iowa: Iowa State University Press.

Thompson develops the two main currents in U.S. agriculture proposed by Danbom (see above), describing the values and ethics inherent in each, and how activists might secure a future for more communitarian ethics in the future of U.S. agriculture.

United States Department of Agriculture. 2014. Know your farmer know your food. www.usda.gov/wps/portal/usda/usdahome?navid=KNOWYOURFARMER

Vos, Timothy. 2000. Visions of the middle landscape: Organic farming and the politics of nature. *Agriculture and Human Values* 17:245-256.

Youngberg, Garth, Neill Schaller, and Kathleen Merrigan. 1993. The sustainable agriculture policy agenda in the United States: Politics and prospects. In *Food for the Future*, P. Allen, ed. New York: John Wiley.

Reviews the impact and implications of sustainability for agricultural policy making. Describes the difficulty of translating the values and visions of sustainable agriculture into concrete policy, and the tendency for political leaders to adopt the discourse of sustainability yet little more. A useful roadmap for charting a course towards improved policy efforts.

WEB-BASED RESOURCES

Agroecology in Action

www.agroeco.org/

Miguel Altieri's website has several useful summary essays about agroecology and agroecological principles. The section titled "Agroecology and Modern Agriculture" has the essays most relevant to this chapter.

National Campaign for Sustainable Agriculture

www.sustainableagriculture.net/index.htm

The National Campaign for Sustainable Agriculture is an umbrella organization for many local groups working for more sustainable agricultural policies in the U.S.

SAREP: What is Sustainable Agriculture?

www.sarep.ucdavis.edu/sarep/

Provides a nice overview of the key themes in sustainable agriculture, especially as they relate to California. Presents information on natural resources, production practices, and the social and economic context of sustainability issues.

Union of Concerned Scientists

www.ucsusa.org/food_and_agriculture/

The Union of Concerned Scientists runs a "Food and Agriculture" Campaign, whose goal is to create a more sustainable food system. They report on issues such as anti-biotic misuse, genetic engineering, industrial agriculture and the Farm Bill.

VIDEOS

Goodbye Mrs. Ant. 1992. A BBC-TV production in association with Lionheart Television International, Inc. Northbrook, IL: Coronet Film & Video (58 minutes).

An overview of the ecological impact of agricultural chemicals on the environment, and the Silent Spring-inspired efforts to regulate them. A good review of the popularity of DDT and the scientific enterprise that supported it.

My Father's Garden. 1995. Miranda Productions Inc.; producer, Abigail Wright; director, Miranda Smith; writer, Nathaniel Kahn (58 minutes).

Weaves together the personal stories of the loss of family farms, the role of chemical pesticides in changing the structure of American agriculture, and Fred Kirschmann's efforts to make his farm ecologically and economically sustainable. Available from: www.bullfrogfilms.com

The Living Land. 1998. Foundation for Global Community (27 minutes).

A thoughtful set of interviews with John Jeavons, Wes Jackson, Alice Waters, and Mas Masumoto on the values and practices of alternative agriculture. Available from: www.globalcommunity.org/cgvideo/land.htm

Miguel Altieri. 2012. Why is agroecology the solution to hunger and food security.

<https://www.youtube.com/watch?v=2yFvD8wuLmU>

LECTURE 3

INSTRUCTOR'S NOTE: Many of the resources listed below are original sources. For concise 1,800–2,000 word syntheses of the issues in this lecture, please see *Food First Backgrounders* referenced in the outline. These are very accessible for undergraduates.

Alkon, Alison Hope, and Julian Agyeman (eds.). 2011. *Cultivating Food Justice: Race, Class, and Sustainability*. Cambridge, MA: MIT Press.

This edited book offers a series of narratives exploring how race and class are intertwined in the food system. Its premise is that much of the food movement has come from white and middle-class people, who come from a shared perspective. This book intends to provide a broader critique of the industrialized food system, including injustice in the conversation.

Bacon, Chris, et al. 2012. *The Struggle for Food Justice in Fair Trade*. CA: Food First Backgrounder, Winter 2012. foodfirst.org/publication/the-struggle-for-food-justice-in-fair-trade/

Berry, Wendell. 1986. *The Unsettling of America: Culture and Agriculture*. San Francisco, CA: Sierra Club.

Brent, Zoe. 2010. *Food Workers—Food Justice: Linking Food Labor and Immigrant Rights*. Oakland, CA: Food First Backgrounder, Summer 2010. foodfirst.org/publication/food-workers-food-justice-linking-food-labor-and-immigrant-rights/

Chan, May Ling Chan, and Eduardo Freyre Roach. 2012. *Unfinished Puzzle—Cuban Agriculture: The Challenges, Lessons, and Opportunities*. Oakland, CA: Food First Books. foodfirst.org/shop/books-dvds/unfinished-puzzle-cuban-agriculture-the-challenges-lessons-and-opportunities/

Food First. 2009. *Democracy in Action: Food Policy Councils*, CA: Food First Backgrounder, Fall 2009. foodfirst.org/publication/democracy-in-action-food-policy-councils/

de Schutter, Olivier. 2012. *Agroecology: A Path to Realizing the Right to Food*. Oakland, CA: Food First Backgrounder, Summer 2011. foodfirst.org/publication/agroecology-a-path-to-realizing-the-right-to-food/

Global Exchange. *Anti-Oppression Reader*. 2006. www.seac.org/wp-content/uploads/2011/07/AO_Reader_2007.pdf

An excellent resource for individuals and groups who are working to address social justice issues, both within the food system and outside of it. The purpose of the manual is to help create safe spaces for all to be valued and heard. The articles explore how oppression exists and manifests in its many forms, how we can see our role in it, and to ultimately to “. . . increase awareness about multi-paradigm experiences and increase understanding about responsibility and accountability of systems of power and privilege” p.2.

Gottlieb, Robert, and Anupama Joshi. 2010. *Food Justice*, Cambridge, MA: MIT Press.

This book describes the myriad issues pertaining to food justice, such as farmworkers’ and meat processing workers’ conditions, food access issues, and over-processing of food. The book also describes the food justice movement that has arisen from these conditions. It tells the stories of groups and individuals working to make change, both in the U.S. and internationally.

Guthman, Julie. 2011. *Weighing In: Obesity, Food Justice, and the Limits of Capitalism*. Berkeley, CA: University of California Press.

This book critiques the efforts and focus on addressing obesity. It also explores why the food system creates cheap and processed foods, why we consumer it and how the food movements solution of going lo-cal and fresh is reproduces inequalities.

Guthman, Julie. 2004. *Agrarian Dreams: The Paradox of Organic Farming in California*. Berkeley, CA: University of California Press.

This book summarizes the research of one of the first comprehensive studies of organics. It outlines how the ideas of organics are not necessarily manifesting as hoped, at least in California. The ideal of small-scale family growers is not as evident as the industrialization of organics.

Harper, Althea, Alison Alkon, Annie Shattuck, Eric Holt-Giménez, and Frances Lambrick. 2009. *Food Policy Councils: Lessons Learned*. Food First Development Report #21 Dec. 2009. foodfirst.org/publication/food-policy-councils-lessons-learned/

Holmes, Seth. 2013. *Fresh Fruit, Broken Bodies: Migrant Farmworkers in the United States*. Berkeley, CA: University of California Press.

Based on five years of embedded anthropological research, this book explores the lives of Mexican migrant farmworkers. The author documents their experiences, having traveled with the farmworkers from Oaxaca up to the west coast of California. It includes the experience of border crossing, working in the fields, attempting to get medical care, and of daily lives. The author also provides deepening “. . . understanding of the ways in which socially structured suffering comes to be perceived as normal and natural in society and in health care, especially through imputations of ethnic body difference.”

Holt-Giménez, Eric, and Annie Shattuck. 2011a. Food crises, food regimes and food movements: rumblings of re-form or tides of transformation? *The Journal of Peasant Studies* 38: 1, 109–144

Holt-Giménez, Eric, and Annie Shattuck. 2011b. *Occupy the Food System: Building a Vision of Transformation*. Oakland, CA: Food First Backgrounder, Nov 2011. foodfirst.org/publication/occupy-the-food-system-building-a-vision-of-transformation/

Holt-Giménez, Eric and Yee Wang. 2011. Reform or transformation? The pivotal role of food justice in the U.S. food movement. *Race/Ethnicity: Multidisciplinary Global Contexts* 5:1, Food Justice (Autumn 2011), pp. 83-102.

Holt-Giménez, Eric (Editor). 2011. *Food Movements Unite! Strategies to Transform Our Food System*. Oakland, CA: Food First Books.

This book highlights the many efforts worldwide to transform the food system. Twenty-one people working for change have contributed to the chapters, from farmers to consumers, urban and rural, all bring us a glimpse of the “unprecedented ‘movement of movements.’”

Holt-Giménez, Eric. 2010. *Food Security, Food Justice, or Food Sovereignty?* Oakland, CA: Food First Backgrounder, Winter 2010. foodfirst.org/publication/food-security-food-justice-or-food-sovereignty/

Holt-Giménez, Eric and Loren Peabody. 2008. *From Food Rebellions to Food Sovereignty: Urgent Call to Fix a Broken Food System*. Oakland, CA: Food First Backgrounder, Spring 2008. foodfirst.org/publication/from-food-rebellions-to-food-sovereignty-urgent-call-to-fix-a-broken-food-system/

Jayaraman, Saru. 2013. *Behind the Kitchen Door*. Cornell University Press.

The author unveils the extent to which food service workers live below the poverty line, endure illegal treatment (withholding of wages and overtime pay), and experience race and gender discrimination. She also points out how even restaurants focused on qualities of the food movement, such as promoting local and sustainable, don't necessarily treat their employees well or even fairly. She also points to the many reasons why it matters—human rights and dignity—to the simple correlation in research that restaurants that don't treat their workers well are more likely to have health-related food practice violations. Very engaging to read. Stories can be useful for class discussions. She also provides potential solutions, with her primary goal to improve the lives of those working in the food service industry.

Meter, Ken. 2011. Local foods are key to economic recovery. In *Food Movements Unite! Strategies to Transform Our Food Systems*. Oakland, CA: Food First Books.

Murphy, Catherine. 1999. *Cultivating Havana: Urban Agriculture and food Security in Years of Crisis*. Oakland, CA: Food First Development Report No.12, May 1999. foodfirst.org/publication/cultivating-havana-urban-agriculture-and-food-security-in-the-years-of-crisis/

Patel, Raj. 2012. *Survival Pending Revolutions: What the Black Panthers Can Teach the U.S. Food Movement*. Oakland, CA: Food First Backgrounder, Summer 2012. foodfirst.org/publication/survival-pending-revolution-what-the-black-panthers-can-teach-the-us-food-movement/

Pollan, Michael. 2010. Food Movement Rising. *New York Review of Books*, June 10, 2010.

This short article outlines the rising discontent with our current food system and describes aspects of the “movement,” or multiple efforts working to address the problems from different vantage points. What is included in

the movement in this article is drawn from the books he is reviewing, so it is not all inclusive.

Shattuck, Annie, Heidi Conner, Juliana Mandell, and Meera Velu, 2008. *The Food Crisis Comes Home: Empty Food Banks, Rising Costs—Symptoms of a Hungrier Nation*. Oakland, CA: Food First Backgrounder, Fall 2008. foodfirst.org/publication/the-food-crisis-comes-home-empty-food-banks-rising-costs-hungrier-nation/

Steele, Anim. 2010. *Youth and Food Justice: Lessons from the Civil Rights Movement*. Oakland, CA: Food First Backgrounder, Fall 2010. foodfirst.org/publication/youth-and-food-justice-lessons-from-the-civil-rights-movement/

Toi. 2013. *Frankly Not About Food Forests*. www.blackgirldangerous.org/2013/09/frankly-not-about-food-forests/

The author, a community activist and organizer, identifies several ways in which the work of white people on food system issues in communities of color can be problematic. Toi's narrative addresses historical and current structural racism and discrimination facing people of color in relation to the food system, and related feelings associated with this long history.

Viertel, Josh. 2012. *Beyond Voting with Your Fork: From Enlightened Eating to Movement Building*. Oakland, CA: Food First Backgrounder, Spring 2012. foodfirst.org/publication/beyond-voting-with-your-fork-from-enlightened-eating-to-movement-building/

Wang, Yi, Eric Holt-Giménez and Annie Shattuck. 2011. *Grabbing the Food Deserts*. Oakland, CA: Food First Backgrounder, Spring 2011. foodfirst.org/publication/grabbing-the-food-deserts/

VIDEO

Food Chains: The Revolution in America's Fields. 2014. Directed by Sanjay Rawal.

www.foodchainsfilm.com

The narrative of the film focuses on the efforts of the Coalition of Immokalee Workers or CIW, a group of tomato pickers from Southern Florida who are working to create more justice labor conditions.